

# HP Officejet J5500

## User Guide





# HP Officejet J5500 All-in-One series

## User Guide



## Copyright information

© 2007 Copyright Hewlett-Packard Development Company, L.P.

## Hewlett-Packard Company notices

The information contained in this document is subject to change without notice.

All rights reserved. Reproduction, adaptation, or translation of this material is prohibited without prior written permission of Hewlett-Packard, except as allowed under copyright laws.

The only warranties for HP products and services are set forth in the express warranty statements accompanying such products and services. Nothing herein should be construed as constituting an additional warranty. HP shall not be liable for technical or editorial errors or omissions contained herein.

## Acknowledgements

Windows and Windows XP are U.S. registered trademarks of Microsoft Corporation. Windows Vista is either a registered trademark or trademark of Microsoft Corporation in the United States and/or other countries.

Adobe® and Acrobat® are trademarks of Adobe Systems Incorporated.

## Safety information



Always follow basic safety precautions when using this product to reduce risk of injury from fire or electric shock.

1. Read and understand all instructions in the documentation that comes with the device.
2. Use only a grounded electrical outlet when connecting this product to a power source. If you do not know whether the outlet is grounded, check with a qualified electrician.
3. Observe all warnings and instructions marked on the product.
4. Unplug this product from wall outlets before cleaning.
5. Do not install or use this product near water, or when you are wet.
6. Install the product securely on a stable surface.
7. Install the product in a protected location where no one can step on or trip over the line cord, and the line cord cannot be damaged.
8. If the product does not operate normally, see [Maintain and troubleshoot](#).
9. There are no user-serviceable parts inside. Refer servicing to qualified service personnel.

## Accessibility

The device provides a number of features that make it accessible for people with disabilities.

### Visual

The device software is accessible for users with visual impairments or low vision through the use of your operating system's accessibility options and features. It also supports most assistive technology such as screen readers, Braille readers, and voice-to-text applications. For users who are color blind, colored buttons and tabs used in the software and on the control panel have simple text or icon labels that convey the appropriate action.

### Mobility

For users with mobility impairments, the device software functions can be executed through keyboard commands. The software also supports Windows accessibility options such as StickyKeys, ToggleKeys, FilterKeys, and MouseKeys. The device doors, buttons, paper trays, and paper guides can be operated by users with limited strength and reach.

### Support

For more details about the accessibility of this product and HP's commitment to product accessibility, visit HP's Web site at [www.hp.com/accessibility](http://www.hp.com/accessibility).

---

# Contents

## 1 Get started

Find other resources for the product .....	7
Understand the device parts.....	8
Front view.....	8
Printing supplies area.....	8
Back view.....	9
Control panel buttons and lights.....	9
Connection information.....	10

## 2 Use the device

Use control panel menus.....	11
Control-panel message types.....	11
Status messages.....	12
Warning messages.....	12
Error messages.....	12
Critical error messages.....	12
Change device settings.....	12
Use the HP Solution Center .....	13
Use the HP photo and imaging software.....	13
Text and symbols.....	14
Type numbers and text on the control-panel keypad.....	14
To enter text.....	15
To enter a space, pause, or symbol.....	15
To erase a letter, number, or symbol.....	15
Available symbols for dialing fax numbers.....	15
Load originals.....	16
Load an original in the automatic document feeder (ADF).....	16
Load an original on the scanner glass.....	17
Select print media.....	18
Tips for selecting and using print media.....	18
Understand specifications for supported media.....	19
Understand supported sizes.....	19
Understand supported media types and weights.....	20
Set minimum margins.....	20
Load media.....	20
Load full-size paper.....	21
Load 10 x 15 cm (4 x 6 inch) photo paper.....	23
Load index cards.....	24
Load envelopes.....	25
Load other types of paper.....	26
Print on special and custom-sized media.....	27
Print borderless.....	27

Set up speed-dial entries.....	28
Set up fax numbers as speed-dial entries or groups.....	28
Set up speed-dial entries.....	28
Set up a speed-dial group.....	28
Print and view a list of speed-dial entries.....	29
View a list of speed-dial entries.....	29
<b>3 Print</b>	
Change print settings.....	30
Change settings from an application for current jobs.....	30
Change default settings for all future jobs.....	30
Print on both sides (duplexing).....	30
Guidelines for printing on both sides of a page.....	31
Perform duplexing.....	31
Cancel a print job.....	31
<b>4 Copy</b>	
Make copies from the control panel.....	32
Change the copy settings.....	32
Set the number of copies.....	33
Set the copy paper size.....	33
Set the copy paper type from the control panel.....	33
Change copy speed or quality from the control panel.....	34
Resize an original to fit onto letter or A4 paper.....	35
Copy a legal-size document onto letter paper.....	35
Adjust the lightness and darkness of your copy.....	36
Enhance blurred areas of your copy.....	36
Enhance light areas of your copy from the control panel.....	37
Cancel a copy job.....	37
<b>5 Scan</b>	
Scan an original.....	38
Scan an original to a program on a computer.....	38
Scan from a TWAIN-compliant or a WIA-compliant program.....	39
Scan from a TWAIN-compliant program.....	39
Scan from a WIA-compliant program.....	39
Edit a scanned original.....	39
Edit a scanned photo or graphic.....	40
Edit a scanned document using optical character recognition (OCR) software.....	40
Change scan settings.....	40
Cancel a scan job.....	40

**6 Fax**

Send a fax.....41

- Send a basic fax.....41
- Send a fax manually from a phone.....42
- Send a fax using monitor dialing.....43
- Send a fax from memory.....44
- Schedule a fax to send later.....45
- Send a fax to multiple recipients from the control panel.....45
- Send a color original or photo fax.....47
- Change the fax resolution and **Lighter / Darker** settings.....47
  - Change the fax resolution.....48
  - Change the **Lighter / Darker** setting.....49
  - Set new default settings.....50
- Send a fax in Error Correction Mode.....50

Receive a fax.....50

- Receive a fax manually.....51
- Set up backup fax reception.....51
- Reprint received faxes from memory.....52
- Poll to receive a fax.....52
- Forward faxes to another number.....53
- Set the paper size for received faxes.....54
- Set automatic reduction for incoming faxes.....54
- Block junk fax numbers.....54
  - Set the junk fax mode.....55
  - Add numbers to the junk fax list.....55
  - Remove numbers from the junk fax list.....56

Change fax settings.....56

- Configure the fax header.....56
- Set the answer mode (Auto answer).....57
- Set the number of rings before answering.....57
- Change the answer ring pattern for distinctive ring.....57
- Set the fax error correction mode.....58
- Set the dial type.....58
- Set the redial options.....58
- Set the fax speed.....59

Fax over the Internet.....59

Test fax setup.....60

Use reports.....60

- Print fax confirmation reports.....61
- Print fax error reports.....61
- Print and view the fax log.....61

Cancel a fax.....62

**7 Configure and manage**

Manage the device.....63

- Monitor the device.....63
- Administer the device.....64

Use device management tools.....64

- Toolbox.....64
- Toolbox tabs .....65

- Set up faxing for the device.....65
- Set up faxing (parallel phone systems).....66
  - Choose the correct fax setup for your home or office.....66
  - Select your fax setup case.....68
  - Case A: Separate fax line (no voice calls received).....69
  - Case B: Set up the device with DSL.....70
  - Case C: Set up the device with a PBX phone system or an ISDN line.....71
  - Case D: Fax with a distinctive ring service on the same line.....72
  - Case E: Shared voice/fax line.....73
  - Case F: Shared voice/fax line with voice mail.....74
  - Case G: Fax line shared with computer modem (no voice calls received).....75
  - Case H: Shared voice/fax line with computer modem.....77
  - Case I: Shared voice/fax line with answering machine.....81
  - Case J: Shared voice/fax line with computer modem and answering machine.....82
  - Case K: Shared voice/fax line with computer dial-up modem and voice mail.....87
- Serial-type fax setup.....88
- Configure the device.....89
  - Direct connection.....89
    - Install the software before connecting the device (recommended).....90
    - Connect the device before installing the software.....90
    - Share the device on a locally shared network.....91
- Uninstall and reinstall the software.....91

**8 Maintain and troubleshoot**

- Work with print cartridges.....93
  - Supported print cartridges.....93
  - Handle the print cartridges.....94
  - Replace the print cartridges.....94
  - Align the print cartridges.....98
  - Calibrate color.....99
  - Clean the print cartridges.....99
  - Clean the print cartridge contacts.....100
  - Clean the area around the ink nozzles.....101
  - Use a photo print cartridge.....103
  - Store printing supplies.....103
    - Store print cartridges.....103
    - Use the print cartridge protector.....103
- Clean the device.....104
  - Clean the glass.....104
  - Clean the lid backing.....105
  - Clean the exterior.....105
  - Clean the automatic document feeder.....106
- Troubleshooting tips and resources.....108
- Solve printing problems.....109
  - The device shuts down unexpectedly.....109
  - Error message appears on control-panel display.....109
  - The device is not responding (nothing prints).....109
  - Device takes a long time to print.....110
  - Blank or partial page printed.....110
  - Something on the page is missing or incorrect.....110
  - Placement of the text or graphics is wrong.....111



## Contents

Poor print quality and unexpected printouts.....	111
Poor quality printouts.....	112
Meaningless characters print.....	112
Ink is smearing.....	113
Ink is not filling the text or graphics completely.....	113
Output is faded or dull colored.....	113
Colors are printing as black and white.....	113
Wrong colors are printing.....	114
Printout shows bleeding colors.....	114
Colors do not line up properly.....	114
Lines or dots are missing from text or graphics.....	114
Solve paper-feed problems.....	114
Media is not supported for the printer or tray.....	114
Media is not picked up from a tray.....	115
Media is not coming out correctly.....	115
Pages are skewing.....	115
Multiple pages are being picked up.....	115
Solve copy problems.....	116
No copy came out.....	116
Copies are blank.....	116
Wrong original was copied.....	116
Documents are missing or faded.....	116
Size is reduced.....	117
Copy quality is poor.....	117
Copy defects are apparent.....	117
Error messages appear.....	118
Solve scan problems.....	118
Scanner did nothing.....	118
Scan takes too long.....	118
Part of the document did not scan or text is missing.....	119
Text cannot be edited.....	119
Error messages appear.....	120
Scanned image quality is poor.....	120
Scan defects are apparent.....	121
Solve fax problems.....	121
The fax test failed.....	122
Troubleshoot installation issues.....	132
Hardware installation suggestions.....	133
Software installation suggestions.....	133
Clear paper jams.....	134
Avoid paper jams.....	135
<b>A HP supplies</b>	
Order printing supplies online.....	137
Supplies.....	137
Print cartridges.....	137
HP media.....	137
<b>B Support and warranty</b>	
Hewlett-Packard limited warranty statement.....	139
Obtain electronic support.....	140

Obtain HP telephone support.....	140
Before you call.....	140
Support process.....	140
HP support by phone.....	141
Phone support period.....	141
Telephone support numbers.....	141
Placing a call.....	142
After the phone support period.....	143
Additional warranty options.....	143
Prepare the device for shipment.....	143
Remove the print cartridges before shipment.....	143
Remove the control-panel faceplate.....	145
Pack the device.....	146
<b>C Device specifications</b>	
Physical specifications.....	147
Product features and capacities.....	147
Memory specifications.....	147
System requirements.....	148
Print specifications.....	148
Copy specifications.....	148
Fax specifications.....	149
Scan specifications.....	149
Environmental specifications.....	149
Electrical specifications.....	150
Acoustic emission specifications (noise levels per ISO 7779).....	150
<b>D Regulatory information</b>	
FCC statement.....	152
Notice to users in Korea.....	152
VCCI (Class B) compliance statement for users in Japan.....	152
Notice to users in Japan about the power cord.....	153
Noise emission statement for Germany.....	153
RoHS notices (China only).....	153
Notice to users of the U.S. telephone network: FCC requirements.....	154
Notice to users of the Canadian telephone network.....	154
Notice to users in the European Economic Area.....	156
Australia wired fax statement.....	156
Warning for Australia and New Zealand with phone handset.....	156
Declaration of conformity.....	157
Regulatory model number.....	157
Environmental product stewardship program.....	158
Paper use.....	158
Plastics.....	158
Material safety data sheets.....	158
Recycling program.....	158
HP inkjet supplies recycling program.....	158
Disposal of waste equipment by users in private households in the European Union.....	159
Energy consumption.....	159
<b>Index</b> .....	161

# 1 Get started

This guide provides details about how to use the device and to resolve problems.

- [Find other resources for the product](#)
- [Understand the device parts](#)

## Find other resources for the product

You can obtain product information and further troubleshooting resources that are not included in this guide from the following resources:

Resource	Description	Location
Setup poster	Provides illustrated setup information.	A printed version of the document is provided with the device.
Fax Getting Started Guide	Provides instructions for setting up the device and information about the warranty and safety issues.	A printed version of the document is provided with the device.
Readme file and release notes	Provide late-breaking information and troubleshooting tips.	Included on the Starter CD.
Toolbox	Provides information about print cartridges and access to maintenance services. For more information, see <a href="#">Toolbox</a> .	The Toolbox is typically installed with the device software as an available installation option.
Control panel	Provides status, error, and warning information about operations.	For more information, see <a href="#">Control panel buttons and lights</a> .
Logs and reports	Provides information about events that have occurred.	For more information, see <a href="#">Monitor the device</a> .
HP Web sites	Provide the latest printer software, and product and support information.	<a href="http://www.hp.com/support">www.hp.com/support</a> <a href="http://www.hp.com">www.hp.com</a>
HP telephone support	Lists information to contact HP. During the warranty period, this support is often free of charge.	For more information, see <a href="#">Obtain HP telephone support</a> .
HP photo and imaging software help	Provides information about using the software.	For more information, see <a href="#">Use the HP photo and imaging software</a> .

## Understand the device parts

- [Front view](#)
- [Printing supplies area](#)
- [Back view](#)
- [Control panel buttons and lights](#)
- [Connection information](#)

### Front view



1	Automatic document feeder (ADF)
2	Control panel
3	Output tray
4	Output tray extender
5	Input tray
6	Print cartridge door
7	Scanner lid
8	Document feeder tray
9	Scanner glass

### Printing supplies area

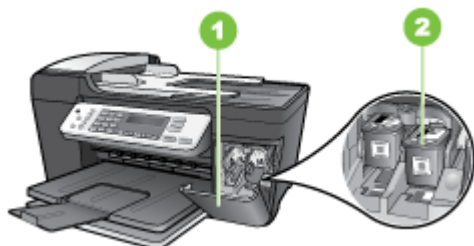

1	Print-cartridge door
2	Print cartridges

## Back view

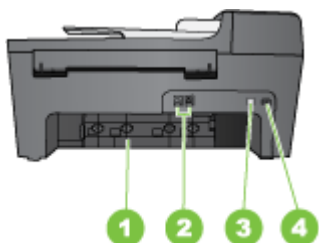

1	Rear door
2	Fax ports (1-LINE and 2-EXT)
3	Power connection
4	Rear universal serial bus (USB) port

## Control panel buttons and lights

The following diagram and related table provide a quick reference to the control panel features.

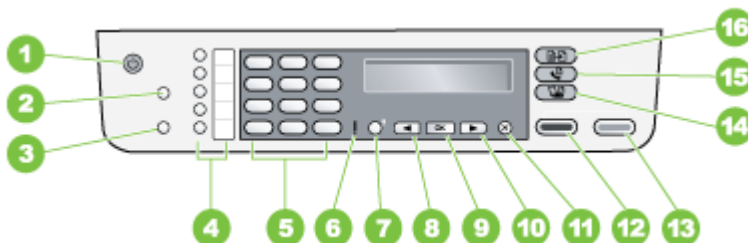

Label	Name and Description
1	<b>On:</b> Turn the HP All-in-One on or off. The On button is lit when the device is on. The light blinks while performing a job.  When the HP All-in-One is off, a minimal amount of power is still supplied to the device. To completely disconnect the power supply to the HP All-in-One, turn the device off, and then unplug the power cord.
2	<b>Speed Dial:</b> Select a speed dial number.
3	<b>Redial/Pause:</b> Redial the most recently dialed number, or insert a 3-second pause in a fax number.
4	<b>One-touch speed dial buttons:</b> Access the first five speed dial numbers.

Label	Name and Description
5	<b>Keypad:</b> Enter fax numbers, values, or text.
6	<b>Attention light:</b> When blinking, the attention light indicates an error has occurred that requires your attention.
7	<b>Setup/?:</b> Presents or removes the <b>Setup Menu</b> for generating reports, changing fax and other maintenance settings, and accessing the <b>Help</b> menu. The topic that you select from the <b>Help</b> menu opens a help window on your computer screen.
8	<b>Left arrow:</b> Decrease values on the control panel display.
9	<b>OK:</b> Select a menu or a setting in the control panel display.
10	<b>Right arrow:</b> Increase values on the control panel display.
11	<b>Cancel:</b> Stop a job, exit a menu, or exit settings.
12	<b>Start Black:</b> Start a black-and-white copy, scan, photo print, or fax job.
13	<b>Start Color:</b> Start a color copy, scan, photo print, or fax job.
14	<b>Scan:</b> Presents the <b>Scan To</b> menu for selecting a scan destination.
15	<b>Fax:</b> Presents the <b>Fax Menu</b> for selecting options.
16	<b>Copy:</b> Presents the <b>Copy Menu</b> for selecting options.

## Connection information

Description	Recommended number of connected computers for best performance	Supported software features	Setup instructions
USB connection	One computer connected with a USB cable to the rear USB 2.0 high-speed port on the device.	All features are supported.	Follow the setup poster for detailed instructions.
Printer sharing	Up to five computers. The host computer must be turned on at all times, or the other computers cannot print to the device.	All features resident on the host computer are supported. Only print is supported from the other computers.	Follow the instructions in <a href="#">Share the device on a locally shared network</a> .

---

## 2 Use the device

This section contains the following topics:

- [Use control panel menus](#)
- [Control-panel message types](#)
- [Change device settings](#)
- [Use the HP Solution Center](#)
- [Use the HP photo and imaging software](#)
- [Text and symbols](#)
- [Load originals](#)
- [Select print media](#)
- [Load media](#)
- [Print on special and custom-sized media](#)
- [Print borderless](#)
- [Set up speed-dial entries](#)

### Use control panel menus

The following section provides a quick reference to top-level menus that appear on the control-panel display. To display a menu, press the menu button for the function you want to use.

- **Scan menu:** Presents a list of destinations; for example, HP photo and imaging software.
- **Fax menu:** Allows you to enter a fax or speed-dial number, or display the Fax menu. Menu options include:
  - Modifying resolution
  - Lightening/darkening
  - Sending delayed faxes
  - Setting up new defaults
- **Copy menu:** Menu options include:
  - Selecting copy quantities
  - Reducing/enlarging
  - Selecting media type and size

### Control-panel message types

This section contains the following topics:

- [Status messages](#)
- [Warning messages](#)
- [Error messages](#)
- [Critical error messages](#)

## Status messages

Status messages reflect the current state of the device. They inform you of normal operation and require no action to clear them. They change as the state of the device changes. Whenever the device is ready, not busy, and has no pending warning messages, the status message **READY** appears if the device is turned on.

## Warning messages

Warning messages inform you of events that require your attention, but they do not prevent the device from operating. An example of a warning message is a low ink warning. These messages appear until you resolve the condition.

## Error messages

Error messages communicate that some action must be performed, such as adding media or clearing a media jam. These messages are usually accompanied by a blinking red Attention light. Take the appropriate action to continue printing.

If the error message shows an error code, press the Power button to turn off the device, and then turn it on again. In most situations, this action solves the problem. If the message persists, your device might need service. Write down the error code, and then go to HP Support to learn more about possible causes for the message. For more information, see [Obtain electronic support](#).

## Critical error messages

Critical error messages inform you of a device failure. Some of these messages can be cleared by pressing the Power button to turn off the device, and then turning it on again. If a critical error persists, service is required. For more information, see [Support and warranty](#).

## Change device settings

You can change the device settings from these places:

- From the control panel.
- From the HP Solution Center. For more information, see [Use the HP photo and imaging software](#).

---

 **NOTE:** When you are configuring settings in HP Solution Center, you cannot see the settings that have been configured from the control panel (such as the scan settings).

---



### **To change settings from the control panel**

1. At the control panel, press the menu button for the function you are using (for example, Copy Menu).
2. To reach the option that you want to change, use one of the following methods:
  - Press a control-panel button, and then use the left or right arrow keys to adjust the value.
  - Select the option from the menu on the control-panel display.
3. Select the value that you want, and then press **OK**.

### **To change settings from the HP Solution Center**

- ▲ See [Use the HP photo and imaging software](#).

## **Use the HP Solution Center**

HP Solution Center is the entry point for the HP Photosmart Software. Use the HP Solution Center to change print settings, start the Fax Setup Wizard, order supplies, and access the onscreen Help.

The features available in the HP Solution Center vary depending on the devices you have installed. The HP Solution Center is customized to show icons that are associated with the selected device. If the selected device is not equipped with a particular feature, then the icon for that feature does not appear in the HP Solution Center.

If the HP Solution Center on your computer does not contain any icons, an error might have occurred during the software installation. To correct this, use the Control Panel in Windows to completely uninstall the HP Photosmart Software, and then reinstall the software. For more information, see the onscreen Help that came with the device.

For information about opening the HP Solution Center, see [Use the HP photo and imaging software](#).

## **Use the HP photo and imaging software**

You can use the HP photo and imaging software to access many features that are not available from the control panel.

The software is installed on your computer during setup. For further information, see the setup documentation that came with your device.

The HP photo and imaging software entry point is the HP Photosmart Software window.

### To open the HP Photosmart Software

1. Do one of the following:
  - On the Windows desktop, double-click the HP Photosmart Software icon.
  - In the system tray at the far right of the Windows taskbar, double-click the **HP Digital Imaging Monitor** icon.
  - On the taskbar, click **Start**, point to **Programs** or **All Programs**, select **HP**, and then click the HP Photosmart Software.
2. If you have more than one HP device installed, select the tab with your product's name.

---

 **NOTE:** On a Windows computer, the features available in the HP Photosmart Software vary depending on the devices you have installed. The software is customized to show icons that are associated with the selected device. If the selected device is not equipped with a particular feature, then the icon for that feature does not appear in the software.

 **TIP:** If the HP Photosmart Software on your computer does not contain any icons, an error might have occurred during the software installation. To correct this, use the Control Panel in Windows to completely uninstall the HP Photosmart Software; then reinstall the software. For more information, see the Getting Started Guide that came with your device.

---

## Text and symbols

You can use the keypad on the control panel to enter text and symbols. You can also enter text and symbols from the control panel by using the visual keyboard. The visual keyboard appears automatically on the color display when you set up the fax header or speed dial entries.

You can also enter symbols from the keypad when you dial a fax or phone number. When the device dials the number, it interprets the symbol and responds accordingly. For example, if you enter a dash in the fax number, the device will pause before dialing the remainder of the number. A pause is useful if you need to gain access to an outside line before dialing the fax number.

---

 **NOTE:** If you want to enter a symbol in your fax number, such as a dash, you need to enter the symbol by using the keypad.

---

### Type numbers and text on the control-panel keypad

You can enter text or symbols by using the keypad on the control panel.

After you are done entering text, press **OK** to store your entry.

### To enter text

1. Press the keypad numbers that correspond to the letters of a name. For example, the letters a, b, and c correspond to the number 2, as shown on the button below.



---

 **TIP:** Press a button multiple times to see the available characters. Depending on your language and country/region setting, other characters might be available in addition to the ones shown on the keypad.

---

2. After the correct letter appears, wait for the cursor to advance automatically to the right, or press the right arrow button. Press the number that corresponds to the next letter in the name. Press the button multiple times until the correct letter appears. The first letter of a word is automatically set to uppercase.

### To enter a space, pause, or symbol

- To insert a space, press **Space**.
- To enter a pause, press **Redial/Pause**. A dash appears in the number sequence.
- To enter a symbol, such as @, press the **Symbols** button repeatedly to scroll through the list of available symbols: asterisk (\*), dash (-), ampersand (&), period (.), slash (/), parentheses ( ), apostrophe ('), equals (=), number sign (#), at (@), underscore (\_), plus (+), exclamation (!), semicolon (;), question (?), comma (,), colon (:), percent (%), and approximation (~).

### To erase a letter, number, or symbol

- ▲ If you make a mistake, press the left arrow button to clear it, and then make the correct entry.

## Available symbols for dialing fax numbers

To enter a symbol, such as \*, press **Symbols** repeatedly to scroll through the list of symbols. The following table provides the symbols that you can use in a fax or phone number sequence, fax header information, and speed-dial entries.

Available symbols	Description	Available when entering
*	Displays an asterisk symbol when required for dialing.	Fax header name, speed-dial names, speed-dial numbers, fax or phone numbers, and monitor dial entries
-	When auto-dialing, the device enters a pause in the number sequence.	Fax header name, fax header number, speed-dial names, speed-dial numbers, and fax or phone numbers
( )	Displays a left or right parenthesis to separate numbers, such as area codes, for easier reading. These symbols do not affect dialing.	Fax header name, fax header number, speed-dial names, speed-dial numbers, and fax or phone numbers

(continued)

Available symbols	Description	Available when entering
W	When auto-dialing, W causes the device to wait for a dial tone before continuing to dial.	Speed-dial numbers and fax or phone numbers
R	During auto-dialing, the R functions the same as a Flash button on your telephone.	Speed-dial numbers and fax or phone numbers
+	Displays a plus symbol. This symbol does not affect dialing.	Fax header name, fax header number, speed-dial names, speed-dial numbers, and fax or phone numbers

## Load originals

You can load an original for a copy, fax, or scan job in the automatic document feeder or on the scanner glass. Originals that are loaded in the automatic document feeder are automatically fed into the device.

### Load an original in the automatic document feeder (ADF)

You can copy, scan, or fax a one-sided, single- or multiple-page, A4- or letter-size document by placing it in the document feeder tray.

---

 **CAUTION:** Do not load photos in the ADF; this might cause damage to your photos.

---

The document feeder tray holds a maximum of 25 sheets of plain paper.

#### To load an original in the document feeder tray

1. Load your original, with the print side up, into the document feeder tray. Place the pages so that the top edge of the document goes in first. Slide the media into the automatic document feeder until you hear a beep or see a message on the display indicating that the loaded pages were detected.

The automatic document feeder holds a maximum of 25 sheets of plain paper.

---

 **TIP:** For more help on loading originals in the automatic document feeder, refer to the diagram engraved in the document feeder tray.

---



2. Slide the width guides inward until they stop at the left and right edges of the media.

---

 **NOTE:** Remove all originals from the document feeder tray before lifting the lid on the device.

---

### Load an original on the scanner glass

You can copy, scan, or fax originals up to legal-size by loading them on the glass. If your original contains multiple full-size pages, use the automatic document feeder.

---

 **NOTE:** Many of the special features will not work correctly if the glass and lid backing are not clean. For more information, see [Clean the device](#).

---

### To load an original on the scanner glass

1. Remove all originals from the document feeder tray, and then lift the lid.
2. Load your original print side down in the right front corner of the glass.

---

 **TIP:** For more help on loading an original, refer to the engraved guides along the edge of the glass.

---



3. Close the lid.

## Select print media

The device is designed to work well with most types of office media. It is best to test a variety of print media types before buying large quantities. Use HP media for optimum print quality. Visit the HP Web site at [www.hp.com](http://www.hp.com) for more information about HP media.

### Tips for selecting and using print media

For the best results, observe the following guidelines.

- Always use media that conforms to the device specifications. For more information, see [Understand specifications for supported media](#).
- Load only one type of media at a time into the input tray.
- Load media print-side down and aligned against the right and back edges of the input tray. For more information, see [Load media](#).
- Do not overload the input tray. For more information, see [Understand specifications for supported media](#).
- To prevent jams, poor print quality, and other printing problems, avoid the following media:
  - Multipart forms
  - Media that is damaged, curled, or wrinkled
  - Media with cutouts or perforations
  - Media that is heavily textured, embossed, or does not accept ink well
  - Media that is too lightweight or stretches easily

### Cards and envelopes

- Avoid envelopes that have a very slick finish, self-stick adhesives, clasps, or windows. Also avoid cards and envelopes with thick, irregular, or curled edges, or areas that are wrinkled, torn, or otherwise damaged.
- Use tightly constructed envelopes, and make sure the folds are sharply creased.
- Load envelopes with the flaps facing up.

### Photo media

- Use the **Best** mode to print photographs. Note that in this mode, printing takes longer and more memory is required from your computer.
- Remove each sheet as it prints and set it aside to dry. Allowing wet media to stack up may cause smearing.

## Transparencies

- Insert transparencies with the rough side down and the adhesive strip pointing towards the back of the device.
- Use the **Normal** mode to print transparencies. This mode provides longer drying time and ensures that the ink dries completely before the next page is delivered to the output tray.
- Remove each sheet as it prints and set it aside to dry. Allowing wet media to stack up may cause smearing.

## Custom-sized media

- Use only custom-sized media that is supported by the device.
- If your application supports custom-sized media, set the media size in the application before printing the document. If not, set the size in the print driver. You might need to reformat existing documents to print them correctly on custom-sized media.

## Understand specifications for supported media

Use the [Understand supported sizes](#) and [Understand supported media types and weights](#) tables to determine the correct media to use with your device, and determine what features will work with your media.

- [Understand supported sizes](#)
- [Understand supported media types and weights](#)

## Understand supported sizes

Type	Size
Paper	Letter: 216 x 280 mm (8.5 x 11 inches) A4: 210 x 297 mm Legal: 216 x 356 mm (8.5 x 14 inches)
Envelopes	U.S. #10: 105 x 241 mm (4.125 x 9.5 inches) U.S. #9: 98 x 225 mm (3.9 x 8.9 inches) A2: 111 x 146 mm (4.4 x 5.8 inches) DL: 110 x 220 mm (4.3 x 8.7 inches) C6: 114 x 162 mm (4.5 x 6.4 inches)
Transparency film	Letter: 216 x 279 mm (8.5 x 11 inches) A4: 210 x 297 mm
Premium photo paper	102 x 152 mm (4 x 6 inches) Letter: 216 x 280 mm (8.5 x 11 inches) A4: 210 x 297 mm
Cards	Index card: 101 x 152 mm (4 x 6 inches)
Labels	Letter: 216 x 279 mm (8.5 x 11 inches) A4: 210 x 297 mm

(continued)

Type	Size
Custom	102 x 152 mm up to 216 x 356 mm (4 x 6 inches up to 8.5 x 14 inches)

### Understand supported media types and weights

Type	Paper weight	Input tray*	Output tray**	Document feeder tray
Plain paper	20 to 24 lb. (75 to 90 gsm)	up to 100	up to 50	up to 25
Legal paper	20 to 24 lb. (75 to 90 gsm)	up to 100	up to 50	up to 25
Cards	up to 110 lb. index (200 gsm)	up to 20	up to 10	N/A
Envelopes	20 to 24 lb. (75 to 90 gsm)	up to 10	up to 5	N/A
Transparency film	N/A	up to 30	up to 15	N/A
Labels	N/A	up to 20	up to 10	N/A
4 x 6 inch photo paper	up to 75 lb. (280 gsm)	up to 30	up to 15	N/A
8.5 x 11 inch photo paper	N/A	up to 30	up to 15	N/A

\* Maximum capacity.

\*\* Output tray capacity is affected by the type of paper and the amount of ink you are using. HP recommends emptying the output tray frequently.

### Set minimum margins

	Top (leading edge)	Bottom (trailing edge)	Left and Right margins
U.S. (Letter, Legal, Executive)	1.8 mm (0.07 inches)	6.7 mm (0.3 inches)	1.5 mm (0.06 inches)
ISO (A4, A5) and JIS (B5)	1.8 mm (0.07 inches)	6.7 mm (0.3 inches)	1.5 mm (0.06 inches)
Envelopes	1.8 mm (0.07 inches)	6.7 mm (0.3 inches)	1.5 mm (0.06 inches)
Cards	1.8 mm (0.07 inches)	6.7 mm (0.3 inches)	1.5 mm (0.06 inches)

## Load media

This section describes the procedure for loading different types and sizes of paper into the device for your copies, printouts, or faxes.



---

 **TIP:** To help prevent rips, wrinkles, and curled or bent edges, store all paper flat in a resealable bag. If the paper is not stored properly, extreme changes in temperature and humidity might result in curled paper that does not work well in the device.

---

This section contains the following topics:

- [Load full-size paper](#)
- [Load 10 x 15 cm \(4 x 6 inch\) photo paper](#)
- [Load index cards](#)
- [Load envelopes](#)
- [Load other types of paper](#)

## Load full-size paper

You can load many types of letter, A4, or legal paper into the input tray of the device.

### To load full-size paper

1. Remove the output tray.



2. Slide the paper-width guide to its outermost position.



3. Flip the tray extender up toward you.



---

 **NOTE:** When you use legal-size paper, leave the tray extender closed.

---

4. Tap a stack of paper on a flat surface to align the edges, and then check the paper for the following:
  - Make sure it is free of rips, dust, wrinkles, and curled or bent edges.
  - Make sure all the paper in the stack is the same size and type.
5. Insert the stack of paper into the input tray with the short edge forward and the print side down. Slide the stack of paper forward until it stops.



---

 **CAUTION:** Make sure that the device is idle and silent when you load paper into the input tray. If it is servicing the print cartridges or otherwise engaged in a task, the paper stop inside the device might not be in place. You could push the paper too far forward, causing the device to eject blank pages.

 **TIP:** If you are using letterhead, insert the top of the page first with the print side down. For more help on loading full-size paper and letterhead, refer to the diagram engraved in the base of the input tray.

---

- Slide the paper-width guide inward until it stops at the edge of the paper.  
Do not overload the input tray; make sure the stack of paper fits within the input tray and is no higher than the top of the paper-width guide.



- Replace the output tray.



### Load 10 x 15 cm (4 x 6 inch) photo paper

You can load 10 x 15 cm (4 x 6 inch) photo paper into the input tray of the device. For the best results, use 10 x 15 cm (4 x 6 inch) HP Premium Plus Photo Paper or HP Premium Photo Paper.

---

**TIP:** To help prevent rips, wrinkles, and curled or bent edges, store all paper flat in a resealable bag. If the paper is not stored properly, extreme changes in temperature and humidity might result in curled paper that does not work well in the device.

---

For best results, set the paper type and paper size before copying or printing.

#### To load 10 x 15 cm (4 x 6 inch) photo paper with tab in the input tray

- Remove the output tray.
- Remove all paper from the input tray.

3. Insert the stack of photo paper into the far-right side of the input tray with the short edge forward and the print side down. Slide the stack of photo paper forward until it stops.

Load the photo paper so that the tabs are closest to you.

---

 **TIP:** For more help on loading small-size photo paper, refer to the guides engraved in the base of the input tray for loading photo paper.

---

4. Slide the paper-width guide inward against the photo paper until it stops. Do not overload the input tray; make sure the stack of paper fits within the input tray and is no higher than the top of the paper-width guide.



5. Replace the output tray.

## Load index cards

You can load index cards into the input tray of the device to print notes, recipes, and other text.

For best results, set the paper type and paper size before copying or printing.

### To load index cards in the input tray

1. Remove the output tray.
2. Remove all paper from the input tray.
3. Insert the stack of cards, print side down, into the far-right side of the input tray. Slide the stack of cards forward until it stops.

- Slide the paper-width guide inward against the stack of cards until it stops. Do not overload the input tray; make sure the stack of cards fits within the input tray and is no higher than the top of the paper-width guide.



- Replace the output tray.

## Load envelopes

You can load one or more envelopes into the input tray of the device. Do not use shiny or embossed envelopes or envelopes that have clasps or windows.

---

 **NOTE:** For specific details on how to format text for printing on envelopes, consult the help files in your word processing software. For best results, consider using a label for the return address on envelopes.

---

### To load envelopes

- Remove the output tray.
- Remove all paper from the input tray.
- Insert one or more envelopes into the far-right side of the input tray with the envelope flaps up and on the left. Slide the stack of envelopes forward until it stops.

---

 **TIP:** For more help on loading envelopes, refer to the diagram engraved in the base of the input tray.

---

- Slide the paper-width guide inward against the stack of envelopes until it stops. Do not overload the input tray; make sure the stack of envelopes fits within the input tray and is not higher than the top of the paper-width guide.



5. Replace the output tray.

## Load other types of paper

The following papers require extra attention to load them properly.

---

 **NOTE:** Not all paper sizes and paper types are available with all the functions on the device. Some paper sizes and paper types can only be used if you are starting a print job from the **Print** dialog box in a software application. They are not available for copying or faxing. Papers that are only available for printing from a software application are indicated as such.

---

### HP Premium Inkjet Transparency Film and HP Premium Plus Inkjet Transparency Film

- ▲ Insert the film so that the white transparency strip (with arrows and the HP logo) is on top and is going into the input tray first.

---

 **NOTE:** The device cannot automatically detect the paper size or paper type. For best results, set the paper type to transparency film before printing or copying onto transparency film.

---

### HP Iron-On Transfers (for printing only)

1. Flatten the transfer sheet completely before using it; do not load curled sheets.

---

 **TIP:** To prevent curling, keep transfer sheets sealed in the original package until you are ready to use them.

---

2. Locate the blue stripe on the nonprinting side of the transfer paper and then manually feed one sheet at a time into the input tray with the blue stripe facing up.

### HP Greeting Cards, HP Photo Greeting Cards, or HP Textured Greeting Cards (for printing only)

- ▲ Insert a small stack of HP greeting card paper into the input tray with the print side down; slide the stack of cards forward until it stops.

---

 **TIP:** Make sure the area on which you want to print is inserted first, facing down in the input tray.

---

### HP Inkjet labels (for printing only)

1. Always use letter or A4 label sheets designed for use with HP inkjet devices (such as HP inkjet labels), and make sure that the labels are no more than two years old. Labels on older sheets might peel off when the paper is pulled through the device, causing subsequent paper jams.
2. Fan the stack of labels to make sure none of the pages are sticking together.
3. Place a stack of label sheets on top of full-size plain paper in the input tray, label side down. Do not insert labels one sheet at a time.

For best results, set the paper type and paper size before copying or printing.

### Related topics

- [Tips for selecting and using print media](#)
- [Understand specifications for supported media](#)

## Print on special and custom-sized media

### To print on special or custom-sized media

1. Load the appropriate media. For more information, see [Load media](#).
2. With a document open, click **Print** on the **File** menu, and then click **Setup**, **Properties**, or **Preferences**.
3. Click the **Paper/Features** tab.
4. Select the media size from the **Size is** drop-down list.

### To set a custom media size:

- a. Click the **Custom** button.
  - b. Type a name for the new custom size.
  - c. In the **Width** and **Height** boxes, type the dimensions, and then click **Save**.
  - d. Click **OK** twice to close the properties or preferences dialog box. Open the dialog box again.
  - e. Select the new custom size.
5. To select the media type:
    - a. Click **More** in the **Type is** drop-down list.
    - b. Click the desired media type, and then click **OK**.
  6. Change any other settings, and then click **OK**.
  7. Print your document.

## Print borderless

Borderless printing lets you print to the edges of certain media types and a range of standard media sizes.

---

 **NOTE:** Open the file in a software application and assign the image size. Make sure the size corresponds to the media size on which you are printing the image.

You can also gain access to this feature from the **Printing Shortcuts** tab. Open the printer driver, select the **Printing Shortcuts** tab, and select the printing shortcut for this print job drop-down list.

---

1. Load the appropriate media. For more information, see [Load media](#).
2. Open the file that you want to print.
3. From the application, open the print driver:
  - a. Click **File**, and then click **Print**.
  - b. Click **Properties** or **Setup**.
4. Click the **Paper/Quality** tab.
5. Select the media size from the **Size is** drop-down list.
6. Select the **Borderless Printing** check box.

7. Select the media source from the **Source is** drop-down list.
8. Select the media type from the **Type is** drop-down list.
9. If you are printing photos, select **Best** from the **Print Quality** drop-down list. Alternatively, select **Maximum dpi**, which provides up to 4800 x 1200 optimized dpi\* for optimum print quality.  
\*Up to 4800 x 1200 optimized dpi for color printing and 1200 input dpi. This setting might temporarily use a large amount of hard disk space (400 MB or more) and will print more slowly.
10. Change any other print settings, and then click **OK**.
11. Print the document.
12. If you printed on photo media with a tear-off tab, remove the tab to make the document completely borderless.

## Set up speed-dial entries

You can set up frequently used fax numbers as speed-dial entries. This lets you dial those numbers quickly by using the control panel. The first five entries for each of these destinations are associated with the five speed-dial buttons on the control panel.

### Set up fax numbers as speed-dial entries or groups

You can store fax numbers or groups of fax numbers as speed-dial entries. Speed-dial entries 1 through 5 are associated with the corresponding five speed-dial buttons on the control panel.

For information about printing a list of the speed-dial entries that are set up, see [Print and view a list of speed-dial entries](#).

#### Set up speed-dial entries

- **HP Photosmart Software:** Open the HP Photosmart Software and follow the instructions in the onscreen Help.
- **Control panel:** Press **Setup**, and then select the **Speed Dial Setup** option.
  - To add or change an entry: Select **Individual Speed Dial** or **Group Speed Dial** and press the arrow keys to move to an unused entry number, or type a number on the keypad. Type the fax number, and then press **OK**. Include any pauses or other required numbers, such as an area code, an access code for numbers outside a PBX system (usually a 9 or 0), or a long-distance prefix. Type the name, and then press **OK**.
  - To delete one entry or all entries: Select **Delete Speed Dial**, press the arrow keys to highlight the speed-dial entry that you want to delete, and then press **OK**.

#### Set up a speed-dial group

If you send information to the same group of fax numbers on a regular basis, you can set up a speed-dial entry for a group in order to simplify the task. The speed-dial entry for a group can be associated with a speed-dial button on the control panel.



A group member must be a member of the speed-dial list before you can add the member to a speed-dial group. You can add up to 20 fax numbers to each group (with up to 50 characters for each fax number).

- **HP Photosmart Software:** Open the HP Photosmart Software and follow the instructions in the onscreen Help.
- **Control panel:** Press the **Setup** button, and then select the **Speed Dial Setup** option.
  - To add a group: Select **Group Speed Dial**, select an unassigned speed-dial entry, and then press **OK**. Use the arrow keys to highlight a speed-dial entry, and then press **OK** to select it (a check mark appears next to the speed-dial entry). Repeat this step to add additional speed-dial entries to this group. When finished, select the **Done Selecting** option, and then press **OK**. Use the onscreen keyboard to enter a group speed-dial name, and then select **Done**.
  - To add entries to a group: Select **Group Speed Dial**, select the group speed-dial entry that you want to change, and then press **OK**. Use the arrow keys to highlight a speed-dial entry, and then press **OK** to select it (a check mark appears next to the speed-dial entry). Repeat this step to add additional speed-dial entries to this group. When finished, select the **Done Selecting** option, and then press **OK**. Select **Done** at the **Group Name** screen.
  - To delete an entry from a group: Select **Group Speed Dial**, select the group speed-dial entry that you want to change, and then press **OK**. Use the arrow keys to highlight a speed-dial entry, and then press **OK** to select it (the check mark is removed from the speed-dial entry). Repeat this step to remove additional speed-dial entries from this group. When finished, select the **Done Selecting** option, and then press **OK**. Select **Done** at the **Group Name** screen.
  - To delete a group: Select **Delete Speed Dial**, press the arrow keys to highlight the speed-dial entry that you want to delete, and then press **OK**.

## Print and view a list of speed-dial entries

You can print or view a list of all of the speed-dial entries that have been set up. Each entry in the list contains the following information:

- Speed-dial number (the first five entries correspond to the five speed-dial buttons on the control panel)
- Name associated with the fax number or group of fax numbers
- For the fax speed-dial list, the fax number (or all of the fax numbers for a group)

### View a list of speed-dial entries

**HP Photosmart Software:** Open the HP Photosmart Software and follow the instructions in the onscreen Help.

---

# 3 Print

This section contains the following topics:

- [Change print settings](#)
- [Print on both sides \(duplexing\)](#)
- [Cancel a print job](#)

## Change print settings

You can change print settings (such as paper size or type) from an application or the printer driver. Changes made from an application take precedence over changes made from the printer driver. However, after the application is closed, the settings return to the defaults configured in the driver.

---

 **NOTE:** To set print settings for all print jobs, make the changes in the printer driver.

For more information about the features of the Windows printer driver, see the online help for the driver. For more information about printing from a specific application, see the documentation that came with the application.

---

## Change settings from an application for current jobs

### To change the settings

1. Open the document that you want to print.
2. On the **File** menu, click **Print**, and then click **Setup**, **Properties**, or **Preferences**. (Specific options may vary depending on the application that you are using.)
3. Change the settings that you want, and then click **OK**, **Print**, or a similar command.

## Change default settings for all future jobs

### To change the settings

1. Click **Start**, point to **Settings**, and then click **Printers** or **Printers and Faxes**.  
- Or -  
Click **Start**, click **Control Panel**, and then double-click **Printers**.
2. Right-click the printer icon, and then click **Properties**, **Document Defaults**, or **Printing Preferences**.
3. Change the settings that you want, and then click **OK**.

## Print on both sides (duplexing)

You can print on both sides of a sheet of media by manually turning the media over and feeding it into the device again.

- [Guidelines for printing on both sides of a page](#)
- [Perform duplexing](#)

## Guidelines for printing on both sides of a page

- Always use media that conforms to the device specifications. For more information, see [Understand specifications for supported media](#).
- Do not print on both sides of transparencies, envelopes, photo paper, glossy media, or paper lighter than 16 lb bond (60 g/m<sup>2</sup>) or heavier than 28 lb bond (105 g/m<sup>2</sup>). Jams might occur with these media types.
- Several kinds of media require a specific orientation when you print on both sides of a page, such as letterhead, preprinted paper, and paper with watermarks and prepunched holes. The device prints the first side of the media first. Load the media with the front side facing down.

## Perform duplexing

### To print on both sides of a page

1. Load the appropriate media. For more information, see [Guidelines for printing on both sides of a page](#) and [Load media](#).
2. With a document open, click **Print** on the **File** menu, and then click **Setup**, **Properties**, or **Preferences**.
3. Click the **Features** tab.
4. Select the **Two-sided printing** drop-down list.
5. To automatically resize each page to match the document's onscreen layout, ensure **Preserve Layout** is selected. Clearing this option might result in unwanted page breaks.
6. Select or clear the **Flip Pages Up** check box depending on which way you want the binding. See the graphics in the print driver for examples.
7. Choose a booklet layout from the **Booklet Layout** drop-down list, if you want.
8. Change any other settings, and then click **OK**.
9. Print your document.

## Cancel a print job

You can cancel a print job using one of the following methods.

- **Control panel:** Press **X** (**Cancel** button). This clears the job that the device is currently processing. It does not affect jobs waiting to be processed.
- **Windows:** Double-click the printer icon that appears in the lower-right corner of the computer screen. Select the print job, and then press the **Delete** key on the keyboard.

---

# 4 Copy

You can produce high-quality color and grayscale copies on a variety of paper types and sizes.

This section contains the following topics:

- [Make copies from the control panel](#)
- [Change the copy settings](#)
- [Set the number of copies](#)
- [Set the copy paper size](#)
- [Set the copy paper type from the control panel](#)
- [Change copy speed or quality from the control panel](#)
- [Resize an original to fit onto letter or A4 paper](#)
- [Copy a legal-size document onto letter paper](#)
- [Adjust the lightness and darkness of your copy](#)
- [Enhance blurred areas of your copy](#)
- [Enhance light areas of your copy from the control panel](#)
- [Cancel a copy job](#)

## Make copies from the control panel

You can make quality copies from the control panel.

### To make a copy from the control panel

1. Make sure you have paper loaded in the input tray.
2. Load your original using the scanner glass or the ADF. For more information, see [Load originals](#).
3. Do one of the following:
  - Press **START COPY Black** to start a black-and-white copy job.
  - Press **START COPY Color** to start a color copy job.



**NOTE:** If you have a color original, pressing **START COPY Black** produces a black-and-white copy of the color original, while pressing **START COPY Color** produces a full-color copy of the color original.

---

## Change the copy settings

You can customize the copy settings to handle nearly any task.

When you change copy settings, the changes are for the current copy job only. You must set the changes as defaults for the settings to apply to all future copy jobs.

**To save the current settings as defaults for future jobs**

1. Make any necessary changes to the settings in the **Copy Menu**.
2. Press **Copy Menu**, and then press the arrow keys until **Set New Defaults** appears.
3. Press the arrow keys to select **Yes**, and then press **OK**.

## Set the number of copies

You can set the number of copies that you want to print by using the **Number of Copies** option.

**To set the number of copies from the control panel**

1. Make sure you have paper loaded in the input tray.
2. Load your original print side down on the right front corner of the glass or print side up in the document feeder tray.  
If you use the document feeder tray, place the pages so that the top edge of the document goes in first.
3. In the Copy area, press **Copy Menu** repeatedly until **Number of Copies** appears.
4. Press  or use the keypad to enter the number of copies, up to the maximum.

---

 **TIP:** If you hold down either of the arrow buttons, the number of copies changes by increments of 5 to make it easier to set a large number of copies.

---

5. Press **START COPY Black** or **START COPY Color**.

## Set the copy paper size

You can set the paper size on the device. The paper size you select should match what is loaded in your input tray.

**To set the paper size from the control panel**

1. In the Copy area, press **Copy Menu** repeatedly until **Copy Paper Size** appears.
2. Press  until the appropriate paper size appears.
3. Press **START COPY Black** or **START COPY Color**.

## Set the copy paper type from the control panel

You can set the paper type on the device.

**To set the paper type for copies**

1. In the Copy area, press **Copy Menu** repeatedly until **Paper Type** appears.
2. Press  until the appropriate paper type appears.
3. Press **START COPY Black** or **START COPY Color**.

Refer to the following table to determine which paper type setting to choose based on the paper loaded in the input tray.

Paper type	Control panel setting
Copier paper or letterhead	Plain Paper
HP Bright White Paper	Plain Paper
HP Premium Plus Photo Paper, Glossy	Premium Photo
HP Premium Plus Photo Paper, Matte	Premium Photo
HP Premium Plus 10 x 15 cm (4 x 6 inch) Photo Paper	Premium Photo
HP Premium or Premium Plus Inkjet Transparency Film	Transparency
Other transparency film	Transparency

## Change copy speed or quality from the control panel

The device provides three options that affect copy speed and quality:

- **Best** produces the highest quality for all paper and eliminates the banding (striping) effect that sometimes occurs in solid areas. **Best** copies slower than the other quality settings.
- **Normal** delivers high-quality output and is the recommended setting for most of your copying. **Normal** copies faster than **Best** and is the default setting.
- **Fast** copies faster than the **Normal** setting. The text is comparable to the quality of the **Normal** setting, but the graphics might be lower quality. The **Fast** setting uses less ink and extends the life of your print cartridges.

### To change the copy quality

1. Make sure you have paper loaded in the input tray.
2. Load your original print side down on the right front corner of the glass or print side up in the document feeder tray.  
If you use the document feeder tray, place the pages so that the top edge of the document goes in first.
3. In the Copy area, press **Quality** until the appropriate quality setting is lit.
4. Press **START COPY Black** or **START COPY Color**.

## Resize an original to fit onto letter or A4 paper

If the image or text on your original fills the entire sheet with no margins, use **Fit to Page** or **Full Page 91%** to reduce your original and prevent unwanted cropping of the text or images at the edges of the sheet.





---

 **TIP:** You can also use **Fit to Page** to enlarge a small photo to fit within the printable area of a full-size page. In order to do this without changing the proportions of the original or cropping the edges, the device might leave an uneven amount of white space around the edges of the paper.

---

### To resize a document from the control panel

1. Make sure you have paper loaded in the input tray.
2. Load your original print side down on the right front corner of the glass or print side up in the document feeder tray.  
If you use the document feeder tray, place the pages so that the top edge of the document goes in first.
3. In the Copy area, press the **Reduce/Enlarge** button.
4. Do one of the following:
  - If you loaded your original in the document feeder tray or on the glass, press  until **Full Page 91%** appears.
  - If you loaded a full- or small-size original on the glass, press  until **Fit to Page** appears.
5. Press **START COPY Black** or **START COPY Color**.

## Copy a legal-size document onto letter paper

You can use the **Legal > Ltr 72%** setting to reduce a copy of a legal-size document to a size that fits onto letter paper.

---

 **NOTE:** The percentage in the example, **Legal > Ltr 72%**, might not match the percentage that appears in the display.

---

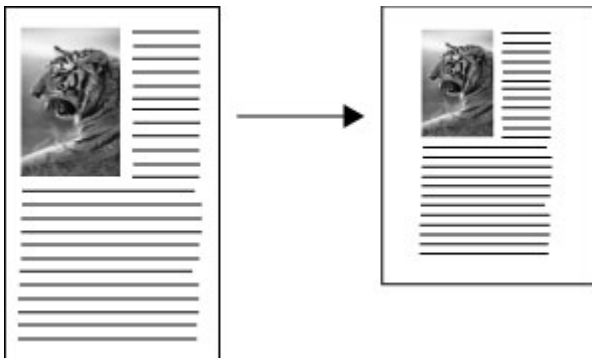

### To copy a legal-size document onto letter paper

1. Make sure you have paper loaded in the input tray.
2. Load your legal-size document print side up in the document feeder tray.  
Place the page in the document feeder tray so that the top edge of the document goes in first.
3. In the Copy area, press the **Reduce / Enlarge** button.
4. Press **▶** until **Legal > Ltr 72%** appears.
5. Press **START COPY Black** or **START COPY Color**.

## Adjust the lightness and darkness of your copy

You can use the **Lighter / Darker** option to adjust the contrast of the copies you make.

### To adjust the copy contrast from the control panel

1. Make sure you have paper loaded in the input tray.
2. Load your original print side down on the right front corner of the glass or print side up in the document feeder tray.  
If you use the document feeder tray, place the pages so that the top edge of the document goes in first.
3. In the Copy area, press **Copy Menu** repeatedly until **Lighter / Darker** appears.
4. Do one of the following:
  - Press **▶** to darken the copy.
  - Press **◀** to lighten the copy.
5. Press **START COPY Black** or **START COPY Color**.

## Enhance blurred areas of your copy

You can use the **Enhancements** feature to adjust the quality of text documents by sharpening edges of black text or adjust photographs by enhancing light colors that might otherwise appear white.

The **Mixed** enhancement is the default option. Use the **Mixed** enhancement to sharpen edges of most originals.



### To copy a blurred document from the control panel

1. Make sure you have paper loaded in the input tray.
2. Position the photo on the glass so the long edge of the photo is along the front edge of the glass.  
Load your original print side down on the right front corner of the glass or print side up in the document feeder tray.
3. In the Copy area, press **Copy Menu** repeatedly until **Enhancements** appears.
4. Press **▶** until the **Text** setting appears.
5. Press **START COPY Black** or **START COPY Color**.

If any of the following occur, turn off **Text** enhancement by selecting **Photo** or **None**:

- Stray dots of color surround some text on your copies
- Large, black typefaces look splotchy (not smooth)
- Thin, colored objects or lines contain black sections
- Horizontal grainy or white bands appear in light- to medium-gray areas

## Enhance light areas of your copy from the control panel

You can use **Photo** enhancements to enhance light colors that might otherwise appear white. You can also use **Photo** enhancements to eliminate or reduce any of the following that might occur when copying with **Text** enhancements:

- Stray dots of color surround some text on your copies
- Large, black typefaces look splotchy (not smooth)
- Thin, colored objects or lines contain black sections
- Horizontal grainy or white bands appear in light- to medium-gray areas

### To copy an overexposed photo

1. Make sure you have paper loaded in the input tray.
2. Load your original photo print side down on the right front corner of the glass.  
Position the photo on the glass so the long edge of the photo is along the front edge of the glass.
3. In the Copy area, press **Copy Menu** repeatedly until **Enhancements** appears.
4. Press **▶** until the **Photo** enhancement setting appears.
5. Press **START COPY Color**.

## Cancel a copy job

- ▲ To stop copying, press **Cancel** on the control panel.

---

# 5 Scan

You can scan originals and send them to a variety of destinations, such as a folder on the network or a program on a computer. You can use the control panel, the HP photo and imaging software, and TWAIN-compliant or WIA-compliant programs on a computer.

This section contains the following topics:

- [Scan an original](#)
- [Scan from a TWAIN-compliant or a WIA-compliant program](#)
- [Edit a scanned original](#)
- [Change scan settings](#)
- [Cancel a scan job](#)

## Scan an original

You can start a scan from a computer or from the control panel.

---

 **NOTE:** You can also use the HP Photosmart Software to scan an image, including panorama images. Using this software, you can edit a scanned image and create special projects using a scanned image. For information about how to scan from the computer, and how to adjust, resize, rotate, crop, and sharpen your scans, see the onscreen HP Photosmart Software Help that came with your software.

---

To use the scan features, your device and computer must be connected and turned on. The printer software must also be installed and running on your computer prior to scanning. To verify that the printer software is running on a computer running Windows, look for the device icon in the system tray at the lower-right side of the screen, near the clock. If a scanner is available, it will launch the HP ScanPro application. If it is not available, a message appears to let you know that a scanner was not found.

---

 **NOTE:** Closing the HP Digital Imaging Monitor icon in your Windows system tray can cause your device to lose some of its scan functionality and result in the **No Connection** error message. If this happens, you can restore full functionality by restarting your computer or by starting the HP Photosmart Software.

---

## Scan an original to a program on a computer

Use the following steps if your device is directly connected to a computer via a USB cable.

When the scan is complete, the program that you have selected opens and displays the document that you have scanned.

### To send a scan to a program on a computer from the HP photo and imaging software

1. At the computer, open the HP photo and imaging software. For more information, see [Use the HP photo and imaging software](#).
2. See the onscreen Help for further instructions.

### To send a scan to a program on a computer from the control panel

1. Load the original on the scanner glass or in the ADF. For more information, see [Load originals](#).
2. Press the **Scan Menu** or **Scan To** button.
3. Press the arrow keys to select the program that you want to use (such as the HP photo and imaging software), and then press **OK**.
4. Press **START SCAN**.

## Scan from a TWAIN-compliant or a WIA-compliant program

The device is TWAIN-compliant and WIA-compliant and works with programs that support TWAIN-compliant and WIA-compliant scanning devices. While you are in a TWAIN-compliant or WIA-compliant program, you can gain access to the scanning feature and scan an image directly into the program.

TWAIN is supported for all Windows operating systems.

WIA is supported only for Windows XP and Vista direct connections.

### Scan from a TWAIN-compliant program

Generally, a software program is TWAIN-compliant if it has a command such as **Acquire**, **File Acquire**, **Scan**, **Import New Object**, **Insert from**, or **Scanner**. If you are unsure whether the program is compliant or you do not know what the command is called, see the software program Help or documentation.

Start the scan from within the TWAIN-compliant program. See the software program Help or documentation for information about the commands and steps to use.

---

 **NOTE:** If you start a TWAIN scan while a fax is being received, an error message will be displayed and the scan is not performed. Wait until the fax has been received and then restart the scan.

---

### Scan from a WIA-compliant program

Generally, a software program is WIA-compliant if it has a command such as **Picture/ From Scanner or Camera** in the **Insert** or **File** menu. If you are unsure whether the program is compliant or you do not know what the command is called, see the software program Help or documentation.

Start the scan from within the WIA-compliant program. See the software program Help or documentation for information about the commands and steps to use.

## Edit a scanned original

You can edit a scanned image using the HP Photosmart Software. You can also edit a scanned document by using your Optical Character Recognition (OCR) software.

## Edit a scanned photo or graphic

You can edit a scanned photo or graphic using the HP Photosmart Software. Use this software to adjust the brightness, contrast, color saturation, and more. You can also rotate the image using the HP Photosmart Software.

For more information, see the onscreen HP Photosmart Software Help.

## Edit a scanned document using optical character recognition (OCR) software

You can use OCR software to import scanned text into your preferred word-processing program for editing. This allows you to edit faxes, letters, newspaper clippings, and many other documents.

You can specify the word-processing program that you want to use for editing. If the word-processing icon is not present or active, either you do not have word-processing software installed on your computer, or the scanner software did not recognize the program during the installation. See the onscreen Help for the HP photo and imaging software for information about how to create a link to the word-processing program.

The OCR software does not support scanning colored text. Colored text is always converted to black-and-white text before being sent to OCR. Thus, all text in the final document is in black and white, regardless of the original color.

Because of the complexity of some word-processing programs and their interaction with the device, it is sometimes preferable to scan to Wordpad (a Windows accessory), and then cut and paste the text into the preferred word-processing program.

## Change scan settings

### To change scan settings

**Windows:** Open the device software, select **Settings**, select **Scan Settings and Preferences**, then select from the available options and make your selections.

## Cancel a scan job

- ▲ Press **Cancel** on the control panel.



**NOTE:** You can also press **Cancel** on the scan progress dialog box to cancel a scan.

---

---

# 6 Fax

You can use the device to send and receive faxes, including color faxes. You can schedule faxes to be sent at a later time and set up speed-dials to send faxes quickly and easily to frequently used numbers. From the control panel, you can also set a number of fax options, such as resolution and the contrast between lightness and darkness on the faxes you send.

If the device is directly connected to a computer, you can use the HP photo and imaging software to perform fax procedures that are not available from the control panel. For more information about using the HP photo and imaging software, see [Use the HP photo and imaging software](#).

---

 **NOTE:** Before you begin faxing, make sure you have set up the device properly for faxing. You might have already done this as part of the initial setup, by using either the control panel or the software that came with the device. You can verify the fax is set up correctly by running the fax setup test from the control panel. To run the fax test, press **Setup**, select **Tools**, select **Run fax test**, and then press **OK**.

---

This section contains the following topics:

- [Send a fax](#)
- [Receive a fax](#)
- [Change fax settings](#)
- [Fax over the Internet](#)
- [Test fax setup](#)
- [Use reports](#)
- [Cancel a fax](#)

## Send a fax

Using the control panel, you can send a black-and-white or color fax.

- [Send a basic fax](#)
- [Send a fax manually from a phone](#)
- [Send a fax using monitor dialing](#)
- [Send a fax from memory](#)
- [Schedule a fax to send later](#)
- [Send a fax to multiple recipients from the control panel](#)
- [Send a color original or photo fax](#)
- [Change the fax resolution and Lighter / Darker settings](#)
- [Send a fax in Error Correction Mode](#)

### Send a basic fax

You can easily send a single- or multiple-page black-and-white fax by using the control panel.

---

 **NOTE:** If you need printed confirmation that your faxes were successfully sent, enable fax confirmation **before** sending any faxes.

 **TIP:** You can also send a fax manually from a phone or by using monitor dialing. These features allow you to control the pace of your dialing. They are also useful when you want to use a calling card to charge the call and you have to respond to tone prompts while dialing.

---

### To send a basic fax from the control panel

1. Load your originals. For additional information, see [Load originals](#).

---

 **NOTE:** If you are sending a multiple-page fax, you must load the originals in the document feeder tray. You cannot fax a multiple-page document from the glass.

2. Enter the fax number by using the keypad, press **Speed Dial** or a one-touch speed dial button to select a speed dial, or press **Redial/Pause** to redial the last number dialed.

---

 **TIP:** To add a pause in the fax number you are entering, press **Redial/Pause**, or press the **Symbols (\*)** button repeatedly, until a dash (-) appears on the display.

3. Press **START FAX Black** or **START FAX Color**.
  - **If the device detects an original loaded in the automatic document feeder**, it sends the document to the number you entered.
  - **If the device does not detect an original loaded in the automatic document feeder**, the **Fax from glass?** prompt appears. Make sure your original is loaded print-side down on the glass, and then select **Yes**.

---

 **TIP:** If the recipient reports issues with the quality of the fax you sent, you can try changing the resolution or contrast of your fax.

---

### Send a fax manually from a phone

You can send a fax from a telephone on the same phone line if you prefer to use the keypad on your phone, instead of the keypad on the control panel of the device. You can do this by plugging in a phone into the 2-EXT port on the back of the device. When you send a fax manually, you can hear the dial tones, telephone prompts, or other sounds through the handset on your telephone. This makes it easy for you to use a calling card to send your fax.

Depending on how the recipient has their fax machine set up, the recipient might answer the phone, or the fax machine might take the call. If a person answers the phone, you can speak with the recipient before sending the fax. If a fax machine answers the call,

you can send the fax directly to the fax machine when you hear the fax tones from the receiving fax machine.

### To send a fax manually from a phone

1. Load your originals. For additional information, see [Load originals](#).

---

 **NOTE:** This feature is not supported if you load your originals on the glass. You must load your originals in the document feeder tray.

---

2. Dial the number by using the keypad on the phone that is connected to the device.

---

 **NOTE:** Do not use the keypad on the control panel of the device when manually sending a fax. You must use the keypad on your phone to dial the recipient's number.

---

3. If the recipient answers the telephone, you can engage in a conversation before sending your fax.

---

 **NOTE:** If a fax machine answers the call, you will hear fax tones from the receiving fax machine. Proceed to the next step to transmit the fax.

---

4. When you are ready to send the fax, press **START FAX Black** or **START FAX Color**.

---

 **NOTE:** If prompted, select **Send Fax**, and then press **START FAX Black** or **START FAX Color** again.

---

If you were speaking with the recipient before sending the fax, inform the recipient that they should press **Start** on their fax machine after they hear fax tones.

The telephone line is silent while the fax is transmitting. At this point, you can hang up the telephone. If you want to continue speaking with the recipient, remain on the line until the fax transmission is complete.

### Send a fax using monitor dialing

Monitor dialing allows you to dial a number from the control panel as you would dial a regular telephone. When you send a fax using monitor dialing, you can hear the dial tones, telephone prompts, or other sounds through the speakers on the device. This enables you to respond to prompts while dialing, as well as control the pace of your dialing.

---

 **TIP:** If you do not enter your calling card PIN fast enough, the device might start sending fax tones too soon and cause your PIN not to be recognized by the calling card service. If this is the case, you can create a speed dial entry to store the PIN for your calling card.

---

 **NOTE:** Make sure the volume is turned on, or you will not hear a dial tone.

---

### To send a fax using monitor dialing from the control panel

1. Load your originals. For additional information, see [Load originals](#).

---

 **NOTE:** If you are sending a multiple-page fax, you must load the originals print-side up in the document feeder tray. You cannot fax a multiple-page document from the glass. For additional information, see [Load originals](#).

---

2. Press **START FAX Black** or **START FAX Color**.
  - **If the device detects an original loaded in the automatic document feeder**, you will hear a dial tone.
  - **If the device does not detect an original loaded in the automatic document feeder**, the **Fax from glass?** prompt appears. Make sure that your original is loaded on the glass, and then select **Yes**.
3. When you hear the dial tone, enter the number by using the keypad on the control panel.
4. Follow any prompts that might occur.

---

 **TIP:** If you are using a calling card to send a fax and you have your calling card PIN stored as a speed dial, when prompted to enter your PIN, press **Speed Dial** or a one-touch speed dial button to select the speed dial entry where you have your PIN stored.

---

Your fax is sent when the receiving fax machine answers.

### Send a fax from memory

You can scan a black-and-white fax into memory and then send the fax from memory. This feature is useful if the fax number you are trying to reach is busy or temporarily unavailable. The device scans the originals into memory and sends them once it is able to connect to the receiving fax machine. After the device scans the pages into memory, you can immediately remove the originals from the document feeder tray.

---

 **NOTE:** You cannot send a color fax from memory due to memory limitations.

---

### To send a fax from memory

1. Load your originals print side up into the document feeder tray.

---

 **NOTE:** This feature is not supported if you load your originals on the glass. You must load your originals in the document feeder tray.

---

2. In the Fax area, press **Fax Menu**.  
The **Enter Number** prompt appears.
3. Enter the fax number by using the keypad, press **Speed Dial** or a one-touch speed dial button to select a speed dial, or press **Redial/Pause** to redial the last number dialed.
4. In the Fax area, press **Fax Menu** repeatedly until **How to Fax** appears.



5. Press **▶** until **Scan & Fax** appears, and then press **OK**.
6. Press **START FAX Black**.

---

 **NOTE:** If you press **START FAX Color**, the fax will be sent in black and white and a message appears on the display.

---

The device scans the originals into memory and sends the fax when the receiving fax machine is available.

### Schedule a fax to send later

You can schedule a black-and-white fax to be sent within the next 24 hours. This enables you to send a black-and-white fax late in the evening, when phone lines are not as busy or phone rates are lower, for example. When scheduling a fax, the originals must be loaded in the document feeder tray and not on the glass. The device automatically sends your fax at the specified time.

You can only schedule one fax to be sent at a time. You can continue to send faxes normally, however, while a fax is scheduled.

---

 **NOTE:** You cannot schedule a color fax due to memory limitations.

---

#### To schedule a fax from the control panel

1. Load your originals print side up into the document feeder tray.

---

 **NOTE:** Load your originals in the document feeder tray, and not on the glass. This feature is not supported if you load your originals on the glass.

---

2. In the Fax area, press **Fax Menu** repeatedly until **How to Fax** appears.
3. Press **▶** until **Send Fax Later** appears, and then press **OK**.
4. Enter the send time by using the numeric keypad, and then press **OK**. If prompted, press **1** for **AM**, or **2** for **PM**.
5. Enter the fax number by using the keypad, press **Speed Dial** or a one-touch speed dial button to select a speed dial, or press **Redial/Pause** to redial the last number dialed.
6. Press **START FAX Black**.

The device scans all pages and the scheduled time appears on the display. The fax is sent at the scheduled time.

#### To cancel a scheduled fax

1. In the Fax area, press **Fax Menu** repeatedly until **How to Fax** appears.
2. Press **▶** until **Send Fax Later** appears, and then press **OK**.  
If there is a fax already scheduled, the **Cancel** prompt appears on the display.
3. Press **1** to select **Yes**.

---

 **NOTE:** You can also cancel the scheduled fax by pressing **Cancel** on the control panel when the scheduled time is visible on the display.

---

### Send a fax to multiple recipients from the control panel

You can send a fax to multiple recipients without first setting up a group speed dial.

---

 **NOTE:** The list of recipients you specify for this fax is not saved and only works for sending faxes in black. If you intend to send other faxes to the same recipient list, you should create a group speed dial list. For more information, see [Set up fax numbers as speed-dial entries or groups](#).

---

### To send a fax to multiple recipients without using group speed dial

1. Press **Fax Menu** and select **Broadcast Fax**.
2. Enter a fax number by using the keypad, or use the arrow keys to access speed dials.

 **NOTE:** You can add up to 20 individual fax numbers.

---

3. Press **START FAX Black**.
4. When prompted, load your originals print side up and top first in the center of the document feeder tray. For additional information, see [Load originals](#).
5. Press **START FAX Black** again.

You can send a fax to multiple recipients at once by grouping individual speed dial entries into group speed dial entries.



### To send a fax to multiple recipients using group speed dial

1. Load your originals print side up into the document feeder tray. If you are sending a single-page fax, such as a photograph, you can also load your original print side down on the glass.

 **NOTE:** If you are sending a multiple-page fax, you must load the originals in the document feeder tray. You cannot fax a multiple-page document from the glass.

---

2. Press **Speed Dial** repeatedly, until the appropriate group speed dial entry appears.

 **TIP:** You can also scroll through the speed dial entries by pressing  or , or you can select a speed dial entry by entering its speed dial code using the keypad on the control panel.

---

3. Press **START FAX Black**.
  - **If the device detects an original loaded in the automatic document feeder**, it sends the document to each number in the group speed dial entry.
  - **If the device does not detect an original loaded in the automatic document feeder**, the **Fax from glass?** prompt appears. Make sure your original is loaded on the glass, and then press **1** to select **Yes**.

 **NOTE:** You can only use group speed dial entries to send faxes in black and white, because of memory limitations. The device scans the fax into memory then dials the first number. When a connection is made, it sends the fax and dials the next number. If a number is busy or not answering, the device follows the settings for **Busy Redial** and **No Answer Redial**. If a connection cannot be made, the next number is dialed and an error report is generated.

---

## Related topics

- [Set up speed-dial entries](#)
- [Print fax confirmation reports](#)

## Send a color original or photo fax

You can fax a color original or photo from the device. If it determines that the recipient's fax machine only supports black-and-white faxes, the fax is sent in black and white.

HP recommends that you use only color originals for color faxing.

### To send a color original or photo fax from the control panel

1. Load your originals print side up into the document feeder tray. If you are sending a single-page fax, such as a photograph, you can also load your original print side down on the glass.

---

 **NOTE:** If you are sending a multiple-page fax, you must load the originals in the document feeder tray. You cannot fax a multiple-page document from the glass.

 **TIP:** To center a 10 x 15 cm (4 x 6 inch) photo, place the photo on the center of a blank letter- or A4-size sheet of paper, and then place the original on the glass.

---

2. In the Fax area, press **Fax Menu**.  
The **Enter Number** prompt appears.
3. Enter the fax number by using the keypad, press **Speed Dial** or a one-touch speed dial button to select a speed dial, or press **Redial/Pause** to redial the last number dialed.
4. Press **START FAX Color**.
  - **If the device detects an original loaded in the automatic document feeder**, it sends the document to the number you entered.
  - **If the device does not detect an original loaded in the automatic document feeder**, the **Fax from glass?** prompt appears. Make sure your original is loaded on the glass, and then press **1** to select **Yes**.

---

 **NOTE:** If the recipient's fax machine only supports black-and-white faxes, the device automatically sends the fax in black and white. A message appears after the fax has been sent indicating that the fax was sent in black and white. Press **OK** to clear the message.

---

## Change the fax resolution and Lighter / Darker settings

You can change the **Resolution** and **Lighter / Darker** settings for documents that you are faxing.

---

 **NOTE:** These settings do not affect copy settings. Copy resolution and lightness/darkness are set independently from fax resolution and lightness/darkness. Also, the settings that you change from the control panel do not affect faxes you send from your computer.

---

This section contains the following topics:

- [Change the fax resolution](#)
- [Change the Lighter / Darker setting](#)
- [Set new default settings](#)

### Change the fax resolution

The **Resolution** setting affects the transmission speed and quality of faxed black-and-white documents. If the receiving fax machine does not support the resolution you have chosen, the device sends faxes at the highest resolution supported by the receiving fax machine.

---

 **NOTE:** You can only change the resolution for faxes that you are sending in black and white. The device sends all color faxes using **Fine** resolution.

---

The following resolution settings are available for sending faxes: **Fine**, **Very Fine**, **Photo**, and **Standard**.

- **Fine:** provides high-quality text suitable for faxing most documents. This is the default setting. When sending faxes in color, the device always uses the **Fine** setting.
- **Very Fine:** provides the best quality fax when you are faxing documents with very fine detail. If you choose **Very Fine**, be aware that the faxing process takes longer to complete and you can only send black-and-white faxes using this resolution. If you send a color fax, it will be sent using **Fine** resolution instead.
- **Photo:** provides the best quality fax when sending photographs in black and white. If you choose **Photo**, be aware that the faxing process takes longer to complete. When faxing photographs in black and white, HP recommends that you choose **Photo**.
- **Standard:** provides the fastest possible fax transmission with the lowest quality.

When you exit the Fax menu, this option returns to the default setting unless you set your changes as the default.

### To change the resolution from the control panel

1. Load your originals print side up into the document feeder tray. If you are sending a single-page fax, such as a photograph, you can also load your original print side down on the glass.

---

 **NOTE:** If you are sending a multiple-page fax, you must load the originals in the document feeder tray. You cannot fax a multiple-page document from the glass.

---

2. In the Fax area, press **Fax Menu**.  
The **Enter Number** prompt appears.
3. Enter the fax number by using the keypad, press **Speed Dial** or a one-touch speed dial button to select a speed dial, or press **Redial/Pause** to redial the last number dialed.
4. In the Fax area, press **Fax Menu** repeatedly until **Resolution** appears.

5. Press **▶** to select a resolution setting, and then press **OK**.
6. Press **START FAX Black**.
  - **If the device detects an original loaded in the automatic document feeder**, it sends the document to the number you entered.
  - **If the device does not detect an original loaded in the automatic document feeder**, the **Fax from glass?** prompt appears. Make sure your original is loaded on the glass, and then press **1** to select **Yes**.

### Related topics

[Set new default settings](#)

### Change the Lighter / Darker setting

You can change the contrast of a fax to be darker or lighter than the original. This feature is useful if you are faxing a document that is faded, washed out, or handwritten. You can darken the original by adjusting the contrast.

---

 **NOTE:** The **Lighter / Darker** setting applies to black and white faxes only, not color faxes.

---

When you exit the Fax menu, this option returns to the default setting unless you set your changes as the default.

### To change the Lighter / Darker setting from the control panel

1. Load your originals print side up into the document feeder tray. If you are sending a single-page fax, such as a photograph, you can also load your original print side down on the glass.

---

 **NOTE:** If you are sending a multiple-page fax, you must load the originals in the document feeder tray. You cannot fax a multiple-page document from the glass.

---

2. In the Fax area, press **Fax Menu**.  
The **Enter Number** prompt appears.
3. Enter the fax number by using the keypad, press **Speed Dial** or a one-touch speed dial button to select a speed dial, or press **Redial/Pause** to redial the last number dialed.
4. In the Fax area, press **Fax Menu** repeatedly until **Lighter / Darker** appears.
5. Press **◀** to lighten the fax or press **▶** to darken it, and then press **OK**.  
The indicator moves to the left or right as you press an arrow button.
6. Press **START FAX Black**.
  - **If the device detects an original loaded in the automatic document feeder**, it sends the document to the number you entered.
  - **If the device does not detect an original loaded in the automatic document feeder**, the **Fax from glass?** prompt appears. Make sure your original is loaded on the glass, and then press **1** to select **Yes**.

### Related topics

[Set new default settings](#)

### Set new default settings

You can change the default value for the **Resolution** and **Lighter / Darker** settings through the control panel.

#### To set new default settings from the control panel

1. Make changes to the **Resolution** and **Lighter / Darker** settings.
2. In the Fax area, press **Fax Menu** repeatedly until **Set New Defaults** appears.
3. Press **▶** until **Yes** appears, and then press **OK**.

### Send a fax in Error Correction Mode

**Error Correction Mode (ECM)** prevents loss of data due to poor phone lines by detecting errors that occur during transmission and automatically requesting retransmission of the erroneous portion. Phone charges are unaffected, or might even be reduced, on good phone lines. On poor phone lines, ECM increases sending time and phone charges, but sends the data much more reliably. The default setting is **On**. Turn ECM off only if it increases phone charges substantially, and you can accept poorer quality in exchange for reduced charges.

Before turning the ECM setting off, consider the following. If you turn ECM off:

- The quality and transmission speed of faxes you send and receive are affected.
- The **Fax Speed** is automatically set to **Medium**.
- You will no longer be able to send or receive faxes in color.

#### To change the ECM setting from the control panel

1. Press **Setup**.
2. Press **5**, and then press **6**.  
This selects **Advanced Fax Setup** and then selects **Error Correction Mode**.
3. Press **▶** to select **On** or **Off**.
4. Press **OK**.

## Receive a fax

You can receive faxes automatically or manually. If you turn off the **Auto Answer** option, you must receive faxes manually. If you turn on the **Auto Answer** option (the default setting), the device automatically answers incoming calls and receives faxes after the number of rings that are specified by the **Rings to Answer** setting. (The default **Rings to Answer** setting is five rings.)

If you receive a legal-size fax and the device is not currently set to use legal-size paper, the device reduces the fax so that it fits on the paper that is loaded. If you have disabled the **Automatic Reduction** feature, the device prints the fax on two pages.

- [Receive a fax manually](#)
- [Set up backup fax reception](#)
- [Reprint received faxes from memory](#)
- [Poll to receive a fax](#)
- [Forward faxes to another number](#)

- [Set the paper size for received faxes](#)
- [Set automatic reduction for incoming faxes](#)
- [Block junk fax numbers](#)

## Receive a fax manually

When you are on the phone, the person you are speaking with can send you a fax while you are still connected. This is referred to as manual faxing. Use the instructions in this section to receive a manual fax.

You can receive faxes manually from a phone that is:

- Directly connected to the device (on the 2-EXT port)
- On the same phone line, but not directly connected to the device

### To receive a fax manually

1. Make sure the device is turned on and you have paper loaded in the input tray.
2. Remove any originals from the document feeder tray.
3. Set the **Rings to Answer** setting to a high number to allow you to answer the incoming call before the device answers. Or, turn off the **Auto Answer** setting so that the device does not automatically answer incoming calls.
4. If you are currently on the phone with the sender, instruct the sender to press **Start** on their fax machine.
5. When you hear fax tones from a sending fax machine, do the following:
  - a. Press **START FAX Black** or **START FAX Color** on the control panel.
  - b. When prompted, select **Fax Receive**.
  - c. After the device begins to receive the fax, you can hang up the phone or remain on the line. The phone line is silent during fax transmission.

## Set up backup fax reception

Depending on your preference and security requirements, you can set up the device to store all the faxes it receives, only the faxes it receives while the device is in an error condition, or none of the faxes it receives.

The following **Backup Fax Reception** modes are available:

<b>On</b>	<p>The default setting. When <b>Backup Fax Reception</b> is <b>On</b>, the device stores all received faxes in memory. This enables you to reprint up to eight of the most recently printed faxes if they are still saved in memory.</p> <hr/> <p><b>NOTE:</b> When device memory is low, it overwrites the oldest, printed faxes as it receives new faxes. If the memory becomes full of unprinted faxes, the device stops answering incoming fax calls.</p> <hr/> <p><b>NOTE:</b> If you receive a fax that is too large, such as a very detailed color photo, it might not be stored in memory due to memory limitations.</p> <hr/>
<b>On Error Only</b>	<p>Causes the device to store faxes in memory only if an error condition exists that prevents the device from printing the faxes (for example, if the device runs out of paper). The device continues to store incoming faxes as long as there is memory available. (If the memory becomes full, the device stops answering incoming fax calls.) When the error condition is resolved, the</p>

(continued)

	faxes stored in memory print automatically, and then they are deleted from memory.
<b>Off</b>	Faxes are never stored in memory. For example, you might want to turn off <b>Backup Fax Reception</b> for security purposes. If an error condition occurs that prevents the device from printing (for example, the device runs out of paper), the device stops answering incoming fax calls.

 **NOTE:** If **Backup Fax Reception** is enabled and you turn off the device, all faxes stored in memory are deleted, including any unprinted faxes that you might have received while the device was in an error condition. You must contact the senders to ask them to resend any unprinted faxes. For a list of the faxes you have received, print the **Fax Log**. The **Fax Log** is not deleted when the device is turned off.

### To set backup fax reception from the control panel

1. Press **Setup**.
2. Select **Advance Fax Setup**, and then select **Backup Fax Reception**.
3. Press the right arrow button to select **On**, **On Error Only**, or **Off**.
4. Press **OK**.

### Reprint received faxes from memory

If you set the **Backup Fax Reception** mode to **On**, the received faxes are stored in memory, whether the device has an error condition or not.

 **NOTE:** After the memory becomes full, the oldest, printed faxes are overwritten as new faxes are received. If all the stored faxes are unprinted, the device does not receive any fax calls until you print or delete the faxes from memory. You might also want to delete the faxes in memory for security or privacy purposes.

Depending on the sizes of the faxes in memory, you can reprint up to eight of the most recently printed faxes, if they are still in memory. For example, you might need to reprint your faxes if you lost the copy of your last printout.

### To reprint faxes in memory from the control panel

1. Make sure you have paper loaded in the input tray.
2. Press **Setup**.
3. Select **Tools**, and then select **Reprint Faxes in Memory**.  
The faxes are printed in the reverse order from which they were received with the most recently received fax printed first, and so on.
4. If you want to stop reprinting the faxes in memory, press **Cancel**.

### To delete all the faxes in memory from the control panel

- ▲ Turn off the device by pressing the **Power** button.  
All faxes stored in memory are deleted from memory when you turn off the power.

### Poll to receive a fax

Polling allows the HP All-in-One to ask another fax machine to send a fax that it has in its queue. When you use the **Poll to Receive** feature, the HP All-in-One calls the



designated fax machine and requests the fax from it. The designated fax machine must be set for polling and have a fax ready to send.

---

 **NOTE:** The HP All-in-One does not support polling pass codes. Polling pass codes are a security feature that require the receiving fax machine to provide a pass code to the device it is polling in order to receive the fax. Make sure the device you are polling does not have a pass code set up (or has not changed the default pass code) or the HP All-in-One will not be able to receive the fax.

---

#### To set up poll to receive a fax from the control panel

1. In the Fax area, press **Fax Menu** repeatedly until **How to Fax** appears.
2. Press  until **Poll to Receive** appears, and then press **OK**.
3. Enter the fax number of the other fax machine.
4. Press **START FAX Black** or **START FAX Color**.

---

 **NOTE:** If you press **START FAX Color** but the sender sent the fax in black and white, the device prints the fax in black and white.

---

### Forward faxes to another number

You can set up the device to forward your faxes to another fax number. A received color fax is forwarded in black and white.

HP recommends that you verify the number you are forwarding to is a working fax line. Send a test fax to make sure the fax machine is able to receive your forwarded faxes.

#### To forward faxes from the control panel

1. Press **Setup**.
2. Select **Advance Fax Setup**, and then select **Fax Forwarding Black Only**.
3. Press the right arrow button until **On-Forward** or **On-Print & Forward** appears, and then press **OK**.
  - Choose **On-Forward** if you want to forward the fax to another number without printing a backup copy on the device.

---

 **NOTE:** If the device is not able to forward the fax to the designated fax machine (for example, if it is not turned on), the device prints the fax. If you set up the device to print error reports for received faxes, it will also print an error report.

---

- Choose **On-Print & Forward** to print a backup copy of your received fax while forwarding the fax to another number.
4. At the prompt, enter the number of the fax machine that will receive the forwarded faxes.

5. At the prompt, enter a start time and date and a stop time and date.
6. Press **OK**.

**Fax Forwarding** appears on the control-panel display.

If the device loses power when **Fax Forwarding** is set up, it saves the **Fax Forwarding** setting and phone number. When power is restored to the device, the **Fax Forwarding** setting is still **On**.

---

 **NOTE:** You can cancel fax forwarding by pressing **Cancel** on the control panel when the **Fax Forwarding** message is visible on the display, or you can select **Off** from the **Fax Forwarding Black Only** menu.

---

## Set the paper size for received faxes

You can select the paper size for received faxes. The paper size you select should match what is loaded in your input tray. Faxes can be printed on letter, A4, or legal paper only.

---

 **NOTE:** If an incorrect paper size is loaded in the input tray when you receive a fax, the fax does not print and an error message appears on the display. Load letter, A4, or legal paper, and then press **OK** to print the fax.

---

### To set the paper size for received faxes from the control panel

1. Press **Setup**.
2. Press **4**, and then press **4**.  
This selects **Basic Fax Setup** and then selects **Fax Paper Size**.
3. Press  to select an option, and then press **OK**.

## Set automatic reduction for incoming faxes

The **Automatic Reduction** setting determines what the device does if it receives a fax that is too large for the default paper size. This setting is turned on by default, so the image of the incoming fax is reduced to fit on one page, if possible. If this feature is turned off, information that does not fit on the first page is printed on a second page. **Automatic Reduction** is useful when you receive a legal-size fax and letter-size paper is loaded in the input tray.

### To set automatic reduction from the control panel

1. Press **Setup**.
2. Press **5**, and then press **4**.  
This selects **Advanced Fax Setup** and then selects **Automatic Reduction**.
3. Press  to select **Off** or **On**.
4. Press **OK**.

## Block junk fax numbers

If you subscribe to a caller ID service through your phone provider, you can block specific fax numbers so the device does not print faxes received from those numbers. When an incoming fax call is received, the device compares the number to the list of junk fax numbers to determine if the call should be blocked. If the number matches a number in the blocked fax numbers list, the fax is not printed. (The maximum number of fax numbers you can block varies by model.)



---

**NOTE:** This feature is not supported in all countries/regions. If it is not supported in your country/region, **Junk Fax Blocker Set Up** does not appear in the **Basic Fax Setup** menu.

**NOTE:** If no phone numbers are added in the Caller ID list, it is assumed that the user has not signed up for the Caller ID service with the phone company.

---

### Set the junk fax mode

By default, **Block Junk Fax** mode is turned **On**. If you do not subscribe to a caller ID service through your phone provider, or do not want to use this feature, you can turn off this setting.

#### To set the junk fax mode

- ▲ Press the **Junk Fax Blocker** button, select the **Block Junk Fax** option, and then select **On** or **Off**.

#### Add numbers to the junk fax list

There are two ways to add a number to your junk list. You can select numbers from your caller ID history, or you can enter new numbers. The numbers in your junk list are blocked if **Block Junk Fax** mode is set to **On**.

#### To select a number from the caller ID list

1. Press **Setup**.
2. Press **Basic Fax Setup**, and then press **Junk Fax Blocker Setup**.
3. Press **Add number to Junk List**, and then press **Select Number**.
4. Press the right arrow button to scroll through the numbers from which you have received faxes. When the number you want to block appears, press **OK** to select it.
5. When the **Select Another?** prompt appears, do one of the following:
  - **If you want to add another number to the list of junk fax numbers**, press **Yes**, and then repeat step 4 for each number you want to block.
  - **If you are done**, press **No**.

#### To manually enter a number to block

1. Press **Setup**.
2. Press **Basic Fax Setup**, and then press **Junk Fax Blocker Setup**.
3. Press **Add number to Junk List**, and then press **Enter Number**.
4. Use the keypad to enter a fax number to block, and then press **OK**.  
Make sure you enter the fax number as it appears on the control-panel display, and not the fax number that appears on the fax header of the received fax, as these numbers can be different.
5. When the **Enter Another?** prompt appears, do one of the following:
  - **If you want to add another number to the list of junk fax numbers**, press **Yes**, and then repeat step 4 for each number you want to block.
  - **If you are done**, press **No**.

### Remove numbers from the junk fax list

If you no longer want to block a fax number, you can remove a number from your junk fax list.

#### To remove numbers from the list of junk fax numbers

1. Press **Setup**.
2. Press **Basic Fax Setup**, and then press **Junk Fax Blocker Setup**.
3. Press **Remove Number from Junk List**.
4. Press the right arrow button to scroll through the numbers you have blocked. When the number you want to remove appears, press **OK** to select it.
5. When the **Delete Another?** prompt appears, do one of the following:
  - **If you want to remove another number from the list of junk fax numbers**, press **Yes**, and then repeat step 4 for each number you want to block.
  - **If you are done**, press **No**.

## Change fax settings

After completing the steps in the getting started guide that came with the device, use the following steps to change the initial settings or to configure other options for faxing.

- [Configure the fax header](#)
- [Set the answer mode \(Auto answer\)](#)
- [Set the number of rings before answering](#)
- [Change the answer ring pattern for distinctive ring](#)
- [Set the fax error correction mode](#)
- [Set the dial type](#)
- [Set the redial options](#)
- [Set the fax speed](#)

### Configure the fax header

The fax header prints your name and fax number on the top of every fax you send. HP recommends that you set up the fax header by using the software that you installed with the device. You can also set up the fax header from the control panel, as described here.



---

**NOTE:** In some countries/regions, the fax header information is a legal requirement.

---

#### To set or change the fax header

1. Press **Setup**.
2. Press **Basic Fax Setup**, and then press **Fax Header**.
3. Enter your personal or company name using the numeric keypad, and then press **OK**.
4. Enter your fax number by using the numeric keypad, and then press **OK**.

## Set the answer mode (Auto answer)

The answer mode determines whether the device answers incoming calls.

- Turn on the **Auto Answer** setting if you want the device to answer faxes **automatically**. The device answers all incoming calls and faxes.
- Turn off the **Auto Answer** setting if you want to receive faxes **manually**. You must be available to respond in person to the incoming fax call or the device does not receive faxes.

### To set the answer mode to manual or automatic via the control panel

- ▲ Press **Auto Answer** to turn the light on or off, as appropriate for your setup. When the **Auto Answer** light is on, the device answers calls automatically. When the light is off, it does not answer calls.

## Set the number of rings before answering

If you turn on the **Auto Answer** setting, you can specify how many rings occur before incoming calls are automatically answered.

The **Rings to Answer** setting is important if you have an answering machine on the same phone line as the device, because you want the answering machine to answer the phone before the device does. The number of rings to answer for the device should be greater than the number of rings to answer for the answering machine.

For example, set your answering machine to a low number of rings and the device to answer in the maximum number of rings. (The maximum number of rings varies by country/region.) In this setup, the answering machine answers the call and the device monitors the line. If the device detects fax tones, it receives the fax. If the call is a voice call, the answering machine records the incoming message.

### To set the number of rings before answering via the control panel

1. Press **Setup**.
2. Press **Basic Fax Setup**, and then press **Rings to Answer**.
3. Enter the appropriate number of rings by using the keypad, or press the left or right arrow button to change the number of rings.
4. Press **OK** to accept the setting.

## Change the answer ring pattern for distinctive ring

Many phone companies offer a distinctive ring feature that allows you to have several phone numbers on one phone line. When you subscribe to this service, each number is assigned a different ring pattern. You can set up the device to answer incoming calls that have a specific ring pattern.

If you connect the device to a line with distinctive ring, have your telephone company assign one ring pattern to voice calls and another ring pattern to fax calls. HP recommends that you request double or triple rings for a fax number. When the device detects the specified ring pattern, it answers the call and receives the fax.

If you do not have a distinctive ring service, use the default ring pattern, which is **All Rings**.

#### To change the answer ring pattern for distinctive ring via the control panel

1. Verify that the device is set to answer fax calls automatically.
2. Press **Setup**.
3. Press **Advance Fax Setup**, and then press **Distinctive Ring**.
4. Press the right arrow button to select an option, and then press **OK**.  
When the phone rings with the ring pattern assigned to your fax line, the device answers the call and receives the fax.

#### Set the fax error correction mode

Typically, the device monitors the signals on the phone line while it is sending or receiving a fax. If it detects an error signal during the transmission and the error-correction setting is on, the device can request that a portion of the fax be resent.

Turn off error correction only if you are having trouble sending or receiving a fax, and you want to accept the errors in the transmission. Turning off the setting might be useful when you are trying to send a fax to another country/region or receive a fax from another country/region, or if you are using a satellite phone connection.

#### To set the fax error-correction mode

- ▲ **Control panel:** Press **Fax Menu**, open the **Advance Fax Setup** menu, and then use the **Error correction mode** option.

#### Set the dial type

Use this procedure to set tone-dialing or pulse-dialing mode. The factory-set default is **Tone**. Do not change the setting unless you know that your phone line cannot use tone dialing.

---

 **NOTE:** The pulse-dialing option is not available in all countries/regions.

---

#### To set the dial type

- ▲ **Control panel:** Press **Setup**, press **Basic Fax Setup**, and then use the **Tone or Pulse Dialing** option.

#### Set the redial options

If the device was unable to send a fax because the receiving fax machine did not answer or was busy, the device attempts to redial based on the settings for the busy-redial and no-answer-redial options. Use the following procedure to turn the options on or off.

- **Busy redial:** If this option is turned on, the device redials automatically if it receives a busy signal. The factory-set default for this option is **ON**.
- **No answer redial:** If this option is turned on, the device redials automatically if the receiving fax machine does not answer. The factory-set default for this option is **OFF**.

### To set the redial options

- ▲ **Control panel:** Press **Setup**, press **Advance Fax Setup**, and then use the **Busy Redial** or **No Answer Redial** options.

### Set the fax speed

You can set the fax speed used to communicate between your device and other fax machines when sending and receiving faxes. The default fax speed is **Fast**.

If you use one of the following, setting the fax speed to a slower speed might be required:

- An Internet phone service
- A PBX system
- Fax over Internet Protocol (FoIP)
- An integrated services digital network (ISDN) service

If you experience problems sending and receiving faxes, you might want to try setting the **Fax Speed** setting to **Medium** or **Slow**. The following table provides the available fax speed settings.

Fax speed setting	Fax speed
Fast	v.34 (33600 baud)
Medium	v.17 (14400 baud)
Slow	v.29 (9600 baud)

### To set the fax speed from the control panel

1. Press **Setup**.
2. Select **Advanced Fax Setup**, and then press **Fax Speed**.
3. Select an option using the arrow keys, and then press **OK**.

## Fax over the Internet

You may subscribe to a low cost phone service that allows you to send and receive faxes with your device by using the Internet. This method is called Fax over Internet Protocol (FoIP). You probably use a FoIP service (provided by your telephone company) if you:

- Dial a special access code along with the fax number, or
- Have an IP converter box that connects to the Internet and provides analog phone ports for the fax connection.

---

 **NOTE:** You can only send and receive faxes by connecting a phone cord to the port labeled "1-LINE" on the device. This means that your connection to the Internet must be done either through a converter box (which supplies regular analog phone jacks for fax connections) or your telephone company.

---

Some Internet faxing services do not work properly when the device is sending and receiving faxes at high speed (33,600 bps). If you experience problems sending and receiving faxes while using an Internet fax service, use a slower fax speed. You can do this by changing the **Fax Speed** setting from **High** (the default) to **Medium**. For information on changing this setting, see [Set the fax speed](#).

If you have further questions about internet faxing, talk to your Internet service provider

## Test fax setup

You can test your fax setup to check the status of the device and to make sure it is set up properly for faxing. Perform this test after you have completed setting up the device for faxing. The test does the following:

- Tests the fax hardware
- Verifies the correct type of phone cord is connected to the device
- Checks that the phone cord is plugged into the correct port
- Checks for a dial tone
- Checks for an active phone line
- Tests the status of your phone line connection

The device prints a report with the results of the test. If the test fails, review the report for information on how to fix the problem and rerun the test.

### To test fax setup

1. Set up the device for faxing according to your particular home or office setup instructions.
2. Make sure the print cartridges are installed, and that full-size paper is loaded in the input tray before starting the test.
3. From the control panel, press **Setup**.
4. Select **Tools**, and then select **Run Fax Test**.  
The device displays the status of the test on the display and prints a report.
5. Review the report.
  - If the test passes and you are still having problems faxing, check the fax settings listed in the report to verify the settings are correct. A blank or incorrect fax setting can cause problems faxing.
  - If the test fails, review the report for more information on how to fix any problems found.

## Use reports

You can set up the device to print error reports and confirmation reports automatically for each fax you send and receive. You can also manually print system reports as required; these reports provide useful system information about the device.

By default, the device is set to print a report only if there is a problem sending or receiving a fax. A confirmation message that indicates whether a fax was successfully sent appears briefly on the control-panel display after each transaction.

- [Print fax confirmation reports](#)
- [Print fax error reports](#)
- [Print and view the fax log](#)



## Print fax confirmation reports

If you require printed confirmation that your faxes were successfully sent, follow these instructions to enable fax confirmation **before** sending any faxes. Select either **On Fax Send** or **Send & Receive**.

The default fax confirmation setting is **Off**. This means that a confirmation report is not printed for each fax sent or received. A confirmation message indicating whether a fax was successfully sent appears briefly on the control-panel display after each transaction.

### To enable fax confirmation

1. Press **Setup**.
2. Press **Print Report**, and then **Fax Confirmation**.
3. Press the right arrow button to select one of the following, and then press **OK**.

<b>Off</b>	Does not print a fax confirmation report when you send and receive faxes successfully. This is the default setting.
<b>On Fax Send</b>	Prints a fax confirmation report for every fax you send.
<b>On Fax Receive</b>	Prints a fax confirmation report for every fax you receive.
<b>Send &amp; Receive</b>	Prints a fax confirmation report for every fax you send and receive.

 **TIP:** If you choose **On Fax Send** or **Send & Receive**, and scan your fax to send from memory, you can include an image of the first page of the fax on the **Fax Sent Confirmation** report. Press **Setup**, press **Fax Confirmation**, and then press **On Fax Send** again. Select **On** from the **Image on Fax Send Report** menu.

## Print fax error reports

You can configure the device so that it automatically prints a report when there is an error during transmission or reception.

### To set the device to print fax error reports automatically

1. Press **Setup**.
2. Press **Print Report**, and then press **Fax Error Report**.
3. Press the right arrow button to select one of the following, and then press **OK**.

<b>Send &amp; Receive</b>	Prints whenever a fax error occurs. This is the default setting.
<b>Off</b>	Does not print any fax error reports.
<b>On Fax Send</b>	Prints whenever a transmission error occurs.
<b>On Fax Receive</b>	Prints whenever a receiving error occurs.

## Print and view the fax log

The logs list faxes that have been sent from the control panel and all faxes that have been received.

You can print a log of faxes that have been received and sent by the device. Each entry in the log contains the following information:

- Transmission date and time
- Type (whether received or sent)
- Fax number
- Duration
- Number of pages
- Result (status) of transmission

#### **To view the fax log from the HP photo and imaging software**

1. At the computer, open the HP photo and imaging software. For more information, see [Use the HP photo and imaging software](#).
2. See the onscreen Help for the HP photo and imaging software for further instructions. The log lists faxes that have been sent from the control panel and the HP photo and imaging software and all faxes that have been received.

#### **To print the fax log from the control panel**

1. On the control panel, press **Setup**.
2. Press the arrow key to move down to **Print Report**, and then press **OK**.
3. Press the arrow key to move down to **Fax Log**, and then press **OK**.
4. Press **OK** again to print the log.

## **Cancel a fax**

You can cancel a fax you are sending or receiving at any time.

#### **To cancel a fax**

- ▲ Press **Cancel** on the control panel to stop a fax you are sending or receiving. If the device does not stop faxing, press **Cancel** again. The device prints any pages it has already started printing and then cancels the remainder of the fax. This can take a few moments.

#### **To cancel a number you are dialing**

- ▲ Press **Cancel** to cancel a number you are currently dialing.

---

# 7 Configure and manage

This section is intended for the administrator or individual who is responsible for managing the device. This section contains information about the following topics.

- [Manage the device](#)
- [Use device management tools](#)
- [Set up faxing for the device](#)
- [Configure the device](#)
- [Uninstall and reinstall the software](#)

## Manage the device

The following, common tools can be used to manage the device. For information about accessing and using the tools, see [Use device management tools](#).

---

 **NOTE:** Specific procedures might include other methods.

---

### Windows

- Device control panel
- Printer driver
- Toolbox
- [Monitor the device](#)
- [Administer the device](#)

## Monitor the device

This section provides instructions for monitoring the device.

---

 **NOTE:** The ink levels shown are an estimate only. Actual ink volumes may vary.

---

Use this tool...	to obtain the following information....
Control panel	Obtain information about the status of jobs that are being processed, the operating status of the device, and the status of print cartridges.
Toolbox	<b>Print cartridge information:</b> Click the <b>Estimated Ink Levels</b> tab to view the ink-level information, and then scroll to display the <b>Cartridge Details</b> button. Click the <b>Cartridge Details</b> button to view information about replacement print cartridges and expiration dates.

## Administer the device

This section provides information about administering the device and modifying settings.

Use this tool...	to do the following...
Control panel	<ul style="list-style-type: none"> <li>• <b>Language and country/region:</b> Press <b>Setup</b>, and then open the <b>Preferences</b> menu. If you do not see your country/region, press 99, and then find your country/region in the list.</li> <li>• <b>Control panel volume:</b> Press <b>Setup</b>, and then open the <b>Preferences</b> menu.</li> <li>• <b>Fax sound volume:</b> Press <b>Setup</b>, and then select <b>Fax Sound Volume</b>.</li> <li>• <b>Automatic report printing:</b> Press <b>Setup</b>, and then open the <b>Advance Fax Setup</b> menu.</li> <li>• <b>Set the dial type:</b> Press <b>Setup</b>, and then open the <b>Basic Fax Setup</b> menu.</li> <li>• <b>Set up redial options:</b> Press <b>Setup</b>, and then open the <b>Advance Fax Setup</b> menu.</li> <li>• <b>Set the date and time:</b> Press <b>Setup</b>, press <b>Tools</b>, and then press <b>Date and Time</b>.</li> </ul>
Toolbox	<b>Perform device maintenance tasks:</b> Click the <b>Services</b> tab.

## Use device management tools

- [Toolbox](#)
- [Toolbox tabs](#)

### Toolbox

The Toolbox provides maintenance information about the device.

 **NOTE:** The Toolbox can be installed from the Starter CD by selecting the full installation option if the computer meets the system requirements.

#### To open the Toolbox

1. From the HP Solution Center, click the **Settings** menu, point to **Print Settings**, and then click **Printer Toolbox**.
2. Right-click the HP Digital Imaging Monitor in the tray, point to **Printer Model Name** and then click **Display Printer Toolbox**.

## Toolbox tabs

The Toolbox contains the following tabs.

Tabs	Contents
Estimated Ink Level	<ul style="list-style-type: none"><li>• <b>Ink Level Information:</b> Shows estimated ink level for each cartridge. <hr/><b>NOTE:</b> The ink levels shown are an estimate only. Actual ink volumes may vary.<hr/></li><li>• <b>Shop Online:</b> Provides access to a Web site from which you can order printing supplies for the device online.</li><li>• <b>Order by Phone:</b> Shows telephone numbers that you can call to order supplies for the device. Telephone numbers are not available for all countries/regions.</li><li>• <b>Cartridge Details:</b> Shows order numbers and expiration dates of the installed print cartridges.</li></ul>
Device Services	<ul style="list-style-type: none"><li>• <b>Align Print Cartridges:</b> Guides you through aligning the print cartridges. For more information, see <a href="#">Align the print cartridges</a>.</li><li>• <b>Clean Print Cartridges:</b> Guides you through cleaning the print cartridges. For more information, see <a href="#">Clean the print cartridges</a>.</li><li>• <b>Calibrate Color:</b> Allows you to perform linefeed calibration. For more information, see <a href="#">Calibrate color</a>.</li></ul>

## Set up faxing for the device

After completing all the steps in the getting started guide, use the instructions in this section to complete your fax setup. Keep your getting started guide for later use.

In this section, you will learn how to set up the device so that faxing works successfully with equipment and services you might already have on the same phone line.

 **TIP:** You can also use the Fax Setup Wizard to help you quickly set up some important fax settings such as the answer mode and fax header information. You can access the Fax Setup Wizard through the software you installed with the device. After you run the Fax Setup Wizard, follow the procedures in this section to complete your fax setup.

## Set up faxing (parallel phone systems)

Before you begin setting up the device for faxing, determine which kind of phone system your country/region uses. The instructions for fax setup differ depending on whether you have a serial- or parallel-type phone system.

- If you do not see your country/region listed in the table below, you probably have a serial-type phone system. In a serial-type phone system, the connector type on your shared telephone equipment (modems, phones, and answering machines) does not allow a physical connection to the "2-EXT" port on the device. Instead, all equipment must be connected at the telephone wall jack.

---

 **NOTE:** In some countries/regions that use serial-type phone systems, the phone cord that came with the device might have an additional wall plug attached to it. This enables you to connect other telecom devices to the wall jack where you plug in the device.

---

- If your country/region is listed in the table below, you probably have a parallel-type telephone system. In a parallel-type phone system, you are able to connect shared telephone equipment to the phone line by using the "2-EXT" port on the back of the device.

---

 **NOTE:** If you have a parallel-type phone system, HP recommends you use the 2-wire phone cord supplied with the device to connect it to the telephone wall jack.

---

**Table 7-1 Countries/regions with a parallel-type phone system**

Argentina	Australia	Brazil
Canada	Chile	China
Colombia	Greece	India
Indonesia	Ireland	Japan
Korea	Latin America	Malaysia
Mexico	Philippines	Poland
Portugal	Russia	Saudi Arabia
Singapore	Spain	Taiwan
Thailand	USA	Venezuela
Vietnam		

If you are unsure which kind of telephone system you have (serial or parallel), check with your telephone company.

### Choose the correct fax setup for your home or office

To fax successfully, you need to know what types of equipment and services (if any) share the same phone line with the device. This is important because you might need to connect some of your existing office equipment directly to the device, and you might also need to change some fax settings before you can fax successfully.

To determine the best way to set up the device in your home or office, first read through the questions in this section and record your answers. Next, refer to the table in the following section and choose the recommended setup case based on your answers.

Make sure to read and answer the following questions in the order they are presented.

1. Do you have a digital subscriber line (DSL) service through your telephone company? (DSL might be called ADSL in your country/region.)  
If you answered Yes, proceed directly to [Case B: Set up the device with DSL](#). You do not need to continue answering questions.  
If you answered No, continue answering questions.
2. Do you have a private branch exchange (PBX) phone system or an integrated services digital network (ISDN) system?  
If you answered Yes, proceed directly to [Case C: Set up the device with a PBX phone system or an ISDN line](#). You do not need to continue answering questions.  
If you answered No, continue answering questions.
3. Do you subscribe to a distinctive ring service through your telephone company that provides multiple phone numbers with different ring patterns?  
If you answered Yes, proceed directly to [Case D: Fax with a distinctive ring service on the same line](#). You do not need to continue answering questions.  
If you answered No, continue answering questions.  
Are you unsure if you have distinctive ring? Many phone companies offer a distinctive ring feature that allows you to have several phone numbers on one phone line.  
When you subscribe to this service, each phone number will have a different ring pattern. For example, you can have single, double, and triple rings for the different numbers. You might assign one phone number with a single ring to your voice calls, and another phone number with double rings to your fax calls. This allows you to tell the difference between voice and fax calls when the phone rings.
4. Do you receive voice calls at the same phone number you will use for fax calls on the device?  
Continue answering questions.
5. Do you have a computer dial-up modem on the same phone line as the device?  
Are you unsure if you use a computer dial-up modem? If you answer Yes to any of the following questions, you are using a computer dial-up modem:
  - Do you send and receive faxes directly to and from your computer software applications through a dial-up connection?
  - Do you send and receive e-mail messages on your computer through a dial-up connection?
  - Do you access the Internet from your computer through a dial-up connection?Continue answering questions.
6. Do you have an answering machine that answers voice calls at the same phone number you will use for fax calls on the device?  
Continue answering questions.
7. Do you subscribe to a voice mail service through your telephone company at the same phone number you will use for fax calls on the device?  
After you have completed answering the questions, proceed to the next section to select your fax setup case.

## Select your fax setup case

Now that you have answered all the questions about the equipment and services that share the phone line with the device, you are ready to choose the best setup case for your home or office.

From the first column in the following table, choose the combination of equipment and services applicable to your home or office setting. Then look up the appropriate setup case in the second or third column based on your phone system. Step-by-step instructions are included for each case in the sections that follow.

If you have answered all the questions in the previous section and have none of the described equipment or services, choose "None" from the first column in the table.

 **NOTE:** If your home or office setup is not described in this section, set up the device as you would a regular analog phone. Make sure you use the phone cord supplied in the box to connect one end to your telephone wall jack and the other end to the port labeled 1-LINE on the back of the device. If you use another phone cord, you might experience problems sending and receiving faxes.

Other equipment/services sharing your fax line	Recommended fax setup for parallel-type phone systems	Recommended fax setup for serial-type phone systems
None (You answered No to all questions.)	<a href="#">Case A: Separate fax line (no voice calls received)</a>	Refer to your country in <a href="#">Serial-type fax setup</a>
DSL service (You answered Yes to question 1 only.)	<a href="#">Case B: Set up the device with DSL</a>	Refer to your country in <a href="#">Serial-type fax setup</a>
PBX or ISDN system (You answered Yes to question 2 only.)	<a href="#">Case C: Set up the device with a PBX phone system or an ISDN line</a>	Refer to your country in <a href="#">Serial-type fax setup</a>
Distinctive ring service (You answered Yes to question 3 only.)	<a href="#">Case D: Fax with a distinctive ring service on the same line</a>	Refer to your country in <a href="#">Serial-type fax setup</a>
Voice calls (You answered Yes to question 4 only.)	<a href="#">Case E: Shared voice/fax line</a>	Refer to your country in <a href="#">Serial-type fax setup</a>
Voice calls and voice mail service (You answered Yes to questions 4 and 7 only.)	<a href="#">Case F: Shared voice/fax line with voice mail</a>	Refer to your country in <a href="#">Serial-type fax setup</a>
Computer dial-up modem (You answered Yes to question 5 only.)	<a href="#">Case G: Fax line shared with computer modem (no voice calls received)</a>	Not applicable.
Voice calls and computer dial-up modem (You answered Yes to questions 4 and 5 only.)	<a href="#">Case H: Shared voice/fax line with computer modem</a>	Not applicable.



(continued)

Other equipment/services sharing your fax line	Recommended fax setup for parallel-type phone systems	Recommended fax setup for serial-type phone systems
Voice calls and answering machine (You answered Yes to questions 4 and 6 only.)	<a href="#">Case I: Shared voice/fax line with answering machine</a>	Not applicable.
Voice calls, computer dial-up modem, and answering machine (You answered Yes to questions 4, 5, and 6 only.)	<a href="#">Case J: Shared voice/fax line with computer modem and answering machine</a>	Not applicable.
Voice calls, computer dial-up modem, and voice mail service (You answered Yes to questions 4, 5, and 7 only.)	<a href="#">Case K: Shared voice/fax line with computer dial-up modem and voice mail</a>	Not applicable.

### Case A: Separate fax line (no voice calls received)

If you have a separate phone line on which you receive no voice calls, and you have no other equipment connected on this phone line, set up the device as described in this section.

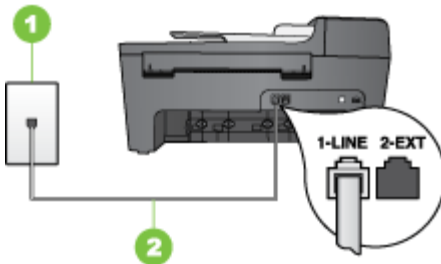



Figure 7-1 Back view of the device

1	Telephone wall jack
2	Use the phone cord supplied in the box with the device to connect to the 1-LINE port

### To set up the device with a separate fax line

1. Using the phone cord supplied in the box with the device, connect one end to your telephone wall jack, then connect the other end to the port labeled 1-LINE on the back of the device.

---

 **NOTE:** If you do not use the supplied cord to connect from the telephone wall jack to the device, you might not be able to fax successfully. This special phone cord is different from the phone cords you might already have in your home or office.

---

2. Turn on the **Auto Answer** setting.
3. (Optional) Change the **Rings to Answer** setting to the lowest setting (two rings).
4. Run a fax test. For more information, see [Test fax setup](#).

When the phone rings, the device answers automatically after the number of rings you set in the **Rings to Answer** setting. The device begins emitting fax reception tones to the sending fax machine and receives the fax.

### Case B: Set up the device with DSL

If you have a DSL service through your telephone company, and do not connect any equipment to the device, use the instructions in this section to connect a DSL filter between the telephone wall jack and the device. The DSL filter removes the digital signal that can interfere with the device, so the device can communicate properly with the phone line. (DSL might be called ADSL in your country/region.)

---

 **NOTE:** If you have a DSL line and you do not connect the DSL filter, you will not be able to send and receive faxes with the device.

---

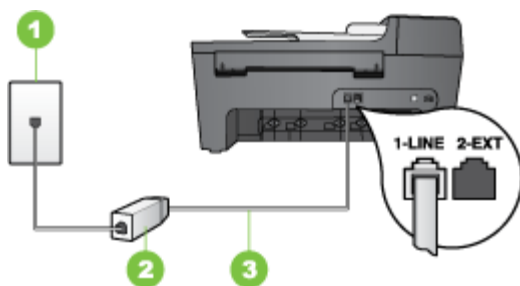

**Figure 7-2 Back view of the device**

1	Telephone wall jack
2	DSL (or ADSL) filter and cord supplied by your DSL provider
3	Use the phone cord supplied in the box with the device to connect to the 1-LINE port

### To set up the device with DSL

1. Obtain a DSL filter from your DSL provider.
2. Using the phone cord supplied in the box with the device, connect one end to the open port on the DSL filter, and then connect the other end to the port labeled 1-LINE on the back of the device.

---

 **NOTE:** If you do not use the supplied cord to connect from the DSL filter to the device, you might not be able to fax successfully. This special phone cord is different from the phone cords you might already have in your home or office.

As only one phone cord is supplied, you may will need to obtain additional phone cords for this setup.

---

3. Connect an additional phone cord from the DSL filter to the telephone wall jack.
4. Run a fax test. For more information, see [Test fax setup](#).

### Case C: Set up the device with a PBX phone system or an ISDN line

If you are using either a PBX phone system or an ISDN converter/terminal adapter, make sure you do the following:

- If you are using either a PBX or an ISDN converter/terminal adaptor, connect the device to the port that is designated for fax and phone use. Also, make sure that the terminal adapter is set to the correct switch type for your country/region, if possible.

---

 **NOTE:** Some ISDN systems allow you to configure the ports for specific phone equipment. For example, you might have assigned one port for telephone and Group 3 fax and another port for multiple purposes. If you have problems when connected to the fax/phone port of your ISDN converter, try using the port designated for multiple purposes; it might be labeled "multi-combi" or something similar.

---

- If you are using a PBX phone system, set the call waiting tone to "off."

---

 **NOTE:** Many digital PBX systems include a call-waiting tone that is set to "on" by default. The call waiting tone will interfere with any fax transmission, and you will not be able to send or receive faxes with the device. Refer to the documentation that came with your PBX phone system for instructions on how to turn off the call-waiting tone.

---

- If you are using a PBX phone system, dial the number for an outside line before dialing the fax number.
- Make sure you use the supplied cord to connect from the telephone wall jack to the device. If you do not, you might not be able to fax successfully. This special phone cord is different from the phone cords you might already have in your home or office. If the supplied phone cord is too short, you can purchase a coupler from your local electronics store and extend it.

### Case D: Fax with a distinctive ring service on the same line

If you subscribe to a distinctive ring service (through your telephone company) that allows you to have multiple phone numbers on one phone line, each with a different ring pattern, set up the device as described in this section.

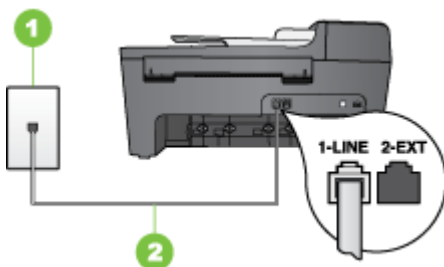

**Figure 7-3 Back view of the device**

1	Telephone wall jack
2	Use the phone cord supplied in the box with the device to connect to the 1-LINE port

### To set up the device with a distinctive ring service

- Using the phone cord supplied in the box with the device, connect one end to your telephone wall jack, then connect the other end to the port labeled 1-LINE on the back of the device.

 **NOTE:** If you do not use the supplied cord to connect from the telephone wall jack to the device, you might not be able to fax successfully. This special phone cord is different from the phone cords you might already have in your home or office.

- Turn on the **Auto Answer** setting.
- Change the **Distinctive Ring** setting to match the pattern that the telephone company assigned to your fax number.

 **NOTE:** By default, the device is set to answer all ring patterns. If you do not set the **Distinctive Ring** to match the ring pattern assigned to your fax number, the device might answer both voice calls and fax calls or it might not answer at all.

- (Optional) Change the **Rings to Answer** setting to the lowest setting (two rings).
- Run a fax test. For more information, see [Test fax setup](#).

The device automatically answers incoming calls that have the ring pattern you selected (**Distinctive Ring** setting) after the number of rings you selected (**Rings to Answer** setting). The device begins emitting fax reception tones to the sending fax machine and receives the fax.

### Case E: Shared voice/fax line

If you receive both voice calls and fax calls at the same phone number, and you have no other office equipment (or voice mail) on this phone line, set up the device as described in this section.

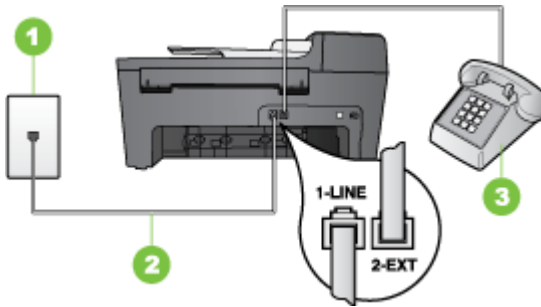



Figure 7-4 Back view of the device

1	Telephone wall jack
2	Use the phone cord supplied in the box with the device to connect to the 1-LINE port
3	Telephone (optional)

### To set up the device with a shared voice/fax line

1. Using the phone cord supplied in the box with the device, connect one end to your telephone wall jack, then connect the other end to the port labeled 1-LINE on the back of the device.

 **NOTE:** If you do not use the supplied cord to connect from the telephone wall jack to the device, you might not be able to fax successfully. This special phone cord is different from the phone cords you might already have in your home or office.

2. Do one of the following:
  - If you have a parallel-type phone system, remove the white plug from the port labeled 2-EXT on the back of the device, and then connect a phone to this port.
  - If you have a serial-type phone system, you might plug your phone directly on top of the device cable which has a wall plug attached to it.

3. Now you need to decide how you want the device to answer calls, automatically or manually:
  - If you set up the device to answer calls **automatically**, it answers all incoming calls and receives faxes. The device will not be able to distinguish between fax and voice calls in this case; if you suspect the call is a voice call, you will need to answer it before the device answers the call. To set up the device to answer calls automatically, turn on the **Auto Answer** setting.
  - If you set up the device to answer faxes **manually**, you must be available to respond in person to incoming fax calls or the device cannot receive faxes. To set up the device to answer calls manually, turn off the **Auto Answer** setting.
4. Run a fax test. For more information, see [Test fax setup](#).

If you pick up the phone before the device answers the call and hear fax tones from a sending fax machine, you will need to answer the fax call manually.

### Case F: Shared voice/fax line with voice mail

If you receive both voice calls and fax calls at the same phone number, and you also subscribe to a voice mail service through your telephone company, set up the device as described in this section.

---

 **NOTE:** You cannot receive faxes automatically if you have a voice mail service at the same phone number you use for fax calls. You must receive faxes manually; this means you must be available to respond in person to incoming fax calls. If you want to receive faxes automatically instead, contact your telephone company to subscribe to a distinctive ring service, or to obtain a separate phone line for faxing.

---

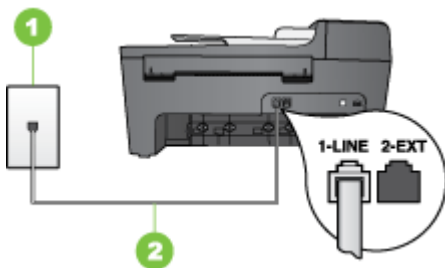

**Figure 7-5 Back view of the device**

1	Telephone wall jack
2	Use the phone cord supplied in the box with the device to connect to the "1-LINE" port

## To set up the device with voice mail

1. Using the phone cord supplied in the box with the device, connect one end to your telephone wall jack, then connect the other end to the port labeled 1-LINE on the back of the device.

---

 **NOTE:** If you do not use the supplied cord to connect from the telephone wall jack to the device, you might not be able to fax successfully. This special phone cord is different from the phone cords you might already have in your home or office.

---

2. Turn off the **Auto Answer** setting.
3. Run a fax test. For more information, see [Test fax setup](#).

You must be available to respond in person to incoming fax calls and answer the fax before the voicemail picks up, or the device cannot receive faxes.

## Case G: Fax line shared with computer modem (no voice calls received)

If you have a fax line on which you receive no voice calls, and you also have a computer modem connected on this line, set up the device as described in this section.

 **NOTE:** If you have a computer dial-up modem, your computer dial-up modem shares the phone line with the device. You will not be able to use both your modem and the device simultaneously. For example, you cannot use the device for faxing while you are using your computer dial-up modem to send an e-mail or access the Internet.

---

- [Set up the device with a computer dial-up modem](#)
- [Set up the device with a computer DSL/ADSL modem](#)

## Set up the device with a computer dial-up modem

If you are using the same phone line for sending faxes and for a computer dial-up modem, follow these directions for setting up the device.

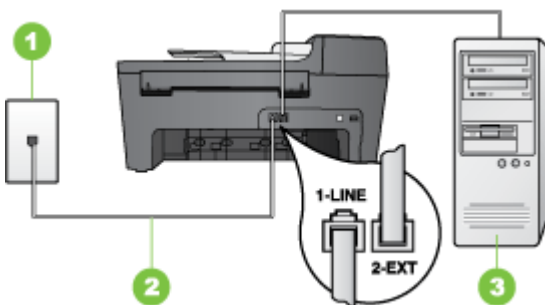

**Figure 7-6 Back view of the device**

1	Telephone wall jack
2	Use the phone cord supplied in the box with the device to connect to the "1-LINE" port

3	Computer with modem
---	---------------------

### To set up the device with a computer dial-up modem

1. Remove the white plug from the port labeled 2-EXT on the back of the device.
2. Find the phone cord that connects from the back of your computer (your computer dial-up modem) to a telephone wall jack. Disconnect the cord from the telephone wall jack and plug it into the port labeled 2-EXT on the back of the device.
3. Using the phone cord supplied in the box with the device, connect one end to your telephone wall jack, then connect the other end to the port labeled 1-LINE on the back of the device.

 **NOTE:** If you do not use the supplied cord to connect from the telephone wall jack to the device, you might not be able to fax successfully. This special phone cord is different from the phone cords you might already have in your home or office.

4. If your modem software is set to receive faxes to your computer automatically, turn off that setting.

 **NOTE:** If you do not turn off the automatic fax reception setting in your modem software, the HP device will not be able to receive faxes.

5. Turn on the **Auto Answer** setting.
6. (Optional) Change the **Rings to Answer** setting to the lowest setting (two rings).
7. Run a fax test. For more information, see [Test fax setup](#).

When the phone rings, the device automatically answers after the number of rings you set in the **Rings to Answer** setting. The device begins emitting fax reception tones to the sending fax machine and receives the fax.

### Set up the device with a computer DSL/ADSL modem

If you have a DSL line and use that phone line to send faxes, follow these instructions to set up your fax.

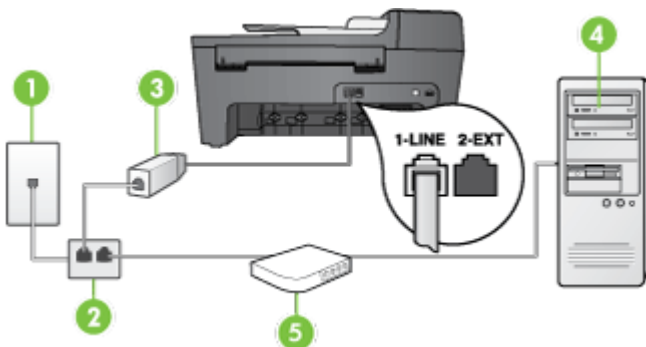



1	Telephone wall jack
2	Parallel splitter
3	DSL/ADSL filter Connect one end of the phone jack that was supplied with the device to connect to the 1-LINE port on the back of the device. Connect the other end of the cord to the DSL/ADSL filter.
4	Computer
5	Computer DSL/ADSL modem

 **NOTE:** You will need to purchase a parallel splitter (also called a coupler). A parallel splitter has one RJ-11 port on the front and two RJ-11 ports on the back. Do not use a 2-line phone splitter, a serial splitter, or a parallel splitter which has two RJ-11 ports on the front and a plug on the back.



### To set up the device with a computer DSL/ADSL modem

1. Obtain a DSL filter from your DSL provider.
2. Using the phone cord provided in the box with the device, connect one end to the DSL filter, and then connect the other end to the port labeled 1-LINE on the back of the device.

 **NOTE:** If you do not use the supplied cord to connect from the DSL filter to the back of the device, you might not be able to fax successfully. This special phone cord is different from the phone cords you might already have in your home or office.

3. Connect the DSL filter to the parallel splitter.
4. Connect the DSL modem to the parallel splitter.
5. Connect the parallel splitter to the wall jack.
6. Run a fax test. For more information, see [Test fax setup](#).

When the phone rings, the device automatically answers after the number of rings you set in the **Rings to Answer** setting. The device begins emitting fax reception tones to the sending fax machine and receives the fax.

### Case H: Shared voice/fax line with computer modem

If you receive both voice calls and fax calls at the same phone number, and you also have a computer modem connected on this phone line, set up the device as described in this section.

 **NOTE:** Since your computer modem shares the phone line with the device, you cannot use both your modem and the device simultaneously. For example, you cannot use the device for faxing while you are using your computer modem to send an e-mail or access the Internet.

- [Shared voice/fax with computer dial-up modem](#)
- [Shared voice/fax with computer DSL/ADSL modem](#)

### Shared voice/fax with computer dial-up modem

If you use your phone line for both fax and telephone calls, use these instructions to set up your fax.

There are two different ways to set up the device with your computer based on the number of phone ports on your computer. Before you begin, check your computer to see if it has one or two phone ports.

- If your computer has only one phone port, you will need to purchase a parallel splitter (also called a coupler), as shown below. (A parallel splitter has one RJ-11 port on the front and two RJ-11 ports on the back. Do not use a two-line phone splitter, a serial splitter, or a parallel splitter which has two RJ-11 ports on the front and a plug on the back.)



**Figure 7-7 Example of a parallel splitter**

- If your computer has one phone port, set up the device as described below.

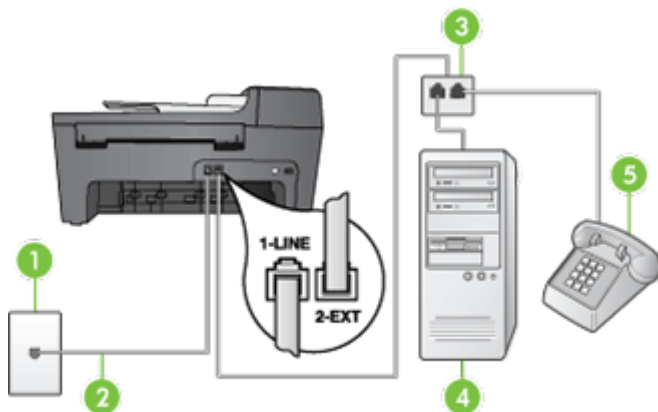

**Figure 7-8 Back view of the device**

1	Telephone wall jack
2	Phone cord provided with the device plugged into the 1-LINE port on the back of the device
3	Parallel splitter
4	Computer
5	Telephone

**To set up the device on the same phone line as a computer with one phone port**

1. Remove the white plug from the port labeled 2-EXT on the back of the device.
2. Find the phone cord that connects from the back of your computer (your computer dial-up modem) to a telephone wall jack. Disconnect the cord from the telephone wall jack and plug it into the parallel splitter.
3. Connect a phone cord from the parallel splitter to the port labeled 2-EXT on the back of the device.
4. Connect a phone to the parallel splitter.
5. Using the phone cord supplied in the box with the device, connect one end to your telephone wall jack, then connect the other end to the port labeled 1-LINE on the back of the device.

---

 **NOTE:** If you do not use the supplied cord to connect from the telephone wall jack to the device, you might not be able to fax successfully. This special phone cord is different from the phone cords you might already have in your home or office.

---

6. If your modem software is set to receive faxes to your computer automatically, turn off that setting.

---

 **NOTE:** If you do not turn off the automatic fax reception setting in your modem software, the device will not be able to receive faxes.

---

7. Now you need to decide how you want the device to answer calls, automatically or manually:
  - If you set up the device to answer calls **automatically**, it answers all incoming calls and receives faxes. The device will not be able to distinguish between fax and voice calls in this case; if you suspect the call is a voice call, you will need to answer it before the device answers the call. To set up the device to answer calls automatically, turn on the **Auto Answer** setting.
  - If you set up the device to answer faxes **manually**, you must be available to respond in person to incoming fax calls or the device cannot receive faxes. To set up the device to answer calls manually, turn off the **Auto Answer** setting.
8. Run a fax test. For more information, see [Test fax setup](#).

---

 **NOTE:** If your computer has two telephone ports on the back, you do not need to use a parallel splitter. You can plug the telephone into the “OUT” port on the computer dial-up modem.

---

If you pick up the phone before the device answers the call and hear fax tones from a sending fax machine, you will need to answer the fax call manually.

If you use your phone line for voice, fax, and your computer dial-up modem, follow these directions to set up your fax.

**Shared voice/fax with computer DSL/ADSL modem**

Use these instructions if your computer has a DSL/ADSL modem.

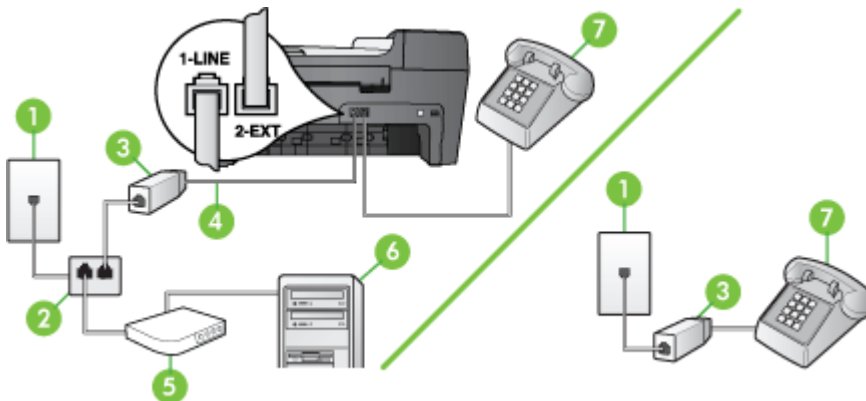

1	Telephone wall jack
2	Parallel splitter
3	DSL/ADSL filter
4	Phone cord supplied with the device
5	DSL/ADSL modem
6	Computer
7	Telephone

**NOTE:** You will need to purchase a parallel splitter (also called a coupler). A parallel splitter has one RJ-11 port on the front and two RJ-11 ports on the back. Do not use a 2-line phone splitter, a serial splitter, or a parallel splitter which has two RJ-11 ports on the front and a plug on the back.



## To set up the device with a computer DSL/ADSL modem

1. Obtain a DSL filter from your DSL provider.

 **NOTE:** Phones in other parts of the home/office sharing the same phone number with DSL service will need to be connected to additional DSL filters, otherwise you will experience noise when making voice calls.

2. Using the phone cord supplied in the box with the devices, connect one end to the DSL filter, then connect the other end to the port labeled 1-LINE on the back of the device.

 **NOTE:** If you do not use the supplied cord to connect from the DSL filter to the device, you might not be able to fax successfully. This special phone cord is different from phone cords you might already have in your home or office.

3. If you have a parallel-type phone system, remove the white plug from the port labeled 2-EXT on the back of the device, and then connect a phone to this port.
4. Connect the DSL filter to the parallel splitter.
5. Connect the DSL modem to the parallel splitter.
6. Connect the parallel splitter to the wall jack.
7. Run a fax test. For more information, see [Test fax setup](#).

When the phone rings, the device automatically answers after the number of rings you set in the **Rings to Answer** setting. The device begins emitting fax reception tones to the sending fax machine and receives the fax.

### Case I: Shared voice/fax line with answering machine

If you receive both voice calls and fax calls at the same phone number, and you also have an answering machine that answers voice calls at this phone number, set up the device as described in this section.

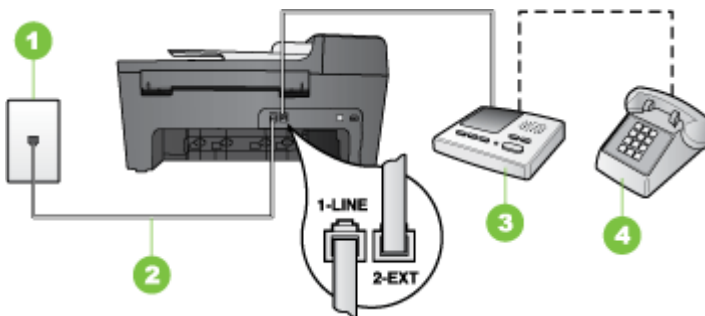

Figure 7-9 Back view of the device

1	Telephone wall jack
2	Use the phone cord provided to connect to the 1-LINE port on the back of the device
3	Answering machine

(continued)

4	Telephone (optional)
---	----------------------

### To set up the device with a shared voice/fax line with answering machine

1. Remove the white plug from the port labeled 2-EXT on the back of the device.
2. Unplug your answering machine from the telephone wall jack, and connect it to the port labeled 2-EXT on the back of the device.



**NOTE:** If you do not connect your answering machine directly to the device, fax tones from a sending fax machine might be recorded on your answering machine, and you might not be able to receive faxes with the device.

3. Using the phone cord supplied in the box with the device, connect one end to your telephone wall jack, then connect the other end to the port labeled 1-LINE on the back of the device.



**NOTE:** If you do not use the supplied cord to connect from the telephone wall jack to the device, you might not be able to fax successfully. This special phone cord is different from the phone cords you might already have in your home or office.

4. (Optional) If your answering machine does not have a built-in phone, for convenience you might want to connect a phone to the back of your answering machine at the "OUT" port.



**NOTE:** If your answering machine does not let you connect an external phone, you can purchase and use a parallel splitter (also known as a coupler) to connect both the answering machine and telephone to the device. You can use standard phone cords for these connections.

5. Turn on the **Auto Answer** setting.
6. Set your answering machine to answer after a low number of rings.
7. Change the **Rings to Answer** setting on the device to the maximum number of rings supported by your device. (The maximum number of rings varies by country/region.)
8. Run a fax test. For more information, see [Test fax setup](#).

When the phone rings, your answering machine answers after the number of rings you have set, and then plays your recorded greeting. The HP device monitors the call during this time, "listening" for fax tones. If incoming fax tones are detected, the HP device emits fax reception tones and receives the fax; if there are no fax tones, the HP device stops monitoring the line and your answering machine can record a voice message.

### Case J: Shared voice/fax line with computer modem and answering machine

If you receive both voice calls and fax calls at the same phone number, and you also have a computer modem and answering machine connected on this phone line, set up the HP device as described in this section.

 **NOTE:** Since your computer dial-up modem shares the phone line with the HP device, you cannot use both your modem and the HP device simultaneously. For example, you cannot use the HP device for faxing while you are using your computer dial-up modem to send an e-mail or access the Internet.

- [Shared voice/fax line with computer dial-up modem and answering machine](#)
- [Shared voice/fax line with computer DSL/ADSL modem and answering machine](#)

### Shared voice/fax line with computer dial-up modem and answering machine

There are two different ways to set the device with your computer based on the number of phone ports on your computer. Before you begin, check your computer to see if it has one or two phone ports.

- If your computer has only one phone port, you will need to purchase a parallel splitter (also called a coupler), as shown below. (A parallel splitter has one RJ-11 port on the front and two RJ-11 ports on the back. Do not use a two-line phone splitter, a serial splitter, or a parallel splitter which has two RJ-11 ports on the front and a plug on the back.)



**Figure 7-10 Example of a parallel splitter**

- If your computer has one phone port, set up the HP device as described below.

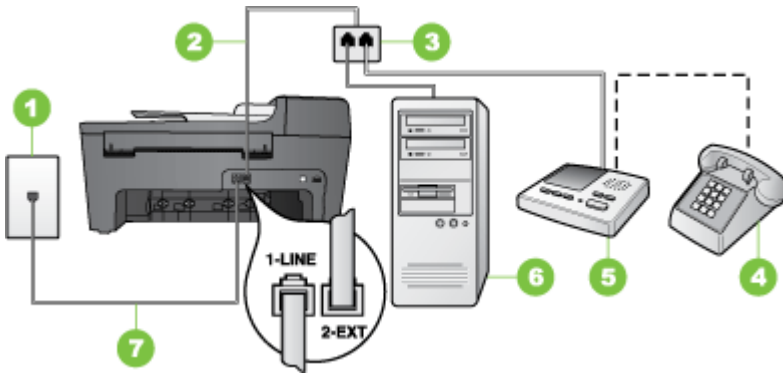

**Figure 7-11 Back view of the device**

1	Telephone wall jack
2	Telephone cord connected to the parallel splitter
3	Parallel splitter
4	Telephone (optional)

5	Answering machine
6	Computer with modem
7	Use the phone cord supplied in the box with the device to connect to the "1-LINE" port

### To set up the HP device on the same phone line as a computer with one phone port

1. Remove the white plug from the port labeled 2-EXT on the back of the HP device.
2. Find the phone cord that connects from the back of your computer (your computer dial-up modem) to a telephone wall jack. Disconnect the cord from the telephone wall jack and plug it into the port labeled 2-EXT on the back of the HP device.
3. Unplug your answering machine from the telephone wall jack, and connect it to the port labeled 2-EXT on the back of the HP device.

---

 **NOTE:** If you do not connect your answering machine directly to the device, fax tones from a sending fax machine might be recorded on your answering machine, and you probably will not be able to receive faxes with the device.

---

4. Using the phone cord supplied in the box with the HP device, connect one end to your telephone wall jack, then connect the other end to the port labeled 1-LINE on the back of the HP device.

---

 **NOTE:** If you do not use the supplied cord to connect from the telephone wall jack to the device, you might not be able to fax successfully. This special phone cord is different from the phone cords you might already have in your home or office.

---

5. (Optional) If your answering machine does not have a built-in phone, for convenience you might want to connect a phone to the back of your answering machine at the "OUT" port.

---

 **NOTE:** If your answering machine does not let you connect an external phone, you can purchase and use a parallel splitter (also known as a coupler) to connect both the answering machine and telephone to the device. You can use standard phone cords for these connections.

---

6. If your modem software is set to receive faxes to your computer automatically, turn off that setting.

---

 **NOTE:** If you do not turn off the automatic fax reception setting in your modem software, the device will not be able to receive faxes.

---

7. Turn on the **Auto Answer** setting.
8. Set your answering machine to answer after a low number of rings.



9. Change the **Rings to Answer** setting on the HP device to the maximum number of rings supported by your HP device. (The maximum number of rings varies by country/region.)
10. Run a fax test. For more information, see [Test fax setup](#).

 **NOTE:** If you are using a computer with two telephone ports, you do not need a parallel splitter. You can plug the answering machine into the "OUT" port on the back of the computer.

When the phone rings, your answering machine answers after the number of rings you have set, and then plays your recorded greeting. The device monitors the call during this time, "listening" for fax tones. If incoming fax tones are detected, the device emits fax reception tones and receives the fax; if there are no fax tones, the device stops monitoring the line and your answering machine can record a voice message.

### Shared voice/fax line with computer DSL/ADSL modem and answering machine

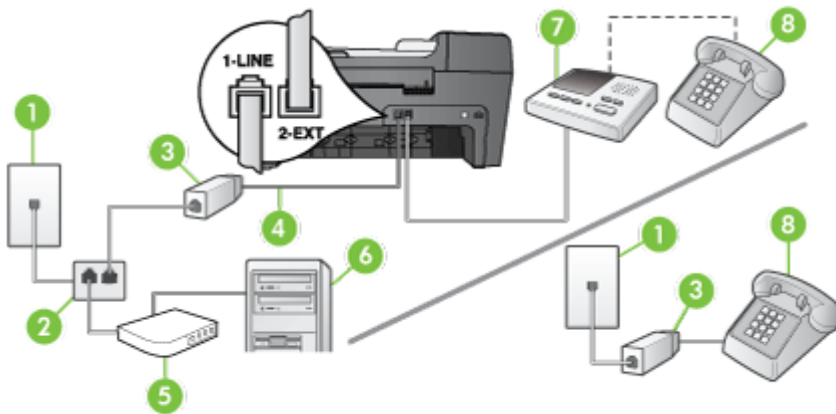

1	Telephone wall jack
2	Parallel splitter
3	DSL/ADSL filter
4	Phone cord provided with the device connected to the 1-LINE port on the back of the device
5	DSL/ADSL modem
6	Computer
7	Answering machine
8	Telephone (optional)

---

 **NOTE:** You will need to purchase a parallel splitter (also called a coupler). A parallel splitter has one RJ-11 port on the front and two RJ-11 ports on the back. Do not use a 2-line phone splitter, a serial splitter, or a parallel splitter which has two RJ-11 ports on the front and a plug on the back.

---



### To set up the device with a computer DSL/ADSL modem

1. Obtain a DSL/ADSL filter from your DSL/ADSL provider.

---

 **NOTE:** Phones in other parts of the home/office sharing the same phone number with DSL/ADSL service will need to be connected to additional DSL/ADSL filters, otherwise you will experience noise when making voice calls.

---

2. Using the phone cord supplied in the box with the device, connect one end to the DSL/ADSL filter, then connect the other end to the port labeled 1-LINE on the back of the device.

---

 **NOTE:** If you do not use the supplied cord to connect from the DSL/ADSL filter to the device, you might not be able to fax successfully. This special phone cord is different from the phone cords you might already have in your home or office.

---

3. Connect the DSL/ADSL filter to the splitter.
4. Unplug the answering machine from the telephone wall jack, and connect it to the port labeled 2-EXT on the back of the device.

---

 **NOTE:** If you do not connect your answering machine directly to the device, fax tones from a sending fax machine might be recorded on your answering machine, and you probably will not be able to receive faxes with the device.

---

5. Connect the DSL modem to the parallel splitter.
6. Connect the parallel splitter to the wall jack.
7. Set your answering machine to answer after a low number of rings.
8. Change your **Rings to Answer** setting on the device to the maximum number of rings supported by the device.

---

 **NOTE:** The maximum number of rings varies by country/region.

---

9. Run a fax test. For more information, see [Test fax setup](#).

When the phone rings, your answering machine will answer after the number of rings you have set, and then play your recorded greeting. The device monitors the call during this time, “listening” for fax tones. If incoming fax tones are detected, the device will emit fax reception tones and receive the fax; if there are no fax tones, the device stops monitoring the line and your answering machine can record a voice message.

If you use the same phone line for telephone, fax, and have a computer DSL modem, follow these instructions to set up your fax.

### Case K: Shared voice/fax line with computer dial-up modem and voice mail

If you receive both voice calls and fax calls at the same phone number, use a computer dial-up modem on the same phone line, and subscribe to a voice mail service through your telephone company, set up the device as described in this section.

 **NOTE:** You cannot receive faxes automatically if you have a voice mail service at the same phone number you use for fax calls. You must receive faxes manually; this means you must be available to respond in person to incoming fax calls. If you want to receive faxes automatically instead, contact your telephone company to subscribe to a distinctive ring service, or to obtain a separate phone line for faxing.

Since your computer dial-up modem shares the phone line with the device, you cannot use both your modem and the device simultaneously. For example, you cannot use the device for faxing if you are using your computer dial-up modem to send an e-mail or access the Internet.

There are two different ways to set up the device with your computer based on the number of phone ports on your computer. Before you begin, check your computer to see if it has one or two phone ports.

- If your computer has only one phone port, you will need to purchase a parallel splitter (also called a coupler), as shown below. (A parallel splitter has one RJ-11 port on the front and two RJ-11 ports on the back. Do not use a two-line phone splitter, a serial splitter, or a parallel splitter which has two RJ-11 ports on the front and a plug on the back.)



**Figure 7-12 Example of a parallel splitter**

- If your computer has two phone ports, set up the device as described below.

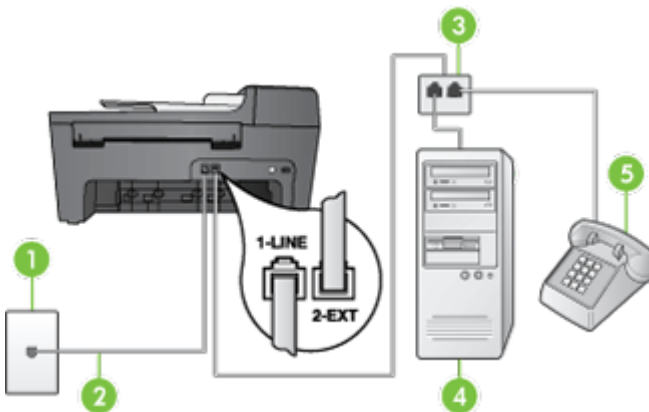

**Figure 7-13 Back view of the device**

1	Telephone wall jack
2	Use the phone cord supplied in the box with the device to connect to the 1-LINE port
3	Parallel splitter
4	Computer with modem
5	Telephone

### To set up the device on the same phone line as a computer with two phone ports

1. Remove the white plug from the port labeled 2-EXT on the back of the device.
2. Find the phone cord that connects from the back of your computer (your computer dial-up modem) to a telephone wall jack. Disconnect the cord from the telephone wall jack and plug it into the port labeled 2-EXT on the back of the device.
3. Connect a phone to the "OUT" port on the back of your computer dial-up modem.
4. Using the phone cord supplied in the box with the device, connect one end to your telephone wall jack, then connect the other end to the port labeled 1-LINE on the back of the device.

---

 **NOTE:** If you do not use the supplied cord to connect from the telephone wall jack to the device, you might not be able to fax successfully. This special phone cord is different from the phone cords you might already have in your home or office.

---

5. If your modem software is set to receive faxes to your computer automatically, turn off that setting.

---

 **NOTE:** If you do not turn off the automatic fax reception setting in your modem software, the device will not be able to receive faxes.

---

6. Turn off the **Auto Answer** setting.
7. Run a fax test. For more information, see [Test fax setup](#).

You must be available to respond in person to incoming fax calls, or the device cannot receive faxes.

### Serial-type fax setup

For information on setting up the device for faxing using a serial-type phone system, see the Fax Configuration Web site for your country/region.

Austria	<a href="http://www.hp.com/at/faxconfig">www.hp.com/at/faxconfig</a>
Germany	<a href="http://www.hp.com/de/faxconfig">www.hp.com/de/faxconfig</a>
Switzerland (French)	<a href="http://www.hp.com/ch/fr/faxconfig">www.hp.com/ch/fr/faxconfig</a>
Switzerland (German)	<a href="http://www.hp.com/ch/de/faxconfig">www.hp.com/ch/de/faxconfig</a>
United Kingdom	<a href="http://www.hp.com/uk/faxconfig">www.hp.com/uk/faxconfig</a>
Finland	<a href="http://www.hp.fi/faxconfig">www.hp.fi/faxconfig</a>

(continued)

Denmark	<a href="http://www.hp.dk/faxconfig">www.hp.dk/faxconfig</a>
Sweden	<a href="http://www.hp.se/faxconfig">www.hp.se/faxconfig</a>
Norway	<a href="http://www.hp.no/faxconfig">www.hp.no/faxconfig</a>
Netherlands	<a href="http://www.hp.nl/faxconfig">www.hp.nl/faxconfig</a>
Belgium (Dutch)	<a href="http://www.hp.be/nl/faxconfig">www.hp.be/nl/faxconfig</a>
Belguim (French)	<a href="http://www.hp.be/fr/faxconfig">www.hp.be/fr/faxconfig</a>
Portugal	<a href="http://www.hp.pt/faxconfig">www.hp.pt/faxconfig</a>
Spain	<a href="http://www.hp.es/faxconfig">www.hp.es/faxconfig</a>
France	<a href="http://www.hp.com/fr/faxconfig">www.hp.com/fr/faxconfig</a>
Ireland	<a href="http://www.hp.com/ie/faxconfig">www.hp.com/ie/faxconfig</a>
Italy	<a href="http://www.hp.com/it/faxconfig">www.hp.com/it/faxconfig</a>

## Configure the device

You can connect the device directly to a computer, or you can share the device among other users on a network.

---

 **NOTE:** Microsoft Internet Explorer 6.0 or later must be installed on the computer system to run the installation program.

You must have administrator privileges to install a printer driver on Windows 2000, Windows XP, or Windows Vista.

---

When setting up the device, HP recommends that you connect it after you install the software because the installation program is designed to provide you with the easiest setup experience. However, if you have connected the cable first, see [Connect the device before installing the software](#).

### Direct connection

You can connect the device directly to your computer using a USB cable.

---

 **NOTE:** If you install the device software and connect the device to a computer running Windows, you can connect additional devices to the same computer with USB cables without reinstalling the device software.

---

When setting up the device, HP recommends that you connect the device after you install the software because the installation program is designed to provide you with the easiest setup experience. However, if you have connected the cable first, see [Connect the device before installing the software](#).

## Install the software before connecting the device (recommended)

### To install the software

1. Close any applications that are running.
2. Insert the Starter CD into the CD drive. The CD menu runs automatically. If the CD menu does not start automatically, double-click the setup icon on the Starter CD.
3. On the CD menu, click **Install** and follow the onscreen instructions.
4. When prompted, turn on the device and connect it to the computer using a USB cable. The **Found New Hardware** wizard appears on the computer screen, and the device icon is created in the Printers folder.

---

 **NOTE:** You may connect the USB cable at a later time when you need to use the device.

You can also share the device with other computers using a simple form of networking known as locally shared networking. For more information, see [Share the device on a locally shared network](#).

---

### Connect the device before installing the software

If you connected the device to the computer before installing the device software, the **Found New Hardware** wizard displays on the computer screen.

---

 **NOTE:** If you turned on the device, do not turn it off or unplug the cable from the device while the installation program is running. If you do so, the installation program will not finish.

---

### To connect the device

1. In the **Found New Hardware** dialog box that displays methods for locating the printer driver, select the Advanced option, and then click **Next**.

---

 **NOTE:** Do not allow the **Found New Hardware** wizard to perform an automatic search for the printer driver.

---

2. Select the check box for specifying the driver location, and ensure that the other check boxes are clear.
3. Insert the Starter CD into the CD drive. If the CD menu appears, close it.
4. Browse to locate the root directory on the Starter CD (for example, D), and then click **OK**.
5. Click **Next** and follow the onscreen instructions.
6. Click **Finish** to close the **Found New Hardware** wizard. The wizard automatically starts the installation program (this might take a short while).
7. Complete the installation process.

---

 **NOTE:** You can also share the device with other computers using a simple form of networking known as locally shared networking. For more information, see [Share the device on a locally shared network](#).

---

## Share the device on a locally shared network

In a locally shared network, the device is connected directly to the USB connector of a selected computer (known as the server) and is shared by other computers (clients).

 **NOTE:** When sharing a directly connected device, use the computer with the newest operating system as the server. For example, if you have a computer running Windows XP and another computer running an older version of Windows, use the computer running Windows XP as the server.

Use this configuration only in small groups or when usage is low. The connected computer is slowed down when many users print to the device.

Only the printing function is shared. Scan, Copy, and Fax functions are not shared.

---

### To share the device

1. Click **Start**, point to **Settings**, and then click **Printers** or **Printers and Faxes**.  
- Or -  
Click **Start**, click **Control Panel**, and then double-click **Printers**.
2. Right-click the device icon, click **Properties**, and then click the **Sharing** tab.
3. Click the option to share the device, and give it a share name.
4. To share the device with client computers that use other versions of Windows, click **Additional Drivers** to install those drivers as a convenience to the users. You must have the Starter CD in your CD drive.

## Uninstall and reinstall the software

If your installation is incomplete, or if you connected the USB cable to the computer before prompted by the software installation screen, you might need to uninstall and then reinstall the software. Do not simply delete the device application files from your computer. Make sure to remove them properly using the uninstall utility provided when you installed the software that came with the device.

There are three methods to uninstall the software on a Windows computer.

### To uninstall from a Windows computer, method 1

1. Disconnect the device from your computer. Do not connect it to your computer until after you have reinstalled the software.
2. Press the **Power** button to turn off the device.
3. On the Windows taskbar, click **Start**, select **Programs** or **All Programs**, select **HP**, select **Officejet J5500 Series**, and then click **Uninstall**.
4. Follow the onscreen instructions.
5. If you are asked whether you would like to remove shared files, click **No**.  
Other programs that use these files might not work properly if the files are deleted.
6. Restart your computer.
7. To reinstall the software, insert the device Starter CD into your computer's CD-ROM drive, follow the onscreen instructions, and also see [Install the software before connecting the device \(recommended\)](#).
8. After the software is installed, connect the device to your computer.

9. Press the **Power** button to turn the device on.  
After connecting and turning on the device, you might have to wait several minutes for all of the Plug and Play events to complete.
10. Follow the onscreen instructions.

When the software installation is complete, the **HP Digital Imaging Monitor** icon appears in the Windows system tray.

### To uninstall from a Windows computer, method 2

---

 **NOTE:** Use this method if **Uninstall** is not available in the Windows Start menu.

---

1. On the Windows taskbar, click **Start**, select **Settings**, select **Control Panel**, and then click **Add/Remove Programs**.  
- Or -  
Click **Start**, click **Control Panel**, and then double-click **Programs and Features**.
2. Select **HP Officejet All-in-One Series**, and then click **Change/Remove** or **Uninstall/Change**.  
Follow the onscreen instructions.
3. Disconnect the device from your computer.
4. Restart your computer.

---

 **NOTE:** It is important that you disconnect the device before restarting your computer. Do not connect the device to your computer until after you have reinstalled the software.

---

5. Insert the device Starter CD into your computer's CD-ROM drive and then start the Setup program.
6. Follow the onscreen instructions and also see [Install the software before connecting the device \(recommended\)](#).

### To uninstall from a Windows computer, method 3

---

 **NOTE:** Use this method if **Uninstall** is not available in the Windows Start menu.

---

1. Insert the device Starter CD into your computer's CD-ROM drive, and then start the Setup program.
2. Disconnect the device from your computer.
3. Select **Uninstall** and follow the onscreen directions.
4. Restart your computer.

---

 **NOTE:** It is important that you disconnect the device before restarting your computer. Do not connect the device to your computer until after you have reinstalled the software.

---

5. Start the Setup program for the device again.
6. Select **Install**.
7. Follow the onscreen instructions and also see [Install the software before connecting the device \(recommended\)](#).



---

# 8 Maintain and troubleshoot

This section contains the following topics:

- [Work with print cartridges](#)
- [Clean the device](#)
- [Troubleshooting tips and resources](#)
- [Solve printing problems](#)
- [Poor print quality and unexpected printouts](#)
- [Solve paper-feed problems](#)
- [Solve copy problems](#)
- [Solve scan problems](#)
- [Solve fax problems](#)
- [Troubleshoot installation issues](#)
- [Clear paper jams](#)
- [Avoid paper jams](#)

## Work with print cartridges

To ensure the best print quality from the device, you will need to perform some simple maintenance procedures and, when prompted by a message on the display, replace the print cartridges.

This section contains the following topics:

- [Supported print cartridges](#)
- [Handle the print cartridges](#)
- [Replace the print cartridges](#)
- [Align the print cartridges](#)
- [Calibrate color](#)
- [Clean the print cartridges](#)
- [Clean the print cartridge contacts](#)
- [Clean the area around the ink nozzles](#)
- [Use a photo print cartridge](#)
- [Store printing supplies](#)

## Supported print cartridges

The availability of print cartridges varies by country/region. The print cartridges might come in different sizes.

You can find the print cartridge number in the following places:

- On the label of the print cartridge you are replacing.
- **Windows:** From the **Toolbox**, if you have bidirectional communication, click the **Estimated Ink Levels** tab, scroll to display the **Cartridge Details** button, and then click **Cartridge Details**.

---

 **NOTE:** Ink from the cartridges is used in the printing process in a number of different ways, including in the initialization process, which prepares the device and cartridges for printing. In addition, some residual ink is left in the cartridge after it is used. For more information see [www.hp.com/go/inkusage](http://www.hp.com/go/inkusage).

---

## Handle the print cartridges

Before you replace or clean a print cartridge, you should know the part names and how to handle the print cartridges.

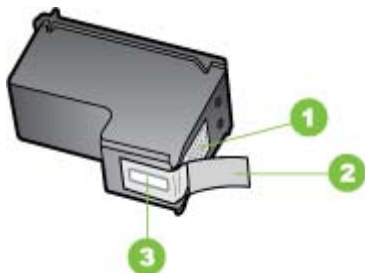

1	Copper-colored contacts
2	Plastic tape with pink pull tab (must be removed before installing)
3	Ink nozzles under tape

Hold the print cartridges by their black plastic sides, with the label on top. Do not touch the copper-colored contacts or the ink nozzles.



---

 **NOTE:** Handle the print cartridges carefully. Dropping or jarring cartridges can cause temporary printing problems, or even permanent damage.

---

## Replace the print cartridges

Follow these instructions when the ink level is low.

---

 **NOTE:** When the ink level for the print cartridge is low, a message appears on the display. You can also check the ink levels by using the **Printer Toolbox** available through the HP Photosmart Software on your computer or through the **Print Properties** dialog box on your computer.

---

When you receive a low-ink warning message on the display, make sure you have a replacement print cartridge available. You should also replace the print cartridges when you see faded text or if you experience print quality issues related to the print cartridges.

To order print cartridges for the device, go to [www.hpshopping.com](http://www.hpshopping.com). If prompted, choose your country/region, follow the prompts to select your product, and then click one of the shopping links on the page.

---

 **TIP:** You can also use these instructions to replace the black print cartridge with a photo print cartridge for printing high-quality color photos.

---

## To replace the print cartridges

1. Make sure the device is on.

---

 **CAUTION:** If the device is off when you open the print cartridge door to access the print cartridges, it will not release the cartridges for changing. You might damage the device if the print cartridges are not docked safely when you try to remove them.

---

2. Open the print cartridge door.  
The print carriage moves to the far right side of the device.



3. Wait until the print carriage is idle and silent, and then lightly press down on a print cartridge to release it.  
If you are replacing the tri-color print cartridge, remove the print cartridge from the slot on the left.

If you are replacing the black or photo print cartridge, remove the print cartridge from the slot on the right.

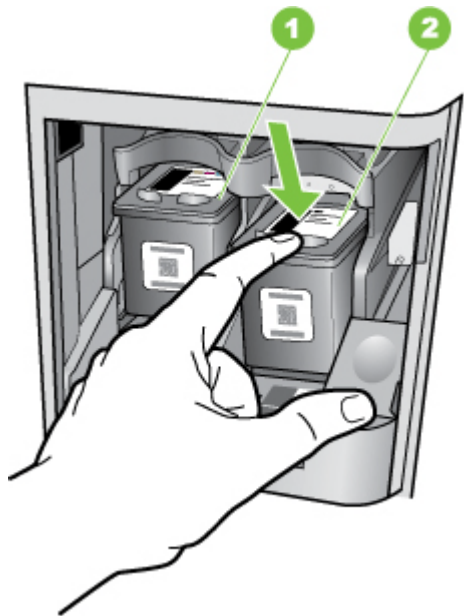

1	Print cartridge slot for the tri-color print cartridge
2	Print cartridge slot for the black and photo print cartridges

4. Pull the print cartridge toward you out of its slot.
5. If you are removing the black print cartridge in order to install the photo print cartridge, store the black print cartridge in the print cartridge protector or an airtight plastic container.

If you are removing the print cartridge because it is low or out of ink, recycle the print cartridge. The HP Inkjet Supplies Recycling Program is available in many countries/regions, and lets you recycle used print cartridges free of charge. For more information, go to the following Web site:

[www.hp.com/hpinfo/globalcitizenship/environment/recycle/inkjet.html](http://www.hp.com/hpinfo/globalcitizenship/environment/recycle/inkjet.html)

6. Remove the new print cartridge from its packaging and, being careful to touch only the black plastic, gently remove the plastic tape by using the pink pull tab.

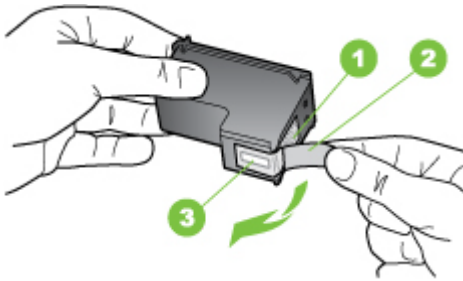

1	Copper-colored contacts
2	Plastic tape with pink pull tab (must be removed before installing)
3	Ink nozzles under tape

**CAUTION:** Do not touch the copper-colored contacts or ink nozzles. Touching these parts can result in clogs, ink failure, and bad electrical connections.



7. Slide the new print cartridge forward into the empty slot. Then gently push on the upper part of the print cartridge forward until it clicks into the socket. If you are installing the tri-color print cartridge, slide it into the left slot.

If you are installing a black or photo print cartridge, slide it into the right slot.

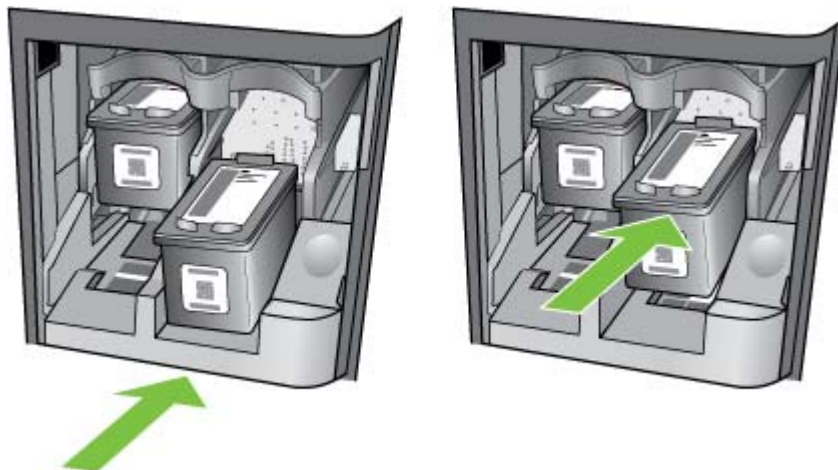

8. Close the print cartridge door.

## Align the print cartridges

The device prompts you to align cartridges every time you install or replace a print cartridge. You can also align the print cartridges at any time from the control panel or by using the software you installed with the device. Aligning the print cartridges ensures high-quality output.

---

 **NOTE:** If you remove and reinstall the same print cartridge, the device will not prompt you to align the print cartridges. It remembers the alignment values for that print cartridge, so you do not need to realign the print cartridges.

---

### To align the print cartridges from the control panel when prompted

1. Make sure you have letter or A4 unused plain white paper loaded in the input tray, and then press **OK**.
2. The device prints a test page and calibrates the printer. Recycle or discard the page.

---

 **NOTE:** If you have colored paper loaded in the input tray when you align the print cartridges, the alignment will fail. Load unused plain white paper into the input tray, and then try the alignment again.

If the alignment fails again, you might have a defective sensor or print cartridge. Contact HP Support. Go to [www.hp.com/support](http://www.hp.com/support). If prompted, choose your country/region, and then click **Contact HP** for information on calling for technical support.

---

### To align the cartridges from the control panel at any time

1. Load letter, A4, or legal unused plain white paper into the input tray.
2. Press **Setup**.
3. Press **6**, then press **2**.  
This selects **Tools** and then selects **Align Print Cartridge**.
4. The device prints a test page and calibrates the printer. Recycle or discard the page.

### To align the print cartridges from the HP Photosmart Software

1. Load letter, A4, or legal unused plain white paper into the input tray.
2. In the HP Solution Center, click **Settings**, point to **Print Settings**, and then click **Printer Toolbox**.



**NOTE:** You can also open the **Printer Toolbox** from the **Print Properties** dialog box. In the **Print Properties** dialog box, click the **Services** tab, and then click **Service this device**.

---

The **Printer Toolbox** appears.

3. Click the **Device Services** tab.
4. Click **Align the Print Cartridges**.  
The device prints a test page and calibrates the printer. Recycle or discard the page.

## Calibrate color

If you are not satisfied with the appearance of colors, you can calibrate the colors manually to ensure the best print quality.



**NOTE:** Calibrate the color only when the tri-color and photo print cartridges are installed together. The photo print cartridge is available for purchase as an optional accessory. For more information, see [HP supplies](#).

---

Color calibration balances color tints on printed pages. It is only necessary if:

- Printed colors have visibly shifted toward yellow, cyan or magenta.
- There is a color tinge in the gray shades.

Low ink levels in the print cartridges might also produce incorrect colors.

**Toolbox:** Open the Toolbox. For more information, see [Toolbox](#). Click the **Printer Services** tab, and then click **Calibrate Color** and follow the onscreen instructions.

## Clean the print cartridges

Use this feature when there is streaking, white lines through any of the lines of color or when a color is muddy after installing a print cartridge for the first time. Do not clean print cartridges unnecessarily, as this wastes ink and shortens the life of the ink nozzles.

### To clean the print cartridges from the control panel

1. Load letter, A4, or legal unused plain white paper into the input tray.
2. Press **Setup**.
3. Press **6**, then press **1**.

This selects **Tools** and then selects **Clean Print Cartridge**.

The device prints a page that you can recycle or discard.

If copy or print quality still seems poor after you clean the print cartridges, try cleaning the print cartridge contacts before replacing the affected print cartridge.

### To clean the print cartridges from the HP Photosmart Software

1. Load letter, A4, or legal unused plain white paper into the input tray.
2. In the HP Solution Center, click **Settings**, point to **Print Settings**, and then click **Printer Toolbox**.



**NOTE:** You can also open the **Printer Toolbox** from the **Print Properties** dialog box. In the **Print Properties** dialog box, click the **Services** tab, and then click **Service this device**.

---

The **Printer Toolbox** appears.

3. Click the **Device Services** tab.
4. Click **Clean the Print Cartridges**.
5. Follow the prompts until you are satisfied with the quality of the output, and then click **Done**.

If copy or print quality still seems poor after you clean the print cartridges, try cleaning the print cartridge contacts before replacing the affected print cartridge.

## Clean the print cartridge contacts

Clean the print cartridge contacts only if you get repeated messages on the display prompting you to check a print cartridge after you already have cleaned or aligned the print cartridges.

Before cleaning the print cartridge contacts, remove the print cartridge and verify that nothing is covering the print cartridge contacts, then reinstall the print cartridge. If you continue to get messages to check the print cartridges, clean the print cartridge contacts.

Make sure you have the following materials available:

- Dry foam rubber swabs, lint-free cloth, or any soft material that will not come apart or leave fibers.



**TIP:** Coffee filters are lint-free and work well for cleaning print cartridges.

---

- Distilled, filtered, or bottled water (tap water might contain contaminants that can damage the print cartridges).



**CAUTION:** Do **not** use platen cleaners or alcohol to clean the print cartridge contacts. These can damage the print cartridge or the HP All-in-One.

---



### To clean the print cartridge contacts

1. Turn on the device and open the print cartridge door.  
The print carriage moves to the far right side of the device.
2. Wait until the print carriage is idle and silent, and then unplug the power cord from the back of the device.

---

 **NOTE:** Depending how long the device is unplugged, the date and time might be erased. You might need to reset the date and time later, when you plug the power cord back in.

---

3. Lightly press down on the print cartridge to release it, and then pull it toward you out of the slot.

---

 **NOTE:** Do not remove both print cartridges at the same time. Remove and clean each print cartridge one at a time. Do not leave a print cartridge outside the device for more than 30 minutes.

---

4. Inspect the print cartridge contacts for ink and debris buildup.
5. Dip a clean foam rubber swab or lint-free cloth into distilled water, and squeeze any excess water from it.
6. Hold the print cartridge by its sides.
7. Clean only the copper-colored contacts. Allow the print cartridges to dry for approximately ten minutes.

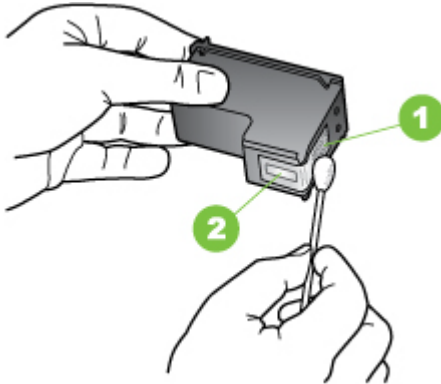

1	Copper-colored contacts
2	Ink nozzles (do not clean)

8. Slide the print cartridge back into the slot. Push the print cartridge forward until it clicks into place.
9. Repeat if necessary for the other print cartridge.
10. Gently close the print cartridge door and plug the power cord into the back of the device.

### Clean the area around the ink nozzles

If the device is used in a dusty environment, a small amount of debris might accumulate inside the device. This debris can include dust, hair, carpet, or clothing fibers. When

debris gets on the print cartridges, it can cause ink streaks and smudges on printed pages. Ink streaking can be corrected by cleaning around the ink nozzles as described here.

---

 **NOTE:** Clean the area around the ink nozzles only if you continue to see streaks and smudges on your printed pages after you have already cleaned the print cartridges by using the control panel or the software you installed with the HP All-in-One.

---

Make sure you have the following materials available:

- Dry foam rubber swabs, lint-free cloth, or any soft material that will not come apart or leave fibers.

---

 **TIP:** Coffee filters are lint-free and work well for cleaning print cartridges.

---

- Distilled, filtered, or bottled water (tap water might contain contaminants that can damage the print cartridges).

---

 **CAUTION:** Do not touch the copper-colored contacts or ink nozzles. Touching these parts can result in clogs, ink failure, and bad electrical connections.

---

### To clean the area around the ink nozzles

1. Turn on the device and open the print cartridge door.  
The print carriage moves to the far right side of the device.
2. Wait until the print carriage is idle and silent, and then unplug the power cord from the back of the device.

---

 **NOTE:** Depending how long the device is unplugged, the date and time might be erased. You might need to reset the date and time later, when you plug the power cord back in.

---

3. Lightly press down on the print cartridge to release it, and then pull it toward you out of the slot.

---

 **NOTE:** Do not remove both print cartridges at the same time. Remove and clean each print cartridge one at a time. Do not leave a print cartridge outside the device for more than 30 minutes.

---

4. Place the print cartridge on a piece of paper with the ink nozzles facing up.
5. Lightly moisten a clean foam rubber swab with distilled water.

6. Clean the face and edges around the ink nozzle area with the swab, as shown below.

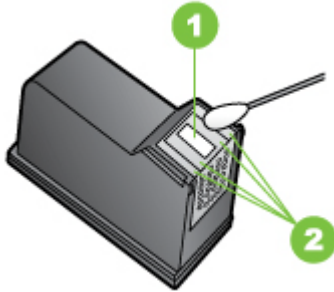

1	Nozzle plate (do not clean)
2	Face and edges around the ink nozzle area

---

**CAUTION:** Do **not** clean the nozzle plate.

---

7. Slide the print cartridge back into the slot. Push the print cartridge forward until it clicks into place.
8. Repeat if necessary for the other print cartridge.
9. Gently close the print cartridge door and plug the power cord into the back of the device.

## Use a photo print cartridge

You can optimize the quality of the color photos you print and copy with the device by purchasing a photo print cartridge. Remove the black print cartridge and insert the photo print cartridge in its place. With the tri-color print cartridge and photo print cartridge installed, you have a six-ink system, which provides enhanced quality color photos.

When you want to print regular text documents, swap the black print cartridge back in. Use a print cartridge protector or an airtight plastic container to keep your print cartridge secure when it is not being used.

---

 **NOTE:** Photo print cartridges are not supported in all countries/regions.

---

## Store printing supplies

This section covers the following topics:

- [Store print cartridges](#)
- [Use the print cartridge protector](#)

### Store print cartridges

Print cartridges can be left in the device for extended periods of time. If you remove the print cartridges, place them in an airtight container, such as a resealable plastic bag.

### Use the print cartridge protector

In some countries/regions, when you purchase a photo print cartridge, you might also receive a print cartridge protector. In other countries/regions, a print cartridge protector

comes in the box with the HP All-in-One. If neither your print cartridge nor the device came with a print cartridge protector, you can use an airtight plastic container to protect your print cartridge.

The print cartridge protector is designed to keep a print cartridge secure and prevent it from drying out when it is not being used. Whenever you remove a print cartridge from the device with the intention of using it again later, store it in the print cartridge protector. For example, store the black print cartridge in a print cartridge protector if you are removing it so you can print high-quality photos with the photo and tri-color print cartridges.

### To insert a print cartridge into the print cartridge protector

- ▲ Place the print cartridge into the print cartridge protector at a slight angle and snap it securely into place.

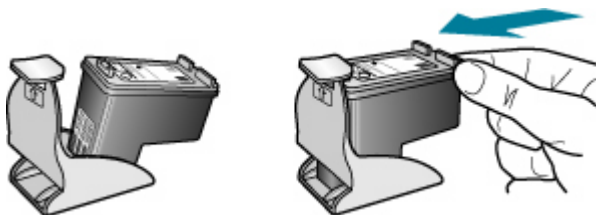

### To remove the print cartridge from the print cartridge protector

- ▲ Press down on the top of the print cartridge protector to release the print cartridge, then gently remove the print cartridge out of the print cartridge protector.

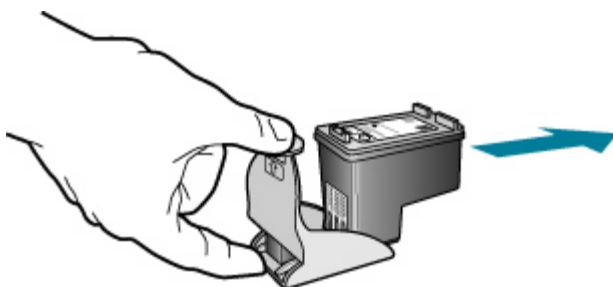

## Clean the device

This section provides instructions for keeping the device in top working condition. Perform these maintenance procedures as necessary.

Dust or dirt on the scanner glass, ADF lid backing, or ADF frame can slow down performance, degrade the quality of scans, and affect the accuracy of special features such as fitting copies to a certain page size.

### Clean the glass

Glass that is dirty from fingerprints, smudges, hair, and dust on the main glass surface slows down performance and affects the accuracy of features such as **Fit to Page**.

In addition to the main glass surface, you might also need to clean the small glass strip inside the automatic document feeder. Streaks can occur if the glass strip inside the automatic document feeder is dirty.

### To clean the glass

1. Turn off the device and raise the lid.
2. Clean the glass with a soft cloth or sponge slightly moistened with a nonabrasive glass cleaner.

---

 **CAUTION:** Do not use abrasives, acetone, benzene, or carbon tetrachloride on the glass, since they can damage it. Do not place or spray liquid directly on the glass. The liquid might seep under the glass and damage the device.

---

3. Dry the glass with a dry, soft, lint-free cloth to prevent spotting.
4. Turn on the device.

## Clean the lid backing

Minor debris can accumulate on the white document backing located underneath the lid of the device.

### To clean the lid backing

1. Turn off the device, unplug the power cord, and raise the lid.

---

 **NOTE:** Depending how long the device is unplugged, the date and time might be erased. You might need to reset the date and time later, when you plug the power cord back in.

---

2. Clean the white document backing with a soft cloth or sponge slightly moistened with a mild soap and warm water.

Wash the backing gently to loosen debris. Do not scrub the backing.

3. Dry the backing with a dry, soft, lint-free cloth.

---

 **CAUTION:** Do not use paper-based wipes, as these might scratch the backing.

---

4. If further cleaning is needed, repeat the previous steps using isopropyl (rubbing) alcohol, and wipe the backing thoroughly with a damp cloth to remove any residual alcohol.

---

 **CAUTION:** Be careful not to spill alcohol on the glass or exterior of the device, as this might damage the device.

---

## Clean the exterior

---

 **NOTE:** Before cleaning the device, turn off the power and unplug the power cord from the electrical socket.

---

Use a soft, damp, lint-free cloth to wipe dust, smudges, and stains off of the case. The exterior of the device does not require cleaning. Keep fluids away from the interior of the device, as well as from the control panel.

## Clean the automatic document feeder

If the automatic document feeder picks up multiple pages or if it does not pick up plain paper, you can clean the rollers and separator pad. Lift the automatic document feeder cover to access the pick assembly inside the automatic document feeder, clean the rollers or separator pad, and then close the cover.

### To clean the rollers or separator pad

1. Remove all originals from the document feeder tray.
2. Lift the automatic document feeder cover (1).  
This provides easy access to the rollers (2) and separator pad (3), as shown below.

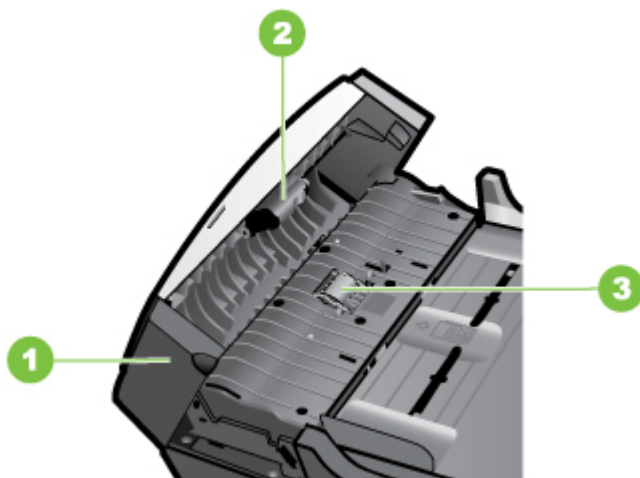

1	Automatic document feeder cover
2	Rollers
3	Separator pad

3. Lightly dampen a clean lint-free cloth with distilled water, then squeeze any excess liquid from the cloth.
4. Use the damp cloth to wipe any residue off the rollers or separator pad.

---

 **NOTE:** If the residue does not come off using distilled water, try using isopropyl (rubbing) alcohol.

---

5. Close the cover of the automatic document feeder.

## To clean the glass strip inside the automatic document feeder

1. Turn off the device and unplug the power cord.

---

 **NOTE:** Depending how long the device is unplugged, the date and time might be erased. You might need to reset the date and time later, when you plug the power cord back in.

---

2. Lift the cover of the automatic document feeder.

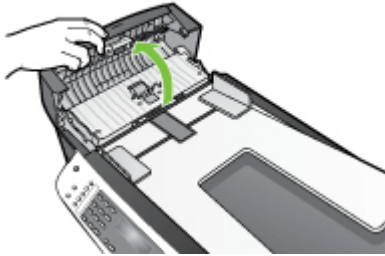

3. Raise the lid, as if you were loading an original on the glass.

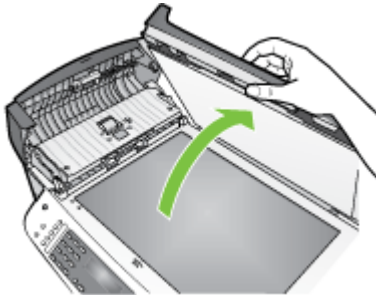

4. Lift the automatic document feeder mechanism.  
There is a glass strip under the automatic document feeder.

5. Clean the glass strip with a soft cloth or sponge slightly moistened with a nonabrasive glass cleaner.



---

△ **CAUTION:** Do not use abrasives, acetone, benzene, or carbon tetrachloride on the glass, since they can damage it. Do not place or spray liquid directly on the glass. The liquid might seep under the glass and damage the device.

---

6. Lower the automatic document feeder mechanism, and then close the cover of the automatic document feeder.
7. Close the lid.
8. Plug in the power cord, and then turn on the device.

## Troubleshooting tips and resources

Use the following tips and resources to resolve printing problems.

- For a paper jam, see [Clear paper jams](#).
- For paper-feed problems, such as the paper skew and paper pick, see [Solve paper-feed problems](#).
- Power light is on and not blinking. When the device is turned on for the first time, it takes approximately 12 minutes to initialize it after the print cartridges are installed.
- Power cord and other cables are working, and are firmly connected to the device. Make sure the device is connected firmly to a functioning alternating current (AC) power outlet, and is turned on.
- Media is loaded correctly in the tray and is not jammed in the device.
- The rear access panel is locked into place.
- All packing tapes and materials are removed.
- The device is set as the current or default printer in the Printers folder. See your computer's documentation for more information.
- **Pause Printing** is not selected if you are using a computer running Windows.
- You are not running too many programs when you are performing a task. Close programs that you are not using or restart the computer before attempting the task again.



# Solve printing problems

- [The device shuts down unexpectedly](#)
- [Error message appears on control-panel display](#)
- [The device is not responding \(nothing prints\)](#)
- [Device takes a long time to print](#)
- [Blank or partial page printed](#)
- [Something on the page is missing or incorrect](#)
- [Placement of the text or graphics is wrong](#)

## The device shuts down unexpectedly

### Check the power and power connections

Make sure the device is connected firmly to a functioning alternating current (AC) power outlet.

## Error message appears on control-panel display

### A non-recoverable error has occurred

Disconnect all cables (such as power cord, network cable, and USB cable), wait about 20 seconds, and reconnect the cables. If the problem persists, visit the HP Web site ([www.hp.com/support](http://www.hp.com/support)) for the latest troubleshooting information, or product fixes and updates.

## The device is not responding (nothing prints)

### Print jobs are stuck in the print queue

Open the print queue, cancel all documents, and then reboot the computer. After the system reboots, try printing again. For information on clearing the print queue, see the help for the operating system.

### Check the device setup

For more information, see [Troubleshooting tips and resources](#).

### Check the device software installation

If the device is turned off when printing, an alert message should appear on your computer screen; otherwise, the device software might not be installed correctly. To resolve this, uninstall the software completely, and then reinstall the device software. For more information, see [Uninstall and reinstall the software](#).

### Check the cable connections

Make sure both ends of the USB cable are secure.

### Check any personal firewall software installed on the computer

The personal software firewall is a security program that protects a computer from intrusion. However, the firewall might block communication between the computer and

the device. If there is a problem communicating with the device, try temporarily disabling the firewall. If the problem persists, the firewall is not the source of the communication problem. Re-enable the firewall.

## Device takes a long time to print

### Check the system configuration

Make sure the computer meets the minimum system requirements for the device. For more information, see [System requirements](#).

### Check the device software settings

Print speed is slower when **Best** or **Maximum dpi** is selected as the print quality. To increase the print speed, select different print settings in the device driver. For more information, see [Change print settings](#).

## Blank or partial page printed

### Clean the print cartridge

Complete the print cartridge cleaning procedure. For more information, see [Work with print cartridges](#).

### Check the media settings

- Make sure you select the correct print quality settings in the printer driver for the media loaded in the trays.
- Make sure the page settings in the printer driver match the page size of media loaded in the tray.

### More than one page is being picked

For more information on paper-feed problems, see [Solve paper-feed problems](#).

### There is a blank page in the file

Check the file to make sure there is no blank page.

## Something on the page is missing or incorrect

### Check the print cartridges

Make sure the correct print cartridges are installed and the print cartridges are not low on ink. For more information, see [Manage the device](#) and [Supported print cartridges](#).

### Check the margin settings

Make sure the margin settings for the document do not exceed the printable area of the device. For more information, see [Set minimum margins](#).

### Check the color print settings

Make sure **Print in Grayscale** is not selected in the print driver.

### **Check the device location and length of USB cable**

High electromagnetic fields (such as those generated by USB cables) can sometimes cause slight distortions to printouts. Move the device away from the source of the electromagnetic fields. Also, it is recommended that you use a USB cable that is less than 3 meters (9.8 feet) long to minimize the effects of these electromagnetic fields.

## **Placement of the text or graphics is wrong**

### **Check how the media is loaded**

Make sure the media width and length guides fit snugly against the edges of the stack of media, and make sure the trays are not overloaded. For more information, see [Load media](#).

### **Check the media size**

- Content on a page might be cut off if the document size is larger than the media that you are using.
- Make sure the media size selected in the printer driver match the size of media loaded in the tray.

### **Check the margin settings**

If the text or graphics are cut off at the edges of the page, make sure the margin settings for the document do not exceed the printable area of your device. For more information, see [Set minimum margins](#).

### **Check the page-orientation setting**

Make sure the media size and page orientation selected in the application match the settings in the printer driver. For more information, see [Change print settings](#).

### **Check the device location and length of USB cable**

High electromagnetic fields (such as those generated by USB cables) can sometimes cause slight distortions to printouts. Move the device away from the source of the electromagnetic fields. Also, it is recommended that you use a USB cable that is less than 3 meters (9.8 feet) long to minimize the effects of these electromagnetic fields.

If the above solutions do not work, the problem may be caused by the inability of the application to interpret print settings properly. See the release notes for known software conflicts, refer to the application's documentation, or contact the software manufacturer for specific help.

## **Poor print quality and unexpected printouts**

- [Poor quality printouts](#)
- [Meaningless characters print](#)
- [Ink is smearing](#)
- [Ink is not filling the text or graphics completely](#)
- [Output is faded or dull colored](#)
- [Colors are printing as black and white](#)

- [Wrong colors are printing](#)
- [Printout shows bleeding colors](#)
- [Colors do not line up properly](#)
- [Lines or dots are missing from text or graphics](#)

## Poor quality printouts

### Check the print cartridges

Make sure the correct print cartridges are installed and the print cartridges are not low on ink. For more information, see [Manage the device](#) and [Supported print cartridges](#).

### Check the paper quality

The paper might be too moist or too rough. Make sure the media meets HP specifications, and try to print again. For more information, see [Select print media](#).

### Check the type of media loaded in the device

- Make sure the tray supports the type of media you have loaded. For more information, see [Understand specifications for supported media](#).
- Make sure you have selected the tray in the print driver that contains the media that you want to use.

### Check the device location and length of USB cable

High electromagnetic fields (such as those generated by USB cables) can sometimes cause slight distortions to printouts. Move the device away from the source of the electromagnetic fields. Also, it is recommended that you use a USB cable that is less than 3 meters (9.8 feet) long to minimize the effects of these electromagnetic fields.

## Meaningless characters print

If an interruption occurs to a job that is printing, the device might not recognize the rest of the job.

Cancel the print job and wait for the device to return to the ready state. If the device does not return to the ready state, cancel all jobs and wait again. When the device is ready, resend the job. If prompted by the computer to retry the job, click **Cancel**.

### Check the cable connections

If the device and computer are connected with a USB cable, the problem may be due to a poor cable connection.

Make sure the cable connections at both ends are secure. If the problem persists, turn off the device, disconnect the cable from the device, turn on the device without connecting the cable, and delete any remaining jobs from the print spooler. When the Power light is on and not flashing, reconnect the cable.

### Check the document file

The document file may be damaged. If you can print other documents from the same application, try printing a backup copy of your document, if available.

## Ink is smearing

### Check the print settings

- When you print documents that use a lot of ink, allow more time to dry before handling the printouts. This is especially true for transparencies. In the printer driver, select the **Best** print quality, and also increase the ink drying time and reduce the ink saturation using the ink volume under the advanced features. However, note that decreasing ink saturation might give printouts a "washed-out" quality.
- Color documents that have rich, blended colors can wrinkle or smear when printed using the **Best** print quality. Try using another print mode, such as **Normal**, to reduce ink, or use HP Premium Paper designed for printing vivid color documents. For more information, see [Change print settings](#).

### Check the media type

Some types of media do not accept ink well. For these types of media, ink will dry more slowly and smearing may occur. For more information, see [Select print media](#).

## Ink is not filling the text or graphics completely

### Check the media type

Some media types are not suitable for use with the device. For more information, see [Select print media](#).

### Check the print cartridges

Make sure the print cartridges are not low on ink. For more information, see [Manage the device](#).

## Output is faded or dull colored

### Check the print mode

The **Fast** mode in the printer driver allows you to print at a faster rate, which is good for printing drafts. To get better results, select **Normal** or **Best**. For more information, see [Change print settings](#).

### Check the paper type setting

When printing on transparencies or other special media, select the corresponding media type in the print driver. For more information, see [Print on special and custom-sized media](#).

## Colors are printing as black and white

### Check the print settings

Make sure **Print in Grayscale** is not selected in the printer driver. For more information, see [Change print settings](#).

## Wrong colors are printing

### Check the print settings

Make sure **Print in Grayscale** is not selected in the printer driver. For more information, see [Change print settings](#).

### Check the print cartridges

Make sure the correct print cartridges are installed and the print cartridges are not low on ink. For more information, see [Manage the device](#) and [Supported print cartridges](#).

## Printout shows bleeding colors

### Check the print cartridges

Make sure print cartridges have not been tampered with. Refilling processes and the use of incompatible inks can disrupt the intricate printing system and result in reduced print quality and damage to the device. HP does not guarantee or support refilled print cartridges. For ordering information, see [HP supplies](#).

## Colors do not line up properly

### Check the print cartridges

Make sure the correct print cartridges are installed and the print cartridges are not low on ink. For more information, see [Manage the device](#) and [Supported print cartridges](#).

### Check the graphics placement

Use the zoom or print preview feature of your software to check for gaps in the placement of graphics on the page.

## Lines or dots are missing from text or graphics

### Check the print cartridges

Make sure the print cartridges are not low on ink. For more information, see [Manage the device](#).

## Solve paper-feed problems

For information on resolving jams, see [Clear paper jams](#).

## Media is not supported for the printer or tray

Use only media that is supported for the device and the tray being used. For more information, see [Understand specifications for supported media](#).

### **Media is not picked up from a tray**

- Make sure media is loaded in the tray. For more information, see [Load media](#). Fan the media before loading.
- Make sure the paper guides are set to the correct markings in the tray for the media size you are loading. Also make sure the guides are snug, but not tight, against the stack.
- Make sure media in the tray is not curled. Uncurl paper by bending it in the opposite direction of the curl.

### **Media is not coming out correctly**

- Make sure the output tray extension is extended; otherwise, printed pages may fall off the device.



- Remove excess media from the output tray. There is a limit to the number of sheets the tray can hold.

### **Pages are skewing**

- Make sure the media loaded in the trays is aligned to the paper guides. If needed, pull out the trays from the device and reload the media properly, making sure that the paper guides are properly aligned.
- Load media into the device only when it is not printing.

### **Multiple pages are being picked up**

- Fan the media before loading.
- Make sure the paper guides are set to the correct markings in the tray for the media size you are loading. Also make sure the guides are snug, but not tight, against the stack.
- Make sure the tray is not overloaded with paper.
- Use HP media for optimum performance and efficiency.

## Solve copy problems

If the following topics do not help, see [Support and warranty](#) for information about HP support.

### No copy came out

- **Check the power**  
Make sure that the power cord is securely connected, and the device turned on.
- **Check the status of the device**
  - The device might be busy with another job. Check the control-panel display for information about the status of jobs. Wait for any job that is processing to finish.
  - The device might be jammed. Check for jams. See [Clear paper jams](#).
- **Check the trays**  
Make sure that media is loaded. See [Load media](#) for more information.

### Copies are blank

- **Check the trays**
  - If you are copying from the ADF, make sure that the originals have been loaded correctly. For more information, see [Load an original in the automatic document feeder \(ADF\)](#).
  - If you are copying from the scanner glass, make sure that the ADF is empty.
- **Check the media**  
The media might not meet Hewlett-Packard media specifications (for example, the media is too moist or too rough). See [Select print media](#) for more information.
- **Check the settings**  
The contrast setting might be set too light. Use the **Copy** button on the control panel to create darker copies.

### Wrong original was copied

#### Check the trays

If you are copying from the scanner glass, make sure that the ADF is empty.

### Documents are missing or faded

- **Check the media**  
The media might not meet Hewlett-Packard media specifications (for example, the media is too moist or too rough). See [Select print media](#) for more information.
- **Check the settings**  
The quality setting of **Fast** (which produces draft-quality copies) might be responsible for the missing or faded documents. Change to the **Normal** or **Best** setting.
- **Check the original**
  - The accuracy of the copy depends on the quality and size of the original. Use the **Copy** menu to adjust the brightness of the copy. If the original is too light, the copy might not be able to compensate, even if you adjust the contrast.
  - Colored backgrounds might cause images in the foreground to blend into the background, or the background might appear in a different shade.



## Size is reduced

- The reduce/enlarge or other copy feature might have been set from the control panel to reduce the scanned image. Check the settings for the copy job to make sure that they are for normal size.
- The HP photo and imaging software settings might be set to reduce the scanned image. Change the settings, if needed. See the onscreen Help for the HP photo and imaging software for more information.

## Copy quality is poor

- **Take steps to improve the copy quality**
  - Use quality originals.
  - Load the media correctly. If the media is loaded incorrectly, it might skew, causing unclear images. See [Load media](#) for more information.
  - Use or make a carrier sheet to protect your originals.
- **Check the device**
  - The ADF might not be closed properly.
  - The scanner glass, ADF lid backing, or ADF window might need cleaning. See [Clean the device](#) for more information.

## Copy defects are apparent

- **Vertical white or faded stripes**

The media might not meet Hewlett-Packard media specifications (for example, the media is too moist or too rough). See [Select print media](#) for more information.
- **Too light or dark**

Try adjusting the contrast and copy-quality settings.
- **Unwanted lines**

The scanner glass, ADF lid backing, or ADF frame might need cleaning. See [Clean the device](#) for more information.
- **Black dots or streaks**

Ink, glue, correction fluid, or an unwanted substance might be on the scanner glass or ADF lid backing. Try cleaning the device. See [Clean the device](#) for more information.
- **Unclear text**
  - Try adjusting the contrast and copy-quality settings.
  - The default enhancement setting might not be suitable for the job. Check the setting and change it to enhance text or photographs, if needed. For more information, see [Change the copy settings](#).
- **Incompletely filled text or graphics**

Try adjusting the contrast and copy-quality settings.
- Copy is slanted or skewed
  - Make sure that the ADF input tray is not too full.
  - Make sure that the ADF width adjusters are snug against the sides of the media.

- **Large, black typefaces look splotchy (not smooth)**  
The default enhancement setting might not be suitable for the job. Check the setting and change it to enhance text or photographs, if needed. For more information, see [Change the copy settings](#).
- **Horizontal grainy or white bands in light-gray to medium-gray areas**  
The default enhancement setting might not be suitable for the job. Check the setting and change it to enhance text or photographs, if needed. For more information, see [Change the copy settings](#).

## Error messages appear

### “Reload document and then reload job”

Press the **OK** button, and then reload the remaining documents (up to 25 pages) in the ADF. For more information see [Load originals](#).

## Solve scan problems

If the following topics do not help, see [Support and warranty](#) for information about HP support.



**NOTE:** If you are starting the scan from a computer, see the software Help for troubleshooting information.

---

## Scanner did nothing

- **Check the original**  
Make sure that the original is loaded correctly. For more information, see [Load an original on the scanner glass](#).
- **Check the device**  
The device might be coming out of PowerSave mode after a period of inactivity, which delays processing a short while. Wait until the device reaches the **READY** state.

## Scan takes too long

- **Check the settings**
  - If you set the resolution too high, the scan job takes longer and results in larger files. To obtain good results when scanning or copying, do not use a resolution that is higher than needed. You can lower the resolution to scan more quickly.
  - If you acquire an image through TWAIN, you can change the settings so that the original scans in black and white. See the onscreen Help for the TWAIN program for information.
- **Check the status of the device**  
If you sent a print or copy job before you tried to scan, the scan starts if the scanner is not busy. However, the printing and scanning processes share memory, which means that the scan might be slower.

## Part of the document did not scan or text is missing

- **Check the original**
  - Make sure that you loaded the original correctly. For more information, see [Load originals](#).
  - If you scanned the document from the ADF, try scanning the document directly from the scanner glass. For more information, see [Load an original on the scanner glass](#).
  - Colored backgrounds can cause images in the foreground to blend into the background. Try adjusting the settings before you scan the original, or try enhancing the image after you scan the original.
- **Check the settings**
  - Make sure that the input media size is large enough for the original that you are scanning.
  - If you are using the HP photo and imaging software, the default settings in the HP photo and imaging software might be set to automatically perform a specific task other than the one that you are attempting. See the onscreen Help for the HP photo and imaging software for instructions about changing the properties.

## Text cannot be edited

- **Check the settings**
  - Make sure that the OCR software is set to edit text.
  - When you scan the original, make sure that you select a document type that creates editable text. If text is classified as a graphic, it is not converted to text.
  - Your OCR program might be linked to a word-processing program that does not perform OCR tasks. See the product software Help for more information about linking programs.
- **Check the originals**
  - For OCR, the original must be loaded into the ADF with the top forward and face-up. Make sure that you loaded the original correctly. For more information, see [Load originals](#).
  - The OCR program might not recognize text that is tightly spaced. For example, if the text that the OCR program converts has missing or combined characters, "rn" might appear as "m."
  - The accuracy of the OCR program depends on the image quality, text size, and structure of the original and the quality of the scan itself. Make sure that your original has good image quality.
  - Colored backgrounds can cause images in the foreground to blend too much. Try adjusting the settings before you scan the original, or try enhancing the image after you scan the original. If you are performing an OCR operation on an original, any colored text on the original does not scan well, if at all.

## Error messages appear

- **"Unable to activate TWAIN source" or "An error occurred while acquiring the image"**
  - If you are acquiring an image from another device, such as a digital camera or another scanner, make sure that the other device is TWAIN-compliant. Devices that are not TWAIN-compliant do not work with the device software.
  - Make sure that you have connected the USB cable to the correct port on the back of your computer.
  - Verify that the correct TWAIN source is selected. In the software, check the TWAIN source by selecting **Select Scanner** on the **File** menu.
- **"Reload document and then restart job"**

Press the **OK** button, and then reload the remaining documents (up to 50 pages) in the ADF. For more information see [Load originals](#).

## Scanned image quality is poor

### The original is a second-generation photo or picture

Reprinted photographs, such as those in newspapers or magazines, are printed by using tiny dots of ink that make an interpretation of the original photograph, which degrades the quality. Often, the ink dots form unwanted patterns that can be detected when the image is scanned or printed or when the image appears on a screen. If the following suggestions do not solve the problem, you might need to use a better-quality version of the original.

- To eliminate the patterns, try reducing the size of the image after scanning.
- Print the scanned image to see if the quality is better.
- Make sure that the resolution and color settings are correct for the type of scan job.
- For best results, use the flatbed scanner for scanning rather than the ADF.

### Text or images on the back of a two-sided original appear in the scan

Two-sided originals can "bleed" text or images from the back side to the scan if the originals are printed on media that is too thin or too transparent.

### The image quality is better when printed

The image that appears on the screen is not always an accurate representation of the quality of the scan.

- Try adjusting your computer monitor settings to use more colors (or levels of gray). On Windows computers, you typically make this adjustment by opening **Display** on the Windows control panel.
- Try adjusting the resolution and color settings.
- **The scanned image is skewed (crooked)**

The original might have been loaded incorrectly. Be sure to use the media guides when you load the originals into the ADF. For more information, see [Load originals](#).
- **The scanned image shows blots, lines, vertical white stripes, or other defects**
  - If the scanner glass is dirty, the image produced does not have optimum clarity. See [Clean the device](#) for cleaning instructions.
  - The defects might be on the original and not a result of the scanning process.

- **Graphics look different from the original**  
The graphics settings might not be suitable for the type of scan job that you are performing. Try changing the graphics settings.
- **Take steps to improve the scan quality**
  - Use the glass to scan rather than the ADF.
  - Use high-quality originals.
  - Load the media correctly. If the media is loaded incorrectly, it might skew, which causes unclear images. For more information, see [Load originals](#).
  - Adjust the software settings according to how you plan to use the scanned page.
  - Use or make a carrier sheet to protect your originals.
  - Clean the scanner glass. See [Clean the glass](#) for more information.

## Scan defects are apparent

- **Blank pages**
  - The original might have been loaded upside down. Make sure that you loaded the original correctly. For more information, see [Load originals](#).
  - If you are producing blank pages when you scan from the glass, make sure that the original document is loaded correctly. Place the original document face down on the flatbed scanner with the top-left corner of the document located in the lower-right corner of the scanner glass. Also, make sure that the ADF is empty.
- **Too light or dark**
  - Try adjusting the settings. Be sure to use the correct resolution and color settings.
  - The original image might be very light or dark or might be printed on colored paper.
- **Unwanted lines**  
Ink, glue, correction fluid, or an unwanted substance might be on the scanner glass. Try cleaning the scanner glass. See [Clean the device](#) for more information.
- **Black dots or streaks**
  - Ink, glue, correction fluid, or an unwanted substance might be on the scanner glass, the scanner glass might be dirty or scratched, or the ADF lid backing might be dirty. Try cleaning the scanner glass and lid backing. See [Clean the device](#) for more information. If cleaning does not correct the problem, the scanner glass or ADF lid backing might need to be replaced.
  - The defects might be on the original and not a result of the scanning process.
- **Unclear text**  
Try adjusting the settings. Make sure that the resolution and color settings are correct.
- **Size is reduced**  
The HP software settings might be set to reduce the scanned image. See the product software Help for more information about changing the settings.

## Solve fax problems

This section contains fax setup troubleshooting information for the device. If the device is not set up properly for faxing, you might experience problems when sending faxes, receiving faxes, or both.

If you are having faxing problems, you can print a fax test report to check the status of the device. The test will fail if the device is not set up properly for faxing. Perform this test after you have completed setting up the device for faxing. For more information, see [Test fax setup](#).

If the test fails, review the report for information on how to fix any problems found. For more information, see [The fax test failed](#).

## The fax test failed

If you ran a fax test and the test failed, review the report for basic information about the error. For more detailed information, check the report to see which part of the test failed, and then review the appropriate topic in this section for solutions to try.

- [The "Fax Hardware Test" failed](#)
- [The "Fax Connected to Active Telephone Wall Jack" test failed](#)
- [The "Phone Cord Connected to Correct Port on Fax" test failed](#)
- [The "Using Correct Type of Phone Cord with Fax" test failed](#)
- [The "Dial Tone Detection" test failed](#)
- [The "Fax Line Condition" test failed](#)

### The "Fax Hardware Test" failed

#### Solution:

- Turn off the device by using the **Power** button located on the control panel and then unplug the power cord from the back of the device. After a few seconds, plug the power cord in again, and then turn the power on. Run the test again. If the test fails again, continue reviewing the troubleshooting information in this section.
- Try to send or receive a test fax. If you can send or receive a fax successfully, there might not be a problem.
- If you are running the test from the **Fax Setup Wizard**, make sure the device is not busy completing another task, such as receiving a fax or making a copy. Check the display for a message indicating that the device is busy. If it is busy, wait until it is finished and in the idle state before running the test.
- Make sure you use the phone cord that came with the device. If you do not use the supplied phone cord to connect from the telephone wall jack to the device, you might not be able to send or receive faxes. After you plug in the phone cord that came with the device, run the fax test again.
- If you are using a phone splitter, this can cause faxing problems. (A splitter is a two-cord connector that plugs into a telephone wall jack.) Try removing the splitter and connecting the device directly to the telephone wall jack.

After you resolve any problems found, run the fax test again to make sure it passes and the device is ready for faxing. If the **Fax Hardware Test** continues to fail and you experience problems faxing, contact HP Support. Go to [www.hp.com/support](http://www.hp.com/support). If prompted, choose your country/region, and then click **Contact HP** for information on calling for technical support.

## The "Fax Connected to Active Telephone Wall Jack" test failed

### Solution:

- Check the connection between the telephone wall jack and the device to make sure the phone cord is secure.
- Make sure you use the phone cord that came with the device. If you do not use the supplied phone cord to connect from the telephone wall jack to the device, you might not be able to send or receive faxes. After you plug in the phone cord that came with the device, run the fax test again.
- Make sure you have correctly connected the device to the telephone wall jack. Using the phone cord supplied in the box with the device, connect one end to your telephone wall jack, then connect the other end to the port labeled 1-LINE on the back of the device. For more information on setting up the device for faxing, see [Set up faxing for the device](#).
- If you are using a phone splitter, this can cause faxing problems. (A splitter is a two-cord connector that plugs into a telephone wall jack.) Try removing the splitter and connecting the device directly to the telephone wall jack.
- Try connecting a working phone and phone cord to the telephone wall jack that you are using for the device and check for a dial tone. If you do not hear a dial tone, contact your telephone company and have them check the line.
- Try to send or receive a test fax. If you can send or receive a fax successfully, there might not be a problem.

After you resolve any problems found, run the fax test again to make sure it passes and the device is ready for faxing.

---

## The "Phone Cord Connected to Correct Port on Fax" test failed

**Solution:** Plug the phone cord into the correct port.

1. Using the phone cord supplied in the box with the device, connect one end to your telephone wall jack, then connect the other end to the port labeled 1-LINE on the back of the device.



**NOTE:** If you use the 2-EXT port to connect to the telephone wall jack, you will not be able to send or receive faxes. The 2-EXT port should only be used to connect other equipment, such as an answering machine or a telephone.

---

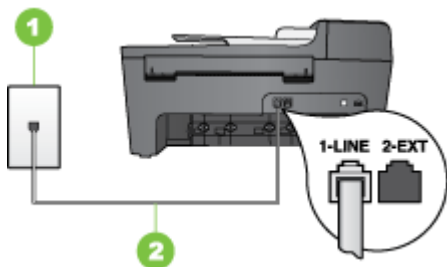

**Figure 8-1 Back view of the device**

1	Telephone wall jack
2	Use the phone cord supplied in the box with the device to connect to the "1-LINE" port

2. After you have connected the phone cord to the port labeled 1-LINE, run the fax test again to make sure it passes and the device is ready for faxing.
3. Try to send or receive a test fax.
  - Make sure you use the phone cord that came with the device. If you do not use the supplied phone cord to connect from the telephone wall jack to the device, you might not be able to send or receive faxes. After you plug in the phone cord that came with the device, run the fax test again.
  - If you are using a phone splitter, this can cause faxing problems. (A splitter is a two-cord connector that plugs into a telephone wall jack.) Try removing the splitter and connecting the device directly to the telephone wall jack.

### The "Using Correct Type of Phone Cord with Fax" test failed

#### Solution:

- Make sure you used the phone cord supplied in the box with the device to connect to the telephone wall jack. One end of the phone cord should be connected to the port labeled 1-LINE on the back of the device, and the other end to your telephone wall jack, as shown below.

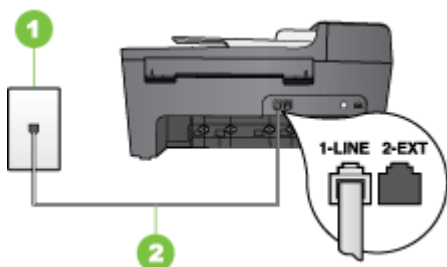

1	Telephone wall jack
2	Use the phone cord supplied in the box with the device to connect to the "1-LINE" port



If the phone cord that came with the device is not long enough, you can use a coupler to extend the length. You can purchase a coupler at an electronics store that carries phone accessories. You will also need another phone cord, which can be a standard phone cord that you might already have in your home or office.

- Check the connection between the telephone wall jack and the device to make sure the phone cord is secure.
  - Make sure you use the phone cord that came with the device. If you do not use the supplied phone cord to connect from the telephone wall jack to the device, you might not be able to send or receive faxes. After you plug in the phone cord that came with the device, run the fax test again.
  - If you are using a phone splitter, this can cause faxing problems. (A splitter is a two-cord connector that plugs into a telephone wall jack.) Try removing the splitter and connecting the device directly to the telephone wall jack.
- 

### The "Dial Tone Detection" test failed

#### **Solution:**

- Other equipment, which uses the same phone line as the device, might be causing the test to fail. To find out if other equipment is causing a problem, disconnect everything from the phone line, and then run the test again. If the **Dial Tone Detection Test** passes without the other equipment, then one or more pieces of the equipment is causing problems; try adding them back one at a time and rerunning the test each time, until you identify which piece of equipment is causing the problem.
- Try connecting a working phone and phone cord to the telephone wall jack that you are using for the device and check for a dial tone. If you do not hear a dial tone, contact your telephone company and have them check the line.
- Make sure you have correctly connected the device to the telephone wall jack. Using the phone cord supplied in the box with the device, connect one end to your telephone wall jack, then connect the other end to the port labeled 1-LINE on the back of the device.
- If you are using a phone splitter, this can cause faxing problems. (A splitter is a two-cord connector that plugs into a telephone wall jack.) Try removing the splitter and connecting the device directly to the telephone wall jack.
- If your telephone system is not using a standard dial tone, such as some PBX systems, this might cause the test to fail. This will not cause a problem sending or receiving faxes. Try sending or receiving a test fax.
- Check to make sure the country/region setting is set appropriately for your country/region. If the country/region setting is not set or is set incorrectly, the test might fail and you might have problems sending and receiving faxes.

- Make sure you connect the device to an analog phone line or you will not be able to send or receive faxes. To check if your phone line is digital, connect a regular analog phone to the line and listen for a dial tone. If you do not hear a normal sounding dial tone, it might be a phone line set up for digital phones. Connect the device to an analog phone line and try sending or receiving a fax.
- Make sure you use the phone cord that came with the device. If you do not use the supplied phone cord to connect from the telephone wall jack to the device, you might not be able to send or receive faxes. After you plug in the phone cord that came with the device, run the fax test again.

After you resolve any problems found, run the fax test again to make sure it passes and the device is ready for faxing. If the **Dial Tone Detection** test continues to fail, contact your telephone company and have them check the phone line.

---

### The "Fax Line Condition" test failed

#### **Solution:**

- Make sure you connect the device to an analog phone line or you will not be able to send or receive faxes. To check if your phone line is digital, connect a regular analog phone to the line and listen for a dial tone. If you do not hear a normal sounding dial tone, it might be a phone line set up for digital phones. Connect the device to an analog phone line and try sending or receiving a fax.
- Check the connection between the telephone wall jack and the device to make sure the phone cord is secure.
- Make sure you have correctly connected the device to the telephone wall jack. Using the phone cord supplied in the box with the device, connect one end to your telephone wall jack, then connect the other end to the port labeled 1-LINE on the back of the device.
- Other equipment, which uses the same phone line as the device, might be causing the test to fail. To find out if other equipment is causing a problem, disconnect everything from the phone line, and then run the test again.
  - If the **Fax Line Condition Test** passes without the other equipment, then one or more pieces of the equipment is causing problems; try adding them back one at a time and rerunning the test each time, until you identify which piece of equipment is causing the problem.
  - If the **Fax Line Condition Test** fails without the other equipment, connect the device to a working phone line and continue reviewing the troubleshooting information in this section.
- If you are using a phone splitter, this can cause faxing problems. (A splitter is a two-cord connector that plugs into a telephone wall jack.) Try removing the splitter and connecting the device directly to the telephone wall jack.
- Make sure you use the phone cord that came with the device. If you do not use the supplied phone cord to connect from the telephone wall jack to the device, you might not be able to send or receive faxes. After you plug in the phone cord that came with the device, run the fax test again.

After you resolve any problems found, run the fax test again to make sure it passes and the device is ready for faxing. If the **Fax Line Condition** test continues to fail and

you experience problems faxing, contact your telephone company and have them check the phone line.

---

### The display always shows Phone Off Hook

**Solution:** You are using the wrong type of phone cord. Make sure you are using the phone cord that came with the device to connect the device to your phone line. If the phone cord that came with the device is not long enough, you can use a coupler to extend the length. You can purchase a coupler at an electronics store that carries phone accessories. You will also need another phone cord, which can be a standard phone cord that you might already have in your home or office.

---

**Solution:** Other equipment that uses the same phone line as the device might be in use. Make sure extension phones (phones on the same phone line, but not connected to the device) or other equipment are not in use or off the hook. For example, you cannot use the device for faxing if an extension phone is off the hook, or if you are using a computer dial-up modem to send e-mail or access the Internet.

---

### The device is having problems sending and receiving faxes

**Solution:** Make sure the device is turned on. Look at the display on the device. If the display is blank and the **Power** light is not lit, the device is turned off. Make sure the power cord is firmly connected to the device and plugged into a power outlet. Press the **Power** button to turn on the device.

After turning on the device, HP recommends you wait five minutes before sending or receiving a fax. The device cannot send or receive faxes while it is initializing after being turned on.

---

### Solution:

- Make sure you used the phone cord supplied in the box with the device to connect to the telephone wall jack. One end of the phone cord should be connected to the port labeled 1-LINE on the back of the device and the other end to your telephone wall jack, as shown below.

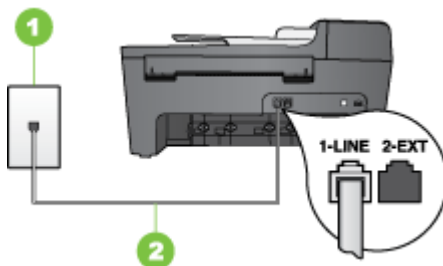

---

1	Telephone wall jack
2	Use the phone cord supplied in the box with the device to connect to the "1-LINE" port

---

If the phone cord that came with the device is not long enough, you can use a coupler to extend the length. You can purchase a coupler at an electronics store that carries phone accessories. You will also need another phone cord, which can be a standard phone cord that you might already have in your home or office.

- Try connecting a working phone and phone cord to the telephone wall jack that you are using for the device and check for a dial tone. If you do not hear a dial tone, call your local telephone company for service.
- Other equipment, which uses the same phone line as the device, might be in use. For example, you cannot use the device for faxing if an extension phone is off the hook, or if you are using a computer dial-up modem to send an e-mail or access the Internet.
- Check to see if another process has caused an error. Check the display or your computer for an error message providing information about the problem and how to solve it. If there is an error, the device will not send or receive a fax until the error condition is resolved.
- The phone line connection might be noisy. Phone lines with poor sound quality (noise) can cause faxing problems. Check the sound quality of the phone line by plugging a phone into the telephone wall jack and listening for static or other noise. If you hear noise, turn **Error Correction Mode (ECM)** off and try faxing again. For information about changing ECM, see the onscreen Help. If the problem persists, contact your telephone company.
- If you are using a digital subscriber line (DSL) service, make sure that you have a DSL filter connected or you will not be able to fax successfully. For more information, see [Case B: Set up the device with DSL](#).
- Make sure the device is not connected to a telephone wall jack that is set up for digital phones. To check if your phone line is digital, connect a regular analog phone to the line and listen for a dial tone. If you do not hear a normal sounding dial tone, it might be a phone line set up for digital phones.
- If you are using either a private branch exchange (PBX) or an integrated services digital network (ISDN) converter/terminal adapter, make sure the device is connected to the correct port and the terminal adapter is set to the correct switch type for your country/region, if possible. For more information, see [Case C: Set up the device with a PBX phone system or an ISDN line](#).

- If the device shares the same phone line with a DSL service, the DSL modem might not be properly grounded. If the DSL modem is not properly grounded, it can create noise on the phone line. Phone lines with poor sound quality (noise) can cause faxing problems. You can check the sound quality of the phone line by plugging a phone into the telephone wall jack and listening for static or other noise. If you hear noise, turn off your DSL modem and completely remove power for at least 15 minutes. Turn the DSL modem back on and listen to the dial tone again.

 **NOTE:** You might notice static on the phone line again in the future. If the device stops sending and receiving faxes, repeat this process.

If the phone line is still noisy, contact your telephone company. For information on turning your DSL modem off, contact your DSL provider for support.

- If you are using a phone splitter, this can cause faxing problems. (A splitter is a two-cord connector that plugs into a telephone wall jack.) Try removing the splitter and connecting the device directly to the telephone wall jack.

## The device is having problems sending a manual fax

### Solution:

 **NOTE:** This possible solution applies only in the countries/regions that receive a 2-wire phone cord in the box with the device, including: Argentina, Australia, Brazil, Canada, Chile, China, Colombia, Greece, India, Indonesia, Ireland, Japan, Korea, Latin America, Malaysia, Mexico, Philippines, Poland, Portugal, Russia, Saudi Arabia, Singapore, Spain, Taiwan, Thailand, USA, Venezuela, and Vietnam.

- Make sure the telephone you use to initiate the fax call is connected directly to the device. To send a fax manually, the telephone must be connected directly to the port labeled 2-EXT on the device, as shown below.

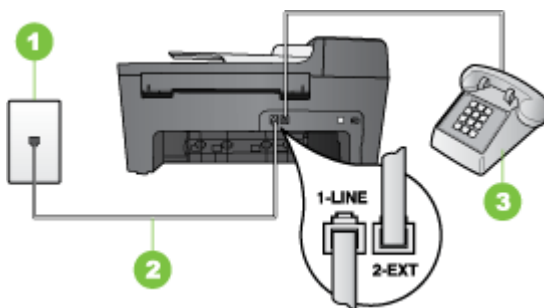

1	Telephone wall jack
2	Use the phone cord supplied in the box with the device to connect to the "1-LINE" port
3	Telephone

- If you are sending a fax manually from your phone that is connected directly to the device, you must use the keypad on the telephone to send the fax. You cannot use the keypad on the control panel of the device.

---

 **NOTE:** If using a serial-type phone system, please connect your phone directly on top of the device cable which has a wall plug attached to it.

---

### The device cannot receive faxes, but can send faxes

#### Solution:

- If you are not using a distinctive ring service, check to make sure that the **Distinctive Ring** feature on the device is set to **All Rings**. For more information, see [Change the answer ring pattern for distinctive ring](#).
- If **Auto Answer** is set to **Off**, you will need to receive faxes manually; otherwise, the device will not receive the fax. For information on receiving faxes manually, see [Receive a fax manually](#).
- If you have a voice mail service at the same phone number you use for fax calls, you must receive faxes manually, not automatically. This means that you must be available to respond in person to incoming fax calls. For information on setting up the device when you have a voice mail service, see [Case F: Shared voice/fax line with voice mail](#). For information on receiving faxes manually, see [Receive a fax manually](#).
- If you have a computer dial-up modem on the same phone line with the device, check to make sure that the software that came with your modem is not set to receive faxes automatically. Modems that are set up to receive faxes automatically take over the phone line to receive all incoming faxes, which prevents the device from receiving fax calls.
- If you have an answering machine on the same phone line with the device, you might have one of the following problems:
  - Your answering machine might not be set up properly with the device.
  - Your outgoing message might be too long or too loud to allow the device to detect fax tones, and the sending fax machine might disconnect.
  - Your answering machine might not have enough quiet time after your outgoing message to allow the device to detect fax tones. This problem is most common with digital answering machines.

The following actions might help solve these problems:

- When you have an answering machine on the same phone line you use for fax calls, try connecting the answering machine directly to the device as described in [Case I: Shared voice/fax line with answering machine](#).
- Make sure the device is set to receive faxes automatically. For information on setting up the device to receive faxes automatically, see [Receive a fax](#).
- Make sure the **Rings to Answer** setting is set to a greater number of rings than the answering machine. For more information, see [Set the number of rings before answering](#).

- Disconnect the answering machine and then try receiving a fax. If faxing is successful without the answering machine, the answering machine might be causing the problem.
- Reconnect the answering machine and record your outgoing message again. Record a message that is approximately 10 seconds in duration. Speak slowly and at a low volume when recording your message. Leave at least 5 seconds of silence at the end of the voice message. There should be no background noise when recording this silent time. Try to receive a fax again.



**NOTE:** Some digital answering machines might not retain the recorded silence at the end of your outgoing message. Play back your outgoing message to check.

- If the device shares the same phone line with other types of phone equipment, such as an answering machine, a computer dial-up modem, or a multi-port switch box, the fax signal level might be reduced. The signal level can also be reduced if you use a splitter or connect extra cables to extend the length of your phone. A reduced fax signal can cause problems during fax reception.  
To find out if other equipment is causing a problem, disconnect everything except the device from the phone line, and then try to receive a fax. If you can receive faxes successfully without the other equipment, one or more pieces of the other equipment is causing problems; try adding them back one at a time and receiving a fax each time, until you identify which equipment is causing the problem.
- If you have a special ring pattern for your fax phone number (using a distinctive ring service through your telephone company), make sure that the **Distinctive Ring** feature on the device is set to match. For more information, see [Change the answer ring pattern for distinctive ring](#).

---

## The device cannot send faxes, but can receive faxes

### Solution:

- The device might be dialing too fast or too soon. You might need to insert some pauses in the number sequence. For example, if you need to access an outside line before dialing the phone number, insert a pause following the access number. If your number is 95555555, and 9 accesses an outside line, you might insert pauses as follows: 9-555-5555. To enter a pause in the fax number you are typing, press **Redial/Pause**, or press the **Space (#)** button repeatedly, until a dash (-) appears on the display.  
You can also send the fax using monitor dialing. This enables you to listen to the phone line as you dial. You can set the pace of your dialing and respond to prompts as you dial. For more information, see [Send a fax using monitor dialing](#).
- The number you entered when sending the fax is not in the proper format or the receiving fax machine is having problems. To check this, try calling the fax number from a telephone and listen for fax tones. If you cannot hear fax tones, the receiving fax machine might not be turned on or connected, or a voice mail service could be interfering with the recipient's phone line. You can also ask the recipient to check the receiving fax machine for any problems.

## Fax tones are recorded on my answering machine

### Solution:

- When you have an answering machine on the same phone line you use for fax calls, try connecting the answering machine directly to the device as described in [Case I: Shared voice/fax line with answering machine](#). If you do not connect the answering machine as recommended, fax tones might be recorded on your answering machine.
  - Make sure the device is set to receive faxes automatically and that the **Rings to Answer** setting is correct. The number of rings to answer for the device should be greater than the number of rings to answer for the answering machine. If the answering machine and the device are set to the same number of rings to answer, both devices answer the call and fax tones are recorded on the answering machine.
  - Set your answering machine to a low number of rings and the device to answer in the maximum number of rings supported. (The maximum number of rings varies by country/region.) In this setup, the answering machine answers the call and the device monitors the line. If the device detects fax tones, the device receives the fax. If the call is a voice call, the answering machine records the incoming message. For more information, see [Set the number of rings before answering](#).
- 

## The phone cord that came with my device is not long enough

**Solution:** If the phone cord that came with the device is not long enough, you can use a coupler to extend the length. You can purchase a coupler at an electronics store that carries phone accessories. You will also need another phone cord, which can be a standard phone cord that you might already have in your home or office.

 **TIP:** If the device came with a 2-wire phone cord adaptor, you can use it with a 4-wire phone cord to extend the length. For information on using the 2-wire phone cord adaptor, see the documentation that came with it.

---

### To extend your phone cord

1. Using the phone cord supplied in the box with the device, connect one end to the coupler, then connect the other end to the port labeled 1-LINE on the back of the device.
  2. Connect another phone cord to the open port on the coupler and to the telephone wall jack.
- 

## Troubleshoot installation issues

If the following topics do not help, see [Support and warranty](#) for information about HP support.

- [Hardware installation suggestions](#)
- [Software installation suggestions](#)



## Hardware installation suggestions

### Check the device

- Make sure that all packing tape and material have been removed from outside and inside the device.
- Make sure that the device is loaded with paper.
- Make sure that no lights are on or blinking except the Ready light, which should be on. If the Attention light is blinking, check for messages on the control panel.

### Check the hardware connections

- Make sure that any cords and cables that you are using are in good working order.
- Make sure that the power cord is connected securely to both the device and to a working power outlet.
- Make sure that the phone cord is connected to the 1-LINE port.

### Check the print cartridges

- Make sure that you have removed the tape from the print cartridges.
- Make sure that the print cartridges are firmly installed in their correct slot. Press down firmly on each one to ensure proper contact.

### Check the device to ensure the following:

- Power light is on and not blinking. When the device is first turned on, it takes approximately 45 seconds to warm up.
- The device is in the Ready state, and no other lights on the control panel are lit or blinking. If lights are lit or blinking, see the message on the control panel.
- Ensure power cord and other cables are working, and are firmly connected to the device.
- All packing tapes and materials are removed from the device.
- Rear access panel is locked into place.
- Paper is loaded correctly in the tray, and is not jammed in the device.
- Ensure the tape is removed from each print cartridge.
- Print cartridges are properly installed in their correct slots. Press down firmly on each one to ensure proper contact.

## Software installation suggestions

### Check the computer system

- Make sure that your computer is running one of the supported operating systems.
- Make sure that the computer meets at least the minimum system requirements.

### Verify installation preliminaries

- Make sure to use the Starter CD that contains the correct installation software for your operating system.
- Before installing software, make sure that all other programs are closed.

- If the computer does not recognize the path to the CD-ROM drive that you type, make sure that you are specifying the correct drive letter.
- If the computer cannot recognize the Starter CD in the CD-ROM drive, inspect the Starter CD for damage. You can download the device driver from the HP Web site ([www.hp.com/support](http://www.hp.com/support)).

**Check or perform the following:**

- Make sure the computer meets the system requirements.
- Before installing software, ensure all other programs are closed.
- If the computer does not recognize the path to the CD drive that you typed, ensure you are specifying the correct drive letter.
- If the computer cannot recognize the Starter CD in the CD drive, inspect the CD for damage. You can download the device driver from the HP Web site ([www.hp.com/support](http://www.hp.com/support)).
- In the Windows device manager, make sure that the USB drivers have not been disabled.
- If the computer cannot detect the device, run the uninstallation utility (util\ccc\uninstall.bat on the Starter CD) to perform a clean uninstallation of the device driver. Restart your computer, and reinstall the device driver.

## Clear paper jams

If the paper was loaded in the input tray, you might need to clear the paper jam from the rear door.

Paper can also jam in the automatic document feeder. Several common actions can cause paper to jam the automatic document feeder:

- Placing too much paper in the document feeder tray. For information on the maximum number of sheets allowed in the automatic document feeder, see [Load originals](#).
- Using paper that is too thick or too thin for the device.
- Trying to add paper to the document feeder tray while the device is feeding pages.

### To clear a paper jam from the rear door

1. Press in the tab on the left side of the rear door to release the door. Remove the door by pulling it away from the device.

---

△ **CAUTION:** Trying to clear a paper jam from the front of the device can damage the print mechanism. Always access and clear paper jams through the rear door.

---

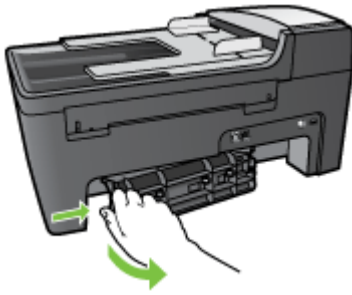

2. Gently pull the paper out of the rollers.

---

△ **CAUTION:** If the paper tears when you are removing it from the rollers, check the rollers and wheels for torn pieces of paper that might be remaining inside the device. If you do not remove all the pieces of paper from the device, more paper jams are likely to occur.

---

3. Replace the rear door. Gently push the door forward until it snaps into place.
4. Press **OK** to continue the current job.

#### **To clear a paper jam in the automatic document feeder**

1. Lift the cover of the automatic document feeder.

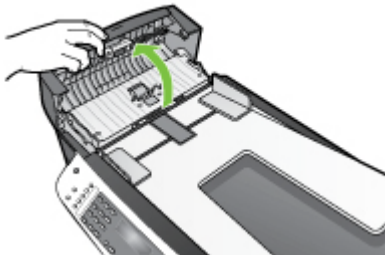

2. Gently pull the paper out of the rollers.

---

△ **CAUTION:** If the paper tears when you are removing it from the rollers, check the rollers and wheels for torn pieces of paper that might be remaining inside the device. If you do not remove all the pieces of paper from the device, more paper jams are likely to occur.

---

3. Close the cover of the automatic document feeder.

## **Avoid paper jams**

To help avoid paper jams, follow these guidelines.

- Remove printed papers from the output tray frequently.
- Prevent curled or wrinkled paper by storing all unused paper flat in a resealable bag.
- Ensure that paper loaded in the input tray lays flat and the edges are not bent or torn.
- Do not combine different paper types and paper sizes in the input tray; the entire stack of paper in the input tray must be the same size and type.
- Adjust the paper-width guide in the input tray to fit snugly against all paper. Make sure the paper-width guide does not bend the paper in the input tray.
- Do not force paper too far forward in the input tray.
- Use paper types that are recommended for the device. For more information, see [Understand specifications for supported media](#).
- Do not leave originals on the glass. If you load an original in the automatic document feeder while there is already an original on the glass, the original can jam in the automatic document feeder.

---

# A HP supplies

This section provides information on HP supplies for the device. The information is subject to change; visit the HP Web site ([www.hpshopping.com](http://www.hpshopping.com)) for the latest updates. You may also make purchases through the Web site.

- [Order printing supplies online](#)
- [Supplies](#)

## Order printing supplies online

To order genuine HP supplies for the device, go to [www.hpshopping.com](http://www.hpshopping.com). If prompted, choose your country/region, follow the prompts to select your product, and then click one of the shopping links on the page.

Besides the HP Web site, you may order printing supplies using the following tool:

**Toolbox:** On the **Estimated Ink Level** tab, click **Shop Online**.

## Supplies

- [Print cartridges](#)
- [HP media](#)

### Print cartridges

Use only the replacement cartridges that have the same cartridge number as the print cartridge you are replacing. You can find the cartridge number in the following places:

- On the label of the print cartridge you are replacing.
- **Toolbox:** Click the **Estimated Ink Level** tab, and then click the **Cartridge Details** button to view information about replacement print cartridges.

---

 **NOTE:** Ordering print cartridges online is not supported in all countries/regions. If it is not supported in your country/region, contact a local HP reseller for information about purchasing print cartridges.

If you live in Europe, go to [www.hp.com/eu/hard-to-find-supplies](http://www.hp.com/eu/hard-to-find-supplies) to locate information on HP print cartridges.

---

### HP media

To order media such as HP Premium Plus Photo Paper or HP Premium Paper, go to [www.hpshopping.com](http://www.hpshopping.com).

---

# B Support and warranty

The information in [Maintain and troubleshoot](#) suggests solutions to common problems. If your device is not operating correctly and those suggestions did not solve your problem, try using one of the following support services to obtain assistance.

This section contains the following topics:

- [Hewlett-Packard limited warranty statement](#)
- [Obtain electronic support](#)
- [Obtain HP telephone support](#)
- [Prepare the device for shipment](#)
- [Pack the device](#)

# Hewlett-Packard limited warranty statement

HP product	Duration of limited warranty
Software Media	90 days
Printer	1 year
Print or Ink cartridges	Until the HP ink is depleted or the "end of warranty" date printed on the cartridge has been reached, whichever occurs first. This warranty does not cover HP ink products that have been refilled, remanufactured, refurbished, misused, or tampered with.
Accessories	1 year unless otherwise stated

## A. Extent of limited warranty

1. Hewlett-Packard (HP) warrants to the end-user customer that the HP products specified above will be free from defects in materials and workmanship for the duration specified above, which duration begins on the date of purchase by the customer.
2. For software products, HP's limited warranty applies only to a failure to execute programming instructions. HP does not warrant that the operation of any product will be interrupted or error free.
3. HP's limited warranty covers only those defects that arise as a result of normal use of the product, and does not cover any other problems, including those that arise as a result of:
  - a. Improper maintenance or modification;
  - b. Software, media, parts, or supplies not provided or supported by HP;
  - c. Operation outside the product's specifications;
  - d. Unauthorized modification or misuse.
4. For HP printer products, the use of a non-HP cartridge or a refilled cartridge does not affect either the warranty to the customer or any HP support contract with the customer. However, if printer failure or damage is attributable to the use of a non-HP or refilled cartridge or an expired ink cartridge, HP will charge its standard time and materials charges to service the printer for the particular failure or damage.
5. If HP receives, during the applicable warranty period, notice of a defect in any product which is covered by HP's warranty, HP shall either repair or replace the product, at HP's option.
6. If HP is unable to repair or replace, as applicable, a defective product which is covered by HP's warranty, HP shall, within a reasonable time after being notified of the defect, refund the purchase price for the product.
7. HP shall have no obligation to repair, replace, or refund until the customer returns the defective product to HP.
8. Any replacement product may be either new or like-new, provided that it has functionality at least equal to that of the product being replaced.
9. HP products may contain remanufactured parts, components, or materials equivalent to new in performance.
10. HP's Limited Warranty Statement is valid in any country where the covered HP product is distributed by HP. Contracts for additional warranty services, such as on-site service, may be available from any authorized HP service facility in countries where the product is distributed by HP or by an authorized importer.

## B. Limitations of warranty

TO THE EXTENT ALLOWED BY LOCAL LAW, NEITHER HP NOR ITS THIRD PARTY SUPPLIERS MAKES ANY OTHER WARRANTY OR CONDITION OF ANY KIND, WHETHER EXPRESS OR IMPLIED WARRANTIES OR CONDITIONS OF MERCHANTABILITY, SATISFACTORY QUALITY, AND FITNESS FOR A PARTICULAR PURPOSE.

## C. Limitations of liability

1. To the extent allowed by local law, the remedies provided in this Warranty Statement are the customer's sole and exclusive remedies.
2. TO THE EXTENT ALLOWED BY LOCAL LAW, EXCEPT FOR THE OBLIGATIONS SPECIFICALLY SET FORTH IN THIS WARRANTY STATEMENT, IN NO EVENT SHALL HP OR ITS THIRD PARTY SUPPLIERS BE LIABLE FOR DIRECT, INDIRECT, SPECIAL, INCIDENTAL, OR CONSEQUENTIAL DAMAGES, WHETHER BASED ON CONTRACT, TORT, OR ANY OTHER LEGAL THEORY AND WHETHER ADVISED OF THE POSSIBILITY OF SUCH DAMAGES.

## D. Local law

1. This Warranty Statement gives the customer specific legal rights. The customer may also have other rights which vary from state to state in the United States, from province to province in Canada, and from country to country elsewhere in the world.
2. To the extent that this Warranty Statement is inconsistent with local law, this Warranty Statement shall be deemed modified to be consistent with such local law. Under such local law, certain disclaimers and limitations of this Warranty Statement may not apply to the customer. For example, some states in the United States, as well as some governments outside the United States (including provinces in Canada), may:
  - a. Preclude the disclaimers and limitations in this Warranty Statement from limiting the statutory rights of a consumer (e.g., the United Kingdom);
  - b. Otherwise restrict the ability of a manufacturer to enforce such disclaimers or limitations; or
  - c. Grant the customer additional warranty rights, specify the duration of implied warranties which the manufacturer cannot disclaim, or allow limitations on the duration of implied warranties.
3. THE TERMS IN THIS WARRANTY STATEMENT, EXCEPT TO THE EXTENT LAWFULLY PERMITTED, DO NOT EXCLUDE, RESTRICT, OR MODIFY, AND ARE IN ADDITION TO, THE MANDATORY STATUTORY RIGHTS APPLICABLE TO THE SALE OF THE HP PRODUCTS TO SUCH CUSTOMERS.

### HP Limited Warranty

Dear Customer,

You will find below the name and address of the HP entity responsible for the performance of the HP Limited Warranty in your country.

**You may have additional statutory rights against the seller based on your purchase agreement. Those rights are not in any way affected by this HP Limited Warranty.**

**Ireland:** Hewlett-Packard Ireland Ltd, 30 Herbert Street IRL-Dublin 2

**United Kingdom:** Hewlett-Packard Ltd, Cain Road, Bracknell, GB-Berks RG12 1HN

## Obtain electronic support

To find support and warranty information, go to the HP Web site at [www.hp.com/support](http://www.hp.com/support). If prompted, choose your country/region, and then click **Contact HP** for information on calling for technical support.

This Web site also offers technical support, drivers, supplies, ordering information and other options such as:

- Access online support pages.
- Send HP an e-mail message for answers to your questions.
- Connect with an HP technician by using online chat.
- Check for software updates.

You can also obtain support from the Toolbox. The Toolbox provides easy, step-by-step solutions to common printing problems. For more information, see [Toolbox](#).

Support options and availability vary by product, country/region, and language.

## Obtain HP telephone support

During the warranty period, you may obtain assistance from the HP Customer Care Center.

This section contains the following topics:

- [Before you call](#)
- [Support process](#)
- [HP support by phone](#)
- [Additional warranty options](#)

### Before you call

Visit the HP Web site ([www.hp.com/support](http://www.hp.com/support)) for the latest troubleshooting information, or product fixes and updates.

To assist our Customer Care Center representatives to serve you better, prepare the following information if you need to call HP.

1. If the device does not print, get the following information ready:
  - Device model
  - Model number and serial number (check the back of the device)
2. Check the operating system that you are using, such as Windows XP.
3. Note how the device is connected to your system, such as through a USB connection.
4. Obtain the version number of the printer software. (To find the version number of the printer driver, open the printer settings or properties dialog box, and click the **About** tab.)
5. If you have a problem printing from a particular application, note the application and version number.

### Support process

**If you have a problem, follow these steps:**

1. Check the documentation that came with the device.
2. Visit the HP online support Web site at [www.hp.com/support](http://www.hp.com/support). HP online support is available to all HP customers. It is the fastest source for up-to-date device information and expert assistance and includes the following features:
  - Fast access to qualified online support specialists
  - Software and driver updates for the device



- Valuable troubleshooting information for common problems
  - Proactive updates, support alerts, and HP newsletters that are available when you register the device
3. Call HP support. Support options and availability vary by device, country/region, and language.

## **HP support by phone**

This section contains the following topics:

- [Phone support period](#)
- [Telephone support numbers](#)
- [Placing a call](#)
- [After the phone support period](#)

### **Phone support period**

One year of phone support is available in North America, Asia Pacific, and Latin America (including Mexico). For the most current list of telephone support numbers, go to [www.hp.com/support](http://www.hp.com/support).

### **Telephone support numbers**

In many locations, HP provides toll free telephone support during the warranty period. However, some of the support numbers listed below may not be toll free.

For the most current list of telephone support numbers, see [www.hp.com/support](http://www.hp.com/support).



021 672 280	الجزائر
Argentina (Buenos Aires)	54-11-4708-1600
Argentina	0-800-555-5000
Australia	1300 721 147
Australia (out-of-warranty)	1902 910 910
Österreich	0820 87 4417
17212049	البحرين
België	070 300 005
Belgique	070 300 004
Brasil (Sao Paulo)	55-11-4004-7751
Brasil	0-800-709-7751
Canada	1-(800)-474-6836 (1-800 hp invent)
Central America & The Caribbean	<a href="http://www.hp.com/support">www.hp.com/support</a>
Chile	800-360-999
中国	10-68687980
中国	800-810-3888
Colombia (Bogotá)	571-606-9191
Colombia	01-8000-51-4746-8368
Costa Rica	0-800-011-1046
Česká republika	810 222 222
Danmark	70 202 845
Ecuador (Andinetel)	1-999-119 ☎ 800-711-2884
Ecuador (Pacifitel)	1-800-225-528 ☎ 800-711-2884
(02) 6910602	مصر
El Salvador	800-6160
España	902 010 059
France	0892 69 60 22
Deutschland	01805 652 180
Ελλάδα (από το εξωτερικό)	+ 30 210 6073603
Ελλάδα (εντός Ελλάδας)	801 11 75400
Ελλάδα (από Κύπρο)	800 9 2654
Guatemala	1-800-711-2884
香港特別行政區	(852) 2802 4098
Magyarország	06 40 200 629
India	1-800-425-7737
India	91-80-28526900
Indonesia	+62 (21) 350 3408
+971 4 224 9189	العراق
+971 4 224 9189	الكويت
+971 4 224 9189	لبنان
+971 4 224 9189	قطر
+971 4 224 9189	اليمن
Ireland	1890 923 902
1-700-503-048	ישראל
Italia	848 800 871
Jamaica	1-800-711-2884
日本	0570-000511
日本(携帯電話の場合)	03-3335-9800

0800 222 47	الأردن
한국	1588-3003
Luxembourg (Français)	900 40 006
Luxembourg (Deutsch)	900 40 007
Malaysia	1800 88 8588
Mauritius	(262) 262 210 404
México (Ciudad de México)	55-5258-9922
México	01-800-472-68368
081 005 010	المغرب
Nederland	0900 2020 165
New Zealand	0800 441 147
Nigeria	(01) 271 2320
Norge	815 62 070
24791773	عمان
Panamá	1-800-711-2884
Paraguay	009 800 54 1 0006
Perú	0-800-10111
Philippines	2 867 3551
Polska	801 800 235
Portugal	808 201 492
Puerto Rico	1-877-232-0589
República Dominicana	1-800-711-2884
Reunion	0820 890 323
România	0801 033 390
Россия (Москва)	095 777 3284
Россия (Санкт-Петербург)	812 332 4240
800 897 1415	السعودية
Singapore	6 272 5300
Slovensko	0850 111 256
All other African English Speaking ISE countries	+ 27 (0)11 234 5872
South Africa (RSA)	0860 104 771
Rest of West Africa	+ 351 213 17 63 80
Suomi	0 203 66 767
Sverige	077 120 4765
Switzerland	0848 672 672
臺灣	02-8722-8000
ไทย	+66 (2) 353 9000
071 891 391	تونس
Trinidad & Tobago	1-800-711-2884
Türkiye	+90 212 444 71 71
Україна	(044) 230 51 06
600 54 47 47	المتحدة العربية الإمارات
United Kingdom	0870 010 4320
United States	1-(800)-474-6836
Uruguay	0004-054-177
Venezuela (Caracas)	58-212-278-8666
Venezuela	0-800-474-68368
Viet Nam	+84 88234530

## Placing a call

Call HP support while you are in front of the computer and the HP All-in-One. Be prepared to provide the following information:

- Model number (located on the label on the front of the device)
- Serial number (located on the back or bottom of the device)
- Messages that appear when the situation occurs
- Answers to these questions:
  - Has this situation happened before?
  - Can you re-create it?
  - Did you add any new hardware or software to your computer at about the time that this situation began?
  - Did anything else occur prior to this situation (such as a thunderstorm, HP All-in-One was moved, etc.)?

## After the phone support period

After the phone support period, help is available from HP at an additional cost. Help may also be available at the HP online support Web site: [www.hp.com/support](http://www.hp.com/support). Contact your HP dealer or call the support phone number for your country/region to learn more about support options.

## Additional warranty options

Extended service plans are available for the device at additional costs. Go to [www.hp.com/support](http://www.hp.com/support), select your country/region and language, then explore the services and warranty area for information about the extended service plans.

## Prepare the device for shipment

If after contacting HP Customer Support or returning to the point of purchase, you are requested to send the device in for service, make sure you remove and keep the following items before returning your device:

- The print cartridges
- The control-panel faceplate
- The power cord, USB cable, and any other cable connected to the device
- Any paper loaded in the input tray
- Remove any originals you might have loaded in the device

This section contains the following topics:

- [Remove the print cartridges before shipment](#)
- [Remove the control-panel faceplate](#)

## Remove the print cartridges before shipment

Before you return the device, make sure you remove the print cartridges.

**To remove print cartridges before shipment**

1. Turn on the device and wait until the print carriage is idle and silent. If the device will not turn on, skip this step and go to step 2.

---

 **NOTE:** If the device does not turn on, you can unplug the power cord and then manually slide the print carriage to the far right side to remove the print cartridges.

---

2. Gently pull open the print cartridge cover.



3. Remove the print cartridges from their slots by grasping each between your thumb and forefinger and pulling it firmly toward you.

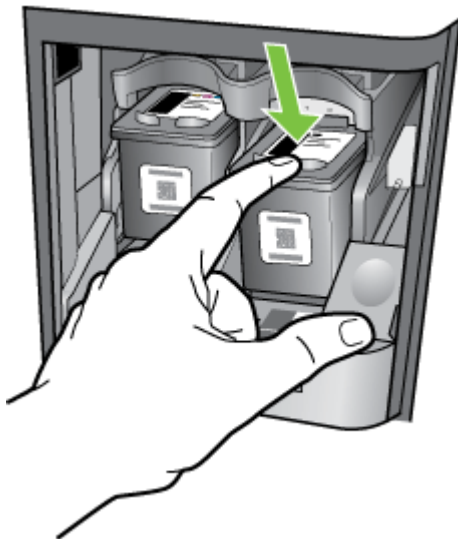

4. Place the print cartridges in an airtight plastic container so they will not dry out, and put them aside. Do not send them with the device unless the HP customer support call agent instructs you to.

5. Close the print cartridge door and wait a few minutes for the print carriage to move back to its home position (on the left side).
6. After the scanner is idle and has returned to its parked position, press the **Power** button to turn off the device.

### Remove the control-panel faceplate

Complete the following steps once you have removed the print cartridges.

---

△ **CAUTION:** The device must be unplugged before following these steps.

**CAUTION:** The replacement device will not be shipped with a power cord. Store the power cord in a safe place until the replacement arrives.

---

#### To remove the control-panel faceplate

1. Press the **Power** button to turn off the device.
2. Unplug the power cord, and then disconnect it from the device. Do not return the power cord with the device.
3. Remove the control-panel faceplate as follows:
  - a. Lift the ADF lid.

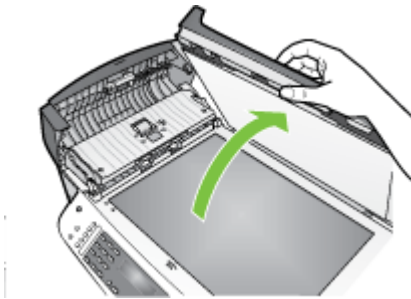

- b. Use either your finger or insert a thin object in the tab on the upper right corner of the control-panel faceplate to pry the control-panel faceplate off.



4. Retain the control-panel faceplate. Do not return the control-panel faceplate with the device.

**△ CAUTION:** The replacement device might not come with a control-panel faceplate. Store your control-panel faceplate in a safe place, and when the replacement device arrives, reattach your control-panel faceplate. You must attach your control-panel faceplate to use the control-panel functions on the replacement device.

**📝 NOTE:** See the setup poster that came with the device for instructions on how to attach your control-panel faceplate. The replacement device might come with instructions for setting up your device.

## Pack the device

Complete the following steps after you have prepared the device for shipment.

### To pack the device

1. If available, pack the device for shipment by using the original packaging materials, or use the packaging materials that came with your replacement device.

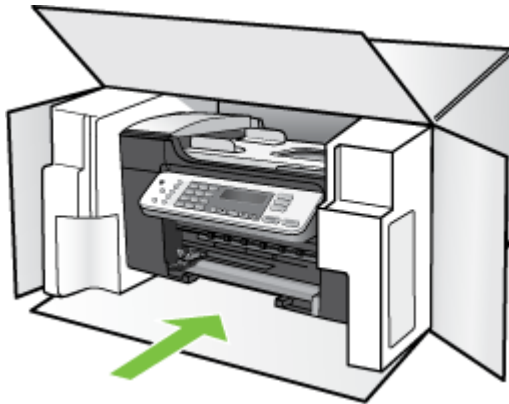

If you do not have the original packaging materials, please use other adequate packaging materials. Shipping damage caused by improper packaging and/or improper transportation is not covered under the warranty.

2. Place the return shipping label on the outside of the box.
3. Include the following items in the box:
  - A complete description of symptoms for service personnel (samples of print quality problems are helpful).
  - A copy of the sales slip or other proof of purchase to establish the warranty coverage period.
  - Your name, address, and a phone number where you can be reached during the day.

# C Device specifications

For media and media-handling specifications, see [Understand specifications for supported media](#).

This section contains the following topics:

- [Physical specifications](#)
- [Product features and capacities](#)
- [Memory specifications](#)
- [System requirements](#)
- [Print specifications](#)
- [Copy specifications](#)
- [Fax specifications](#)
- [Scan specifications](#)
- [Environmental specifications](#)
- [Electrical specifications](#)
- [Acoustic emission specifications \(noise levels per ISO 7779\)](#)

## Physical specifications

- Height: 235 mm (9.25 inches)
- Width: 435 mm (17.13 inches)
- Depth: 418 mm (16.46 inches)
- Weight: 5.9 kg (13 pounds)

## Product features and capacities

Feature	Capacity
Connectivity	<ul style="list-style-type: none"><li>• USB 2.0-compliant high speed</li><li>• USB host connector is only supported up to full speed.</li></ul>
Print cartridges	Three print cartridges (black, tri-color, photo) <b>NOTE:</b> Not all print cartridges are supported in all countries/regions.
Supply yields	Visit <a href="http://www.hp.com/pageyield/">www.hp.com/pageyield/</a> for more information on estimated print cartridge yields.
Device languages	HP PCL 3 enhanced
Font support	US fonts: CG Times, CG Times Italic, Universe, Universe Italic, Courier, Courier Italic, Letter Gothic, Letter Gothic Italic.
Duty cycle	Up to 1,000 pages per month

## Memory specifications

2 MB ROM, 16 MB RAM

## System requirements

---



**NOTE:** For the most current information about supported operating systems and system requirements, visit <http://www.hp.com/support/>.

---

### Operating system compatibility

- Windows 2000, Windows XP, Windows XP x64, Windows Vista
- 



**NOTE:** For Windows 2000, only printer drivers, scanner drivers, and the Toolbox are available.

---

- Linux

### Minimum requirements

- Windows 2000 Service Pack 4: Intel Pentium II or Celeron processor, 128 MB RAM, 160 MB free hard disk space, Microsoft Internet Explorer 6.0
- Windows XP (32-bit): Intel Pentium II or Celeron processor, 128 MB RAM, 340 MB free hard space, Microsoft Internet Explorer 6.0
- Microsoft® Windows® x64: AMD Athlon 64, AMD Opteron, Intel Xeon processor with Intel EM64T support, or Intel Pentium 4 processor with Intel EM64T support, 128 MB RAM, 300 MB free hard disk space, Microsoft Internet Explorer 6.0
- Windows Vista: 800 MHz 32-bit (x86) or 64-bit (x64) processor, 512 MB RAM, 740 MB free hard disk space, Microsoft Internet Explorer 7.0
- Adobe Acrobat Reader 5.0 or later

### Recommended requirements

- Windows 2000 Service Pack 4: Intel Pentium III or higher processor, 200 MB RAM, 160 MB free hard disk space
- Windows XP (32-bit): Intel Pentium III or higher processor, 256 MB RAM, 370 MB free hard disk space
- Microsoft® Windows® XP x64: AMD Athlon 64, AMD Opteron, Intel Xeon processor with Intel EM64T support, or Intel Pentium 4 processor with Intel EM64T support, 256 MB RAM, 340 MB free hard disk space
- Windows Vista: 1 GHz 32-bit (x86) or 64-bit (x64) processor, 1 GB RAM, 1.2 GB free hard disk space

## Print specifications

- Resolution: 1200 x 1200 dpi black, 4800 optimized dpi color, 4800 dpi 6 ink
- Speed: Print speeds vary according to the complexity of the document.
- Method: Drop-on-demand thermal inkjet
- Language: Lightweight Imaging Device Interface Language (LIDIL)

## Copy specifications

- Digital image processing
- Up to 99 copies from original
- Copy speeds vary according to the complexity of the document.
- Digital zoom: from 25 to 400%
- Fit to page, pre-scan



Mode	Type	Scan resolution (dpi)*
Best	Black	up to 600 x 1200
	Color	up to 600 x 1200
Normal	Black	up to 300 x 300
	Color	up to 300 x 300
Fast	Black	up to 300 x 300
	Color	up to 300 x 300

\* Maximum at 400% scaling.

## Fax specifications

- Walk-up black and white and color fax capability
- Up to 100 speed dials
- Up to 100-page memory (Varies by model, based on ITU-T Test Image #1 at standard resolution). More complicated pages or higher resolution takes longer and uses more memory.
- Manual multiple-page fax
- Automatic busy redial up to five times
- Automatic no-answer redial one time
- Confirmation and activity reports
- CCITT/ITU Group 3 fax with Error Correction Mode
- 33.6 Kbps transmission
- Fax speeds vary according to the complexity of the document.
- Ring detect with automatic fax/answering machine switching

	Photo (dpi)	Very Fine (dpi)	Fine (dpi)	Standard (dpi)
Black	196 x 203 (8-bit grayscale)	300 x 300	196 x 203	196 x 98
Color	200 x 200	200 x 200	200 x 200	200 x 200

## Scan specifications

- Image editor included
- Integrated OCR software automatically converts scanned text to editable text
- Scan speeds vary according to the complexity of the document
- Twain-compliant interface
- Resolution: 1200 x 2400 dpi optical, up to 19,200 dpi enhanced
- Color: 16-bit per RGB color, 48-bit total
- Maximum scan size from glass: 216 x 297 mm (8.5 x 11.7 inches)

## Environmental specifications

- Recommended operating temperature range: 15° to 32° C (59° to 90° F)
- Allowable operating temperature range: 5° to 40° C (41° to 104° F)
- Humidity: 15% to 85% RH non-condensing
- Non-operating (Storage) temperature range: -40° to 60° C (-40° to 140° F)

In the presence of high electromagnetic fields it is possible the output from the device might be slightly distorted.

HP recommends using a USB cable less than or equal to 3 m (10 feet) in length to minimize injected noise due to potential high electromagnetic fields.

## Electrical specifications

- Maximum power consumption: 60 W
- Idle state power consumption: 5.593 W
- Input voltage: AC 100 to 240 VAC, 1A, 50-60 Hz, grounded
- Output voltage: DC 36W, 32 Vdc 850 mA, 16Vdc 550 mA

## Acoustic emission specifications (noise levels per ISO 7779)

### Sound pressure (bystander position)

- Color printing: LpAd 43 (dBA)
- Black-and-white printing (Normal mode) and copying: LpAd 48 (dBA)
- Idle: LpAd 21 (dBA)

### Sound power

- Color printing: LwAd 5.6 (BA)
- Black-and-white printing (Normal mode): LwAd 6.1 (BA)
- Black-and-white copying: LwAd 6.0 (BA)
- Idle: LwAd 3.3 (BA)

---

# D Regulatory information

The device meets product requirements from regulatory agencies in your country/region.

This section contains the following topics:

- [FCC statement](#)
- [Notice to users in Korea](#)
- [VCCI \(Class B\) compliance statement for users in Japan](#)
- [Notice to users in Japan about the power cord](#)
- [Noise emission statement for Germany](#)
- [RoHS notices \(China only\)](#)
- [Notice to users of the U.S. telephone network: FCC requirements](#)
- [Notice to users of the Canadian telephone network](#)
- [Notice to users in the European Economic Area](#)
- [Australia wired fax statement](#)
- [Warning for Australia and New Zealand with phone handset](#)
- [Declaration of conformity](#)
- [Regulatory model number](#)
- [Environmental product stewardship program](#)

## FCC statement

### FCC statement

The United States Federal Communications Commission (in 47 CFR 15.105) has specified that the following notice be brought to the attention of users of this product.

This equipment has been tested and found to comply with the limits for a Class B digital device, pursuant to Part 15 of the FCC Rules. These limits are designed to provide reasonable protection against harmful interference in a residential installation. This equipment generates, uses and can radiate radio frequency energy and, if not installed and used in accordance with the instructions, may cause harmful interference to radio communications. However, there is no guarantee that interference will not occur in a particular installation. If this equipment does cause harmful interference to radio or television reception, which can be determined by turning the equipment off and on, the user is encouraged to try to correct the interference by one or more of the following measures:

- Reorient the receiving antenna.
- Increase the separation between the equipment and the receiver.
- Connect the equipment into an outlet on a circuit different from that to which the receiver is connected.
- Consult the dealer or an experienced radio/TV technician for help.

For further information, contact:

Manager of Corporate Product Regulations  
Hewlett-Packard Company  
3000 Hanover Street  
Palo Alto, Ca 94304  
(650) 857-1501

Modifications (part 15.21)

The FCC requires the user to be notified that any changes or modifications made to this device that are not expressly approved by HP may void the user's authority to operate the equipment.

This device complies with Part 15 of the FCC Rules. Operation is subject to the following two conditions: (1) this device may not cause harmful interference, and (2) this device must accept any interference received, including interference that may cause undesired operation.

## Notice to users in Korea

사용자 안내문(B급 기기)

이 기기는 비업무용으로 전자파 적합 등록을 받은 기기로서, 주거지역에서는 물론 모든 지역에서 사용할 수 있습니다.

## VCCI (Class B) compliance statement for users in Japan

この装置は、情報処理装置等電波障害自主規制協議会（VCCI）の基準に基づくクラスB情報技術装置です。この装置は、家庭環境で使用することを目的としていますが、この装置がラジオやテレビジョン受信機に近接して使用されると受信障害を引き起こすことがあります。

取り扱い説明書に従って正しい取り扱いをして下さい。

## Notice to users in Japan about the power cord

製品には、同梱された電源コードをお使い下さい。  
同梱された電源コードは、他の製品では使用出来ません。

## Noise emission statement for Germany

### Geräuschemission

LpA < 70 dB am Arbeitsplatz im Normalbetrieb nach DIN 45635 T. 19

## RoHS notices (China only)

有毒有害物质表						
根据中国《电子信息产品污染控制管理办法》						
零件描述	有毒有害物质和元素					
	铅	汞	镉	六价铬	多溴联苯	多溴联苯醚
外壳和托盘*	0	0	0	0	0	0
电线*	0	0	0	0	0	0
印刷电路板*	X	0	0	0	0	0
打印系统*	X	0	0	0	0	0
显示器*	X	0	0	0	0	0
喷墨打印机墨盒*	0	0	0	0	0	0
驱动光盘*	X	0	0	0	0	0
扫描仪*	X	X	0	0	0	0
网络配件*	X	0	0	0	0	0
电池板*	X	0	0	0	0	0
自动双面打印系统*	0	0	0	0	0	0
外部电源*	X	0	0	0	0	0

0: 指此部件的所有均一材质中包含的这种有毒有害物质, 含量低于SJ/T11363-2006 的限制  
X: 指此部件使用的均一材质中至少有一种包含的这种有毒有害物质, 含量高于SJ/T11363-2006 的限制  
注: 环保使用期限的参考标识取决于产品正常工作的温度和湿度等条件  
\*以上只适用于使用这些部件的产品

## Toxic and hazardous substance table

## Notice to users of the U.S. telephone network: FCC requirements

### Notice to users of the U.S. telephone network: FCC requirements

This equipment complies with FCC rules, Part 68. On this equipment is a label that contains, among other information, the FCC Registration Number and Ringer Equivalent Number (REN) for this equipment. If requested, provide this information to your telephone company.

An FCC compliant telephone cord and modular plug is provided with this equipment. This equipment is designed to be connected to the telephone network or premises wiring using a compatible modular jack which is Part 68 compliant. This equipment connects to the telephone network through the following standard network interface jack: USOC RJ-11C.

The REN is useful to determine the quantity of devices you may connect to your telephone line and still have all of those devices ring when your number is called. Too many devices on one line might result in failure to ring in response to an incoming call. In most, but not all, areas the sum of the RENs of all devices should not exceed five (5). To be certain of the number of devices you may connect to your line, as determined by the REN, you should call your local telephone company to determine the maximum REN for your calling area.

If this equipment causes harm to the telephone network, your telephone company might discontinue your service temporarily. If possible, they will notify you in advance. If advance notice is not practical, you will be notified as soon as possible. You will also be advised of your right to file a complaint with the FCC. Your telephone company might make changes in its facilities, equipment, operations, or procedures that could affect the proper operation of your equipment. If they do, you will be given advance notice so you will have the opportunity to maintain uninterrupted service. If you experience trouble with this equipment, please contact the manufacturer, or look elsewhere in this manual, for warranty or repair information. Your telephone company might ask you to disconnect this equipment from the network until the problem has been corrected or until you are sure that the equipment is not malfunctioning.

This equipment may not be used on coin service provided by the telephone company.

Connection to party lines is subject to state tariffs. Contact your state public utility commission, public service commission, or corporation commission for more information.

This equipment includes automatic dialing capability. When programming and/or making test calls to emergency numbers:

- Remain on the line and explain to the dispatcher the reason for the call.
- Perform such activities in the off-peak hours, such as early morning or late evening.



**Note** The FCC hearing aid compatibility rules for telephones are not applicable to this equipment.

The Telephone Consumer Protection Act of 1991 makes it unlawful for any person to use a computer or other electronic device, including fax machines, to send any message unless such message clearly contains in a margin at the top or bottom of each transmitted page or on the first page of transmission, the date and time it is sent and an identification of the business, other entity, or other individual sending the message and the telephone number of the sending machine or such business, other entity, or individual. (The telephone number provided might not be a 900 number or any other number for which charges exceed local or long-distance transmission charges.) In order to program this information into your fax machine, you should complete the steps described in the software.

## Notice to users of the Canadian telephone network

### **Note à l'attention des utilisateurs du réseau téléphonique canadien/Notice to users of the Canadian telephone network**

Cet appareil est conforme aux spécifications techniques des équipements terminaux d'Industrie Canada. Le numéro d'enregistrement atteste de la conformité de l'appareil. L'abréviation IC qui précède le numéro d'enregistrement indique que l'enregistrement a été effectué dans le cadre d'une Déclaration de conformité stipulant que les spécifications techniques d'Industrie Canada ont été respectées. Néanmoins, cette abréviation ne signifie en aucun cas que l'appareil a été validé par Industrie Canada.

Pour leur propre sécurité, les utilisateurs doivent s'assurer que les prises électriques reliées à la terre de la source d'alimentation, des lignes téléphoniques et du circuit métallique d'alimentation en eau sont, le cas échéant, branchées les unes aux autres. Cette précaution est particulièrement importante dans les zones rurales.



**Remarque** Le numéro REN (Ringer Equivalence Number) attribué à chaque appareil terminal fournit une indication sur le nombre maximal de terminaux qui peuvent être connectés à une interface téléphonique. La terminaison d'une interface peut se composer de n'importe quelle combinaison d'appareils, à condition que le total des numéros REN ne dépasse pas 5.

Basé sur les résultats de tests FCC Partie 68, le numéro REN de ce produit est 0.0B.

This equipment meets the applicable Industry Canada Terminal Equipment Technical Specifications. This is confirmed by the registration number. The abbreviation IC before the registration number signifies that registration was performed based on a Declaration of Conformity indicating that Industry Canada technical specifications were met. It does not imply that Industry Canada approved the equipment.

Users should ensure for their own protection that the electrical ground connections of the power utility, telephone lines and internal metallic water pipe system, if present, are connected together. This precaution might be particularly important in rural areas.



**Note** The REN (Ringer Equivalence Number) assigned to each terminal device provides an indication of the maximum number of terminals allowed to be connected to a telephone interface. The termination on an interface might consist of any combination of devices subject only to the requirement that the sum of the Ringer Equivalence Numbers of all the devices does not exceed 5.

The REN for this product is 0.0B, based on FCC Part 68 test results.

## Notice to users in the European Economic Area

### Notice to users in the European Economic Area



This product is designed to be connected to the analog Switched Telecommunication Networks (PSTN) of the European Economic Area (EEA) countries/regions.

Network compatibility depends on customer selected settings, which must be reset to use the equipment on a telephone network in a country/region other than where the product was purchased. Contact the vendor or Hewlett-Packard Company if additional product support is necessary.

This equipment has been certified by the manufacturer in accordance with Directive 1999/5/EC (annex II) for Pan-European single-terminal connection to the public switched telephone network (PSTN). However, due to differences between the individual PSTNs provided in different countries, the approval does not, of itself, give an unconditional assurance of successful operation on every PSTN network termination point.

In the event of problems, you should contact your equipment supplier in the first instance.

This equipment is designed for DTMF tone dialing and loop disconnect dialing. In the unlikely event of problems with loop disconnect dialing, it is recommended to use this equipment only with the DTMF tone dial setting.

## Australia wired fax statement

In Australia, the HP device must be connected to Telecommunication Network through a line cord which meets the requirements of the Technical Standard AS/ACIF S008.

## Warning for Australia and New Zealand with phone handset

Warning! This equipment will be inoperable when main power fails.

Warning! The handset ear cap used with this product may attract dangerous objects like pins, staples, or needles. Take care to avoid harm that might occur from the retention of dangerous objects on the ear piece of the handset.



# Declaration of conformity

		<b>DECLARATION OF CONFORMITY</b> according to ISO/IEC 17050-1 and EN 17050-1	
<b>Manufacturer's Name:</b>	Hewlett-Packard Company	DoC#: SDGOB-0505-CATHAY rel.1.0	
<b>Manufacturer's Address:</b>	16399 West Bernardo Drive San Diego, CA 92127, USA		
<b>declares, that the product</b>			
<b>Product Name:</b>	HP Officejet J5500 series		
<b>Regulatory Model:<sup>2)</sup></b>	SDGOB-0505		
<b>Product Options:</b>	ALL		
<b>Power Adapter:</b>	0957-2153 & 0957-2146		
<b>conforms to the following Product Specifications:</b>			
<b>SAFETY:</b>	IEC 60950-1: 2001 IEC 60825-1 Edition 1.2: 2001 AS/NZS 60950: 2000 / GB4943:2001		
<b>EMC:</b>	CISPR 22:1997+A1+A2 Class B GB9254: 1998		
<b>Supplementary Information:</b>			
1. The product was tested in a typical configuration.			
2. For regulatory purposes, these products are assigned a Regulatory model number. This number should not be confused with the product name or the product number(s).			
San Diego, CA, USA 21 June, 2007			
<b>For Regulatory Topics only, contact:</b>			
EMEA:	Hewlett-Packard GmbH, HQ-TRE, Herrenberger Strasse 140, 71034 Böblingen, Germany <a href="http://www.hp.com/go/certificates">www.hp.com/go/certificates</a>		
Australia Contact:	Product Regulations Manager, Hewlett-Packard Australia Ltd., 31-41 Joseph Street, Blackburn, Victoria 3130, Australia.		

## Regulatory model number

For regulatory identification purposes, your product is assigned a Regulatory Model Number. The Regulatory Model Number for your product is SDGOB-0505. This regulatory number should not be confused with the marketing name (HP Officejet J5500 All-in-One series) or product number.

## Environmental product stewardship program

Hewlett-Packard is committed to providing quality products in an environmentally sound manner. Design for recycling has been incorporated into this product. The number of materials has been kept to a minimum while ensuring proper functionality and reliability. Dissimilar materials have been designed to separate easily. Fasteners and other connections are easy to locate, access, and remove using common tools. High priority parts have been designed to access quickly for efficient disassembly and repair.

For more information, visit HP's Commitment to the Environment Web site at:

[www.hp.com/hpinfo/globalcitizenship/environment/index.html](http://www.hp.com/hpinfo/globalcitizenship/environment/index.html)

This section contains the following topics:

- [Paper use](#)
- [Plastics](#)
- [Material safety data sheets](#)
- [Recycling program](#)
- [HP inkjet supplies recycling program](#)
- [Disposal of waste equipment by users in private households in the European Union](#)
- [Energy consumption](#)

### Paper use

This product is suited for the use of recycled paper according to DIN 19309 and EN 12281:2002.

### Plastics

Plastic parts over 25 grams are marked according to international standards that enhance the ability to identify plastics for recycling purposes at the end of product life.

### Material safety data sheets

Material safety data sheets (MSDS) can be obtained from the HP Web site at:

[www.hp.com/go/msds](http://www.hp.com/go/msds)

### Recycling program

HP offers an increasing number of product return and recycling programs in many countries/regions, and partners with some of the largest electronic recycling centers throughout the world. HP conserves resources by reselling some of its most popular products. For more information regarding recycling of HP products, please visit:

[www.hp.com/hpinfo/globalcitizenship/environment/recycle/](http://www.hp.com/hpinfo/globalcitizenship/environment/recycle/)

### HP inkjet supplies recycling program

HP is committed to protecting the environment. The HP Inkjet Supplies Recycling Program is available in many countries/regions, and lets you recycle used print cartridges and ink cartridges free of charge. For more information, go to the following Web site:

[www.hp.com/hpinfo/globalcitizenship/environment/recycle/](http://www.hp.com/hpinfo/globalcitizenship/environment/recycle/)

# Disposal of waste equipment by users in private households in the European Union



**Disposal of Waste Equipment by Users in Private Households in the European Union**  
 This symbol on the product or on its packaging indicates that this product must not be disposed of with your other household waste. Instead, it is your responsibility to dispose of your waste equipment by handing it over to a designated collection point for the recycling of waste electrical and electronic equipment. The separate collection and recycling of your waste equipment at the time of disposal will help to conserve natural resources and ensure that it is recycled in a manner that protects human health and the environment. For more information about where you can drop off your waste equipment for recycling, please contact your local city office, your household waste disposal service or the shop where you purchased the product.

**Évacuation des équipements usagés par les utilisateurs dans les foyers privés au sein de l'Union européenne**  
 La présence de ce symbole sur le produit ou sur son emballage indique que vous ne pouvez pas vous débarrasser de ce produit de la même façon que de vos déchets courants. Au contraire, vous êtes responsable de l'évacuation de vos équipements usagés et, à cet effet, vous êtes tenu de les remettre à un point de collecte agréé pour le recyclage des équipements électriques et électroniques usagés. Le tri, l'évacuation et le recyclage séparés de vos équipements usagés permettent de préserver les ressources naturelles et de s'assurer que ces équipements sont recyclés dans le respect de la santé humaine et de l'environnement. Pour plus d'informations sur les lieux de collecte des équipements usagés, veuillez contacter votre mairie, votre service de traitement des déchets ménagers ou le magasin où vous avez acheté le produit.

**Entsorgung von Elektrogeräten durch Benutzer in privaten Haushalten in der EU**  
 Dieses Symbol auf dem Produkt oder dessen Verpackung gibt an, dass das Produkt nicht zusammen mit dem Restmüll entsorgt werden darf. Es obliegt daher Ihrer Verantwortung, das Gerät an einer entsprechenden Stelle für die Entsorgung und Wiederverwertung von Elektrogeräten aller Art abzugeben (z.B. ein Wertstoffhof). Die separate Sammlung und das Recyceln Ihrer alten Elektrogeräte zum Zeitpunkt Ihrer Entsorgung trägt zum Schutz der Umwelt bei und gewährleistet, dass sie auf eine Art und Weise recycelt werden, die keine Gefährdung für die Gesundheit des Menschen und der Umwelt darstellt. Weitere Informationen darüber, wo Sie alte Elektrogeräte zum Recyceln abgeben können, erhalten Sie bei den örtlichen Behörden, den Wertstoffhöfen oder dort, wo Sie das Gerät erworben haben.

**Smaltimento di apparecchiature da rottamare da parte di privati nell'Unione Europea**  
 Questo simbolo che appare sul prodotto o sulla confezione indica che il prodotto non deve essere smaltito assieme agli altri rifiuti domestici. Gli utenti devono provvedere allo smaltimento delle apparecchiature da rottamare in un punto di raccolta indicato per il riciclaggio delle apparecchiature elettriche ed elettroniche. La raccolta e il riciclaggio separati delle apparecchiature da rottamare in fase di smaltimento favoriscono la conservazione delle risorse naturali e garantiscono che tali apparecchiature vengano rottamate nel rispetto dell'ambiente e della salute della salute. Per ulteriori informazioni sui punti di raccolta delle apparecchiature da rottamare, contattare il proprio comune di residenza, il servizio di smaltimento dei rifiuti locale o il negozio presso il quale è stato acquistato il prodotto.

**Eliminación de residuos de aparatos eléctricos y electrónicos por parte de usuarios domésticos en la Unión Europea**  
 Este símbolo en el producto o en el embalaje indica que no se puede desechar el producto junto con los residuos domésticos. Por el contrario, es responsabilidad del usuario entregarlo en un punto de recogida designado de residuos de aparatos electrónicos y eléctricos. El reciclaje y la recogida por separado de estos residuos en el momento de la eliminación ayudará a preservar recursos naturales y a garantizar que el reciclaje proteja la salud y el medio ambiente. Si desea información adicional sobre los lugares donde puede dejar estos residuos para su reciclado, póngase en contacto con las autoridades locales de su ciudad, con el servicio de gestión de residuos domésticos o con la tienda donde adquirió el producto.

**Likvidace vyzlúožilého zařizení uživateli v domácnosti v zemích EU**  
 Toto značka na produktu nebo na jeho obalu znamená, že tento produkt nesmí být likvidován společně s ostatním domovním odpadem. Odpovídáte za to, že vyzlúožilé zařízení bude předáno k likvidaci v určených sběrných místech určených k recyklaci vyzlúožilých zařízení. Likvidace vyzlúožilých zařízení samostatně a jejich oddělené sběrné a recyklační napomáhá zachovat přírodní zdroje a životní prostředí. Další informace o tom, kam můžete vyzlúožilé zařízení předat k recyklaci, můžete získat od úřadů místní samosprávy, od společnosti provádějící svoz a likvidaci domovního odpadu nebo v obchodě, kde jste produkt zakoupili.

**Bortskaffelse af affaldsudstyr der bruges i private husholdninger i EU**  
 Dette symbol på produktet eller på dets emballage indikerer, at produktet ikke må bortskaffes sammen med andet husholdningsaffald. I stedet er det dit ansvar at bortskaffe affaldsudstyr ved at hævde det på det beredte indsamlingssted med henblik på genbrug af elektrisk og elektronisk affaldsudstyr. Den separate indsamling og genbrug af dit affaldsudstyr til fordel for miljøet vil hjælpe med at bevare naturlige ressourcer og sikre, at genbrugsindsatsen beskytter menneskers helbreds og miljøet. Hvis du vil vide mere om, hvor og når du kan aflevere dit affaldsudstyr, kan du kontakte kommunen, den lokale renovationsvæsen eller den butik, hvor du købte produktet.

**Afvoer van afgedankte apparatuur door gebruikers in particuliere huishoudens in de Europese Unie**  
 Dit symbool op het product of de verpakking geeft aan dat dit product niet mag worden afgevoerd met het huishoudelijk afval. Het is uw verantwoordelijkheid uw afgedankte apparatuur af te leveren op een aangewezen inzamelpunt voor de verwerking van afgedankte elektrische en elektronische apparatuur. De gescheiden inzameling en verwerking van uw afgedankte apparatuur draagt bij tot het sparen van natuurlijke bronnen en tot het hergebruik van materiaal op een wijze die de volksgezondheid en het milieu beschermt. Voor meer informatie over waar u uw afgedankte apparatuur kunt inleveren voor recycling kunt u contact opnemen met het gemeentehuis in uw woonplaats, de reinigingsdienst of de winkel waar u het product hebt aangekocht.

**Erasmagjordinimastes kasutusel käivaldatavate seadmete käitlemine Euroopa Liidus**  
 Kui tootel või toote pakendil on see sümbol, siin teada toodet visata olmejäätmete hulka, fise lohus on vüa tarbetuks muutunud seade selleks ettenhütdud elektrilise elektroonikaseadmete utiliseerimiskohale. Utiliseeritavate seadmete emald kogumine ja käitlemine aitab sästa loodusvarasid ning tagada, et käitlemine toimiks inimtsest lervelise ja keskkonnale ohult. Lisateavet selle kohta, kuh saate utiliseeritava seadme kasutusseks vüa, saate küsida kohalikus omavalitsuses, olmejäätmete utiliseerimiskohalt või kauplust, kust te seadme ostsite.

**Hävettävien laitteiden käsittely kotitalouksissa Euroopan unionin alueella**  
 Tämä huuteessa tai sen pakkauksessa oleuva merkintä osoittaa, että tuotetta ei saa hävittää talousjätteen mukana. Käyttäjän velvollisuus on huolehtia siitä, että hävettävät laitteet toimittetaan erikseen kiertokäsiteltävien jätteen keräilyasemalle. Hävettävien laitteiden erillinen käsittely ja kierrätyksen säätö auttavat luonnonvara- ja ympäristönsuojelua. Lisäksi informaatio oim, missä ja milloin laitteita voidaan toimittaa, on saatavilla paikallisilta viranomaisilta, jätteenkäsittelijältä tai tuotteen jällemyyjältä.

**Απόρριψη αγχρήτων συσκευών στην Ευρωπαϊκή Ένωση**  
 Το παρόν σύμβολο στον εξοπλισμό ή τη συσκευασία του υποδηλώνει ότι το προϊόν αυτό δεν πρέπει να μπει με άλλα οικιακά απορρίμματα. Αντίθετα, ευθύνη σας είναι να απορρίψετε τα αγχρήτα συσκευές σε μια συγκεκριμένη τοποθεσία συλλογής απορριμμάτων για την ανακύκλωση αγχρήτων ηλεκτρικών και ηλεκτρονικών εξοπλισμών. Η χωριστή συλλογή και ανακύκλωση των αγχρήτων συσκευών θα συμβάλει στη διατήρηση των φυσικών πόρων και στη διασφάλιση ότι θα ανακυκλωθούν με τον τρόπο, όπου να προστατεύεται η υγεία των ανθρώπων και το περιβάλλον. Για περισσότερες πληροφορίες σχετικά με το πού μπορεί να απορρίψετε τις αγχρήτες συσκευές για ανακύκλωση, επισκεφτείτε με τη κατά τόπους αρμόδια αρχή ή με το κατάστημα από το οποίο αγοράσotte το προϊόν.

**A hulladéknagyvok kezelése a magánháztartásokban az Európai Unióban**  
 Ez a szimbólum, amely a terméknek vagy annak csomagolásának van feltüntetve, azt jelzi, hogy a termék nem kezelhető együtt az egyéb háztartási hulladékkal. Az Ön feladata, hogy a kizárólag hulladékgyűjtésre kijelölt gyűjtőhelyre, amely az elektronikus hulladékgyűjtés és az elektronikus berendezések újrahasznosításának logikájának megfelelően, a hulladékgyűjtő állomásoknál gyűjtés és újrahasznosítás hozzájárul a természeti erőforrások megőrzéséhez, egyúttal az, hogy a hulladék újrahasznosítása az egészségére és a környezetére nem ártalmas módon történik. Ha további információkat szeretne kapni azokról a helyekről, ahol leadhatja újrahasznosításra a hulladékanyagokat, forduljon a helyi önkormányzatához, a háztartási hulladék begyűjtésével foglalkozó vállalatához vagy a termék forgalmazójához.

**Letajutaj atrivbosnas na nederigim teritiam Erépas Savienbas privatis mejsimicibas**  
 Sis simbols uz ierices vai las ierokomtu norada, ka las ieris nederigt izmet kopā ar pārējiem mājamsaimniecības atkritumiem. Jus esat atbildīgs par atrivbosnos na nederīgās ierices, to nododot norādītajā savācības vietā, lai tiku veikta nederīgo elektrisko un elektronisko aprīkojumu atvešana pārstrādē. Speciāla nederīgās ierices savācšana un atvešana pārstrādē palīdz ietaupīt dabas resursus un nodrošina labu atvešanu pārstrādē, kas sargā cilvēku veselību un apkārtni vidi. Lai iegūtu papildu informāciju par to, kur atveštat pārstrādē var nodot nederīgo ierici, lūdz, sazināties ar vietējo pašvaldību, mājamsaimniecības atkritumu savācības dienestu vai veikalu, kurā iegādājāties šo ierici.

**Europas Sānjugas vartotāji ir privātie namu ūki atliekoms jangos iēmestas**  
 Sis simbols attēd produkta arba ir pakoties norādē, ka produkts negali būt iēmestas kartu su kitoms namu ūki atliekoms. Jus atbildēts iēmesti savo atliekoms jangos atdūdomā jā j atliekoms elektroniskās un elektriskās jangos pērdiboms punktās. Jūs atliekoms jangos būs atkritums savienāšanai un pērdiboms, kas īsāgumi nodrošināts atkritums izstrādāšanai un izstrādāšanai, kas jangos jang pērdibēts žmogaus veselībai ir gantē kaitējums būdā. Dālē informācija apie tā, kur galēts iēmesti atliekoms pērdibāt širts jangos kriptoks j atkritums savienāšanai, namu ūki atlieku išežimo tarmjā arba j parādītumos, kurjos pirkote produktā.

**Utilizacija zuzlytogo sprzetu przez uzytkownikow domowych w Unii Europejskiej**  
 Symbol ten umieszczony na produkcie lub opakowaniu oznacza, że tego produktu nie należy wyrzucać razem z innymi odpadami domowymi. Użytkownik jest odpowiedzialny za dostarczenie zużytego sprzętu do wyznaczonego punktu gromadzenia zużytych urządzeń elektrycznych i elektronicznych. Oddanie osobno i recykling tego typu odpadów przyczynia się do ochrony zasobów naturalnych, i jest bezpieczny dla zdrowia i środowiska naturalnego. Dalsze informacje na temat sposobu użycia zużytych urządzeń można uzyskać u odpowiedzialnych władz lokalnych, w przedsiębiorstwach zajmujących się usuwaniem odpadów lub w miejscu zakupu produktu.

**Descarte de equipamentos usados em residências da União Europeia**  
 Este símbolo no produto ou no embalagem indica que o produto não pode ser descartado junto com o lixo doméstico. No entanto, é sua responsabilidade levar os equipamentos a serem descartados a um ponto de coleta designado para o reciclagem de equipamentos eletro-eletrônicos. A coleta separada e o reciclagem dos equipamentos no momento do descarte ajudam na conservação dos recursos naturais e garantem que os equipamentos sejam reciclados de forma a proteger a saúde das pessoas e o meio ambiente. Para obter mais informações sobre onde descartar equipamentos para reciclagem, entre em contato com o escritório local de seu cidade, o serviço de limpeza pública de seu bairro ou o loja em que adquiriu o produto.

**Postup používat'ov v krajínach Európskej únie pri vyhazovaní zariadenia v domácom používaní do odpadu**  
 Tento symbol na produkte alebo na jeho obale znamená, že tento produkt nesmí byť vyhazovaný spoločne s ostatným domovním odpadom. Zodpovednosť odovzdať toto zariadenie na zbernom mieste, kde sa zabezpečuje recyklácia elektrických a elektronických zariadení. Samostatný zber a recyklácia zariadenia užitečného na odpad pomôžu ochrániť prírodné zdroje a zabezpečí taký spôsob recyklácie, ktorý bude chráni ľudské zdravie a životné prostredie. Dalsie informácie o separovanom zbere a recyklácii získate na miestnom obecnom úrade, vo firme zabezpečujúcej zber vášho komunálneho odpadu v predmí, kde ste produkt kúpili.

**Avretyje v otdelnoe opreme v gosopidnitel'nykh zedre vrazdajnykh**  
 To znak na izdelku ili embalazhi izdelka pomeni, da izdelka ne smete odlagati skupaj z drugimi gospodinjstvenimi odpadki. Odpadno opreme ste dolžni oddati na določeno zbirno mesto za recikliranje odpadne elektrike in elektronske opreme. Z ločenim zbiranjem in recikliranjem odpadne opreme ob odložitvi bodo pomogli ochraniti naravne vire in zagotovili, da bo odpadna oprema reciklirana tako, da se ne škoduje zdravju ljudi in okolje. Več informacij o mestih, kjer lahko oddate odpadno opremo za recikliranje, lahko dobite na občini, v komunalnem podjetju ali trgovini, kjer ste izdelki kupili.

**Kasserung av förbrukningsmaterial, för hem- och privatvårdare i EU**  
 Produktier eller produktförpackningar med den här symbolen till innte kasserats med vanligt hushållsavfall. I stället får du ansvar för att produkten lämnas till en behörig återvinningssation för hantering av el- och elektronisk-produkter. Genom att lämna kasserade produkter till övningstillämpliga till återvinning hjälper du till att bevara våra gemensamma naturresurser. Dessutom skyddas både människor och miljön när produkter återvinns på rätt sätt. Kommunala myndigheter, sophanteringsfördrag eller butiken där varon köptes kan ge mer information om var och om du lämnar kasserade produkter för återvinning.

- English
- Français
- Deutsch
- Italiano
- Español
- Česky
- Dansk
- Nederlands
- Esti
- Somi
- Ελληνικά
- Magyar
- Latvīski
- Lietuvīški
- Polski
- Portugies
- Slovenšcina
- Slovenšcina
- Svenska

### **Energy consumption**

This product is designed to reduce power consumption and save natural resources without compromising product performance. It has been designed to reduce total energy consumption both during operation and when the device is not active. Specific information on power consumption may be found in the printed documentation that came with the device.

---

# Index

## Symbols/Numerics

(ADF) automatic document feeder  
clean 106  
feeding problems, troubleshoot 106  
10 x 15 cm photo paper  
copy 33  
load 23  
4 x 6 inch photo paper  
copy 33  
load 23

## A

A4 paper, load 21  
accessibility 4  
acoustic emissions 150  
ADF (automatic document feeder)  
capacity 16  
load originals 16  
media sizes supported 19  
administrator  
settings 64  
ADSL, fax setup with  
parallel phone systems 70  
after the support period 143  
align print cartridges 98  
answer ring pattern  
change 57  
parallel phone systems 72  
answering machine  
fax tones recorded 132  
set up with fax (parallel phone systems) 81  
set up with fax and modem 82  
attention light 10  
automatic document feeder (ADF)  
capacity 16  
clean 106  
feeding problems, troubleshoot 106

load originals 16  
media sizes supported 19  
automatic fax reduction 54

## B

backup fax reception 51  
baud rate 59  
best copy quality 34  
black and white pages  
copy 32  
fax 41  
troubleshoot 113  
black dots or streaks, troubleshoot  
copies 117  
scan 121  
blank pages, troubleshoot  
copy 116  
print 110  
scan 121  
blocked fax numbers  
set up 54  
both sides, print on 30  
buttons, control panel 9

## C

calibrate linefeed 99  
cancel  
button 10  
copy 37  
print job 31  
scan 40  
scheduled fax 45  
capacity  
ADF 16  
trays 20  
cards  
guidelines 18  
tray supporting 20  
cartridges. *See* print cartridges  
clean  
automatic document feeder 106  
exterior 105  
glass 104  
lid backing 105

print cartridge contacts 100  
print cartridge ink nozzle  
area 101  
print cartridges 99  
scanner glass 104  
color  
copies 37  
fax 47  
color copy 32  
colored text, and OCR 40  
colors  
bleeding 114  
faded or dull 113  
print black and white, troubleshoot 113  
troubleshoot 114  
wrong 114  
computer modem  
shared with fax (parallel phone systems) 75  
shared with fax and answering machine (parallel phone systems) 82  
shared with fax and voice line (parallel phone systems) 77  
shared with fax and voice mail (parallel phone systems) 87  
confirmation reports, fax 61  
connections  
features available 10  
connectors, locating 9  
contrast, fax 49  
control panel  
administrator settings 64  
buttons 9  
copy from 32  
enter text and symbols 14  
faceplate, removing 145  
lights 9  
locating 8  
menus 11  
messages 11  
scan from 38

- send faxes 42
- send scans to programs 39
- settings, change 12
- copy
  - button 10
  - cancel 37
  - enhance light areas 37
  - from the control panel 32
  - legal to letter 35
  - number of copies 33
  - paper size 33
  - paper types,
    - recommended 33
  - photos, enhance 36
  - quality 34, 117
  - reduce 35
  - settings 32
  - specifications 148
  - speed 34
  - text, enhance 36
  - troubleshoot 116
- Copy menu 11
- correct port test, fax 123
- critical error messages 12
- custom-sized media
  - guidelines 19
  - print on 27
- customer support
  - electronic 140
  - phone support 140
  - warranty 143
- cut-off pages, troubleshoot 111

## D

- dark images, troubleshoot
  - copies 117
  - scans 121
- darken
  - copies 36
  - faxes 49
- Declaration of Conformity (DOC) 157
- default settings
  - control panel 12
  - copy 33
  - driver 30
  - fax 50
  - print 30
- deleting faxes from memory 52
- dial tone test, failure 125
- dial type, setting 58

- dial-up modem
  - shared with fax (parallel phone systems) 75
  - shared with fax and answering machine (parallel phone systems) 82
  - shared with fax and voice line (parallel phone systems) 77
  - shared with fax and voice mail (parallel phone systems) 87
- distinctive ringing
  - change 57
  - parallel phone systems 72
- DOC 157
- documentation 7
- dots or streaks, troubleshoot
  - copies 117
- dots, troubleshoot
  - scan 121
- double-sided printing 30
- driver
  - settings 30
  - version 140
  - warranty 139
- DSL, fax setup with
  - parallel phone systems 70
- duty cycle 147

## E

- ECM. See error correction mode edit
  - scanned images 39
  - text in OCR program 40
- electrical specifications 150
- envelopes
  - guidelines 18
  - load 25
  - tray supporting 20
- environmental
  - specifications 149
- environmental sustainability program 158
- error correction mode 50
- error messages
  - control panel 12
  - unable to activate TWAIN source 120
- error reports, fax 61
- error-correction mode, fax 58

## F

- faded copies 116
- faded stripes on copies,
  - troubleshoot 117
- fast copy quality 34
- fax
  - answer mode 57
  - answering machine and modem, shared with (parallel phone systems) 82
  - answering machine
    - troubleshoot 132
  - answering machine, set up (parallel phone systems) 81
  - auto answer 57
  - backup fax reception 51
  - blocking numbers 54
  - button 10
  - confirmation reports 61
  - contrast 49
  - darken or lighten 49
  - default settings 50
  - deleting from memory 52
  - dial tone test, failed 125
  - dial type, setting 58
  - distinctive ringing setup (parallel phone systems) 72
  - distinctive ringing, change pattern 57
  - DSL, set up (parallel phone systems) 70
  - enter text and symbols 14
  - error correction mode 50
  - error reports 61
  - error-correction mode 58
  - forwarding 53
  - header 56
  - Internet, over 59
  - ISDN line, set up (parallel phone systems) 71
  - lighten or darken 49
  - line condition test,
    - failed 126
  - log, print 61
  - manual receive 51
  - modem and answering machine, shared with (parallel phone systems) 82

- modem and voice line,
    - shared with (parallel phone systems) 77
  - modem and voice mail,
    - shared with (parallel phone systems) 87
  - modem, shared with (parallel phone systems) 75
  - monitor dialing 43
  - paper size 54
  - parallel phone systems 66
  - pause 14
  - PBX system, set up (parallel phone systems) 71
  - phone cord connection test,
    - failed 123
  - phone cord too short 132
  - phone cord type test,
    - failed 124
  - photos 47
  - poll to receive 52
  - receive 50
  - receive, troubleshoot 127, 130
  - redial options 58
  - reduction 54
  - reports 60
  - reprint 52
  - resolution 48
  - rings to answer 57
  - schedule 45
  - send 41
  - send to multiple
    - recipients 45
  - send, troubleshoot 127, 129, 131
  - separate line setup (parallel phone systems) 69
  - set up 65
  - settings 47
  - settings, change 56
  - setup types 66
  - shared phone line setup (parallel phone systems) 73
  - specifications 149
  - speed 59
  - speed-dial entries, set up 28
  - speed-dial groups, set up 28
  - test failed 122
  - test setup 60
  - troubleshoot 121
  - voice mail, set up (parallel phone systems) 74
  - wall jack test, failed 123
- F**
- Fax menu 11
  - fax port, locating 9
  - firewalls, troubleshoot 109
  - fit to page 35
  - FoIP 59
  - fonts supported 147
  - forwarding faxes 53
- G**
- getting started guide 7
  - glass
    - clean 104
  - glass, scanner
    - clean 104
    - load originals 17
    - locating 8
  - grainy or white bands on copies,
    - troubleshoot 118
  - graphics
    - incompletely filled on
      - copies 117
    - ink not filling in 113
    - look different from original
      - scan 121
    - missing lines or dots 114
  - greeting cards, load 26
  - groups, speed-dial
    - set up 28
- H**
- hardware, fax setup test 122
  - header, fax 56
  - help
    - button 10
    - see *also* customer support
  - Hewlett-Packard Company
    - notices 4
  - HP Photosmart Software
    - send scans to programs 38
  - HP Solution Center 13
  - humidity specifications 149
- I**
- ink smearing, troubleshoot 113
  - installation
    - software 89
    - troubleshoot 132
- Internet**
- fax, using 59
  - ISDN line, set up with fax
    - parallel phone systems 71
- J**
- jams
    - media to avoid 18
    - paper 134, 135
  - jobs
    - settings 12
  - junk fax mode 54
- K**
- keypad 10
  - keypad, control panel
    - enter text and symbols 14
- L**
- labels
    - load 26
  - language, printer 147
  - left arrow 10
  - legal paper
    - copy 33
    - load 21
  - letter paper
    - copy 33
    - load 21
  - lid backing, clean 105
  - light images, troubleshoot
    - copies 117
    - scans 121
  - lighten
    - copies 36
    - faxes 49
  - lights, control panel 9
  - line condition test, fax 126
  - linefeed, calibrate 99
  - lines
    - copies, troubleshoot 117
    - scans, troubleshoot 120, 121
  - load
    - 10 x 15 cm photo paper 23
    - 4 x 6 inch photo paper 23
    - A4 paper 21
    - envelopes 25
    - full-size paper 21
    - greeting cards 26
    - index cards 24
    - iron-on transfers 26

- labels 26
- legal paper 21
- letter paper 21
- originals in ADF (automatic document feeder) 16
- transparencies 26

log, fax

- print 61

## M

maintenance

- align print cartridges 98
- clean glass 104
- clean lid backing 105
- clean print cartridges 99
- print cartridges 93
- replace print cartridges 94

manual faxing

- receive 51
- send 42, 43

margins

- setting, specifications 20

media

- ADF capacity 16
- duplexing 30
- HP, order 137
- load tray 1 20
- print on custom-sized 27
- selecting 18
- skewed pages 115
- specifications 19
- supported sizes 19
- troubleshoot feeding 115
- types and weights supported 20

memory

- deleting faxes 52
- reprint faxes 52
- save faxes 51

menus, control panel 11

missing lines or dots, troubleshoot 114

missing or incorrect information, troubleshoot 110

modem

- shared with fax (parallel phone systems) 75
- shared with fax and answering machine (parallel phone systems) 82

- shared with fax and voice line (parallel phone systems) 77
- shared with fax and voice mail (parallel phone systems) 87

monitor dialing 43

monitoring tools 63

multi-feeds, troubleshoot 115

## N

networks

- firewalls, troubleshoot 109

noise information 150

normal copy quality 34

number of copies 33

## O

OCR

- edit scanned documents 40
- troubleshoot 119

OK button 10

on button 9

one-touch speed dial buttons 9

operating systems

- supported 148

originals

- edit scans 39
- load ADF (automatic document feeder) 16
- scan 38

output tray

- locating 8

## P

packing the device 146

pages per month (duty cycle) 147

paper

- jams 134, 135
- legal to letter copy 35
- recommended copy types 33
- size, set for fax 54

paper size

- copy setting 33

paper-feed problems, troubleshoot 114

parallel phone systems

- answering machine setup 81
- countries/regions with 66

- distinctive ringing setup 72
- DSL setup 70
- ISDN setup 71
- modem and answering machine setup 82
- modem and voice mail setup 87
- modem setup 75
- modem shared with voice line setup 77
- PBX setup 71
- separate line setup 69
- setup types 66
- shared line setup 73

PBX system, set up with fax parallel phone systems 71

PCL 3 support 147

phone cord

- connected to correct port test failed 123
- correct type test failed 124
- extend 132

phone customer support 140

phone line, answer ring pattern 57

phone support 141

phone support period

- period for support 141

phone, fax from

- receive 51
- send, 42

photo media

- guidelines 18

photo paper

- copy 33
- load 23

photos

- edit scans 39
- enhance copies 37
- fax 47
- photo print cartridge 103

Photosmart Software

- send scans to programs 38

Photosmart Studio

- send scans to programs 38

physical specifications 147

poll to receive fax 52

ports, specifications 147

power

- specifications 150
- troubleshoot 109

power input, locating 9



## print

- cancel 31
- double-sided 30
- fax logs 61
- fax reports 60
- faxes 52
- settings 30
- slow 110
- specifications 148
- speed-dial entries 29
- troubleshoot 109

print cartridge door, locating 8

print cartridge protector 103

## print cartridges

- align 98
- clean 99
- clean contacts 100
- clean ink nozzle area 101
- handle 94
- locating 8
- order online 137
- part names 94
- part numbers 137
- photo print cartridge 103
- remove 143
- replace 94
- status 63
- store 103
- supported 93, 147
- warranty 139
- yields 147

## print driver

- settings 30
- version 140
- warranty 139

## print quality

- troubleshoot 111

print-carriage access door,

locating 8

## printer driver

- settings 30
- version 140
- warranty 139

pulse dialing 58

**Q**

quality, copy 34

quality, troubleshoot

- copy 117
- print 111
- scan 120

**R**

readme 7

rear access panel

illustration 9

receive faxes

- auto answer mode 57
- automatically 50
- blocking numbers 54
- forwarding 53
- manually 51
- polling 52
- rings to answer 57
- troubleshoot 127, 130

recycle

ink cartridges 158

redial options, setting 58

redial/pause 9

reduce fax 54

reduce/enlarge copies

- resize to fit letter 35
- resize to fit letter or A4 35

regulatory information 151

regulatory model number 157

release notes 7

remove print cartridges 143

replace print cartridges 94

reports

- confirmation, fax 61
- error, fax 61
- fax test failed 122

reprint

faxes from memory 52

resolution, fax 48

right arrow 10

rings to answer 57

**S**

save

- default settings 12
- faxes in memory 51

scan

- button 10
- cancel 40
- edit images 39
- error messages 120
- from a TWAIN- or WIA-compliant program 39
- from control panel 38
- OCR 40
- quality 120
- scan specifications 149
- send to a program 38
- settings for 40

slow 118

troubleshoot 118

Scan menu 11

scanner glass

clean 104

load originals 17

locating 8

schedule fax 45

send faxes

- basic fax 41
- color fax 47
- manually 42
- memory, from 44
- monitor dialing 43
- multiple recipients 45
- schedule 45
- troubleshoot 127, 129, 131

send scans

- for OCR 40
- to a program 38
- troubleshoot 118

serial phone systems

- countries/regions with 66
- setup types 66

Services tab, Toolbox 65

settings

- administrator 64
- control panel 12
- copy 32
- driver 30
- fax 47
- scan 40
- speed, fax 59

setup

- answering machine (parallel phone systems) 81
- answering machine and modem (parallel phone systems) 82
- button 10
- computer modem (parallel phone systems) 75
- computer modem and answering machine (parallel phone systems) 82
- computer modem and voice line (parallel phone systems) 77
- computer modem and voice mail (parallel phone systems) 87
- connection types 10

- distinctive ringing 57
  - distinctive ringing (parallel phone systems) 72
  - DSL (parallel phone systems) 70
  - fax 65
  - fax scenarios 66
  - fax, with parallel phone systems 66
  - ISDN line (parallel phone systems) 71
  - PBX system (parallel phone systems) 71
  - separate fax line (parallel phone systems) 69
  - shared phone line (parallel phone systems) 73
  - test fax 60
  - voice mail (parallel phone systems) 74
  - voice mail and computer modem (parallel phone systems) 87
  - setup poster 7
  - sharing 10
  - sharing device
    - Windows 91
  - shipping the device 143
  - size
    - scans, troubleshoot 121
    - troubleshoot copy 117
  - skew, troubleshoot
    - copy 117
    - print 115
    - scan 120
  - slow print, troubleshoot 110
  - software
    - connection types 10
    - HP Photosmart 13
    - installation 89
    - OCR 40
    - uninstall from Windows 91
    - warranty 139
  - Solution Center 13
  - sound pressure 150
  - specifications
    - acoustic emissions 150
    - electrical 150
    - media 19
    - physical 147
    - processor and memory 147
    - system requirements 148
  - speed
    - copy 34
    - troubleshoot for scanner 118
    - troubleshoot print 110
  - speed dial
    - button 9
    - fax numbers, set up 28
    - groups, set up 28
    - one-touch buttons 9
    - print and view 29
    - send fax 41
  - start black 10
  - start color 10
  - status
    - messages 12
    - supplies 63
  - streaks, troubleshoot
    - copies 117
    - scan 121
  - stripes on scans, troubleshoot 120
  - subscriber identification
    - code 56
  - supplies
    - order online 137
    - status 63
    - yields 147
  - support. *See* customer support
  - support process 140
  - symbols, enter 14
  - system requirements 148
- T**
- technical information
    - copy specifications 148
    - fax specifications 149
    - physical specifications 147
    - print specifications 148
    - scan specifications 149
    - weight 147
  - telephone customer support 140
  - telephone line, answer ring pattern 57
  - telephone wall jack, fax 123
  - telephone, fax from
    - receive 51
    - send 42
  - temperature specifications 149
  - tests, fax
    - dial tone, failed 125
    - failed 122
  - fax line condition 126
  - fax phone cord type test
    - failed 124
  - hardware, failed 122
  - port connection, failed 123
  - setup 60
  - telephone wall jack 123
- text
- cannot be edited after scan, troubleshoot 119
  - enhance on copies 36
  - enter from control panel 14
  - incompletely filled on
    - copies 117
  - missing from scan, troubleshoot 119
  - splotchy on copies 118
  - troubleshoot 111, 113, 114
  - unclear on copies, troubleshoot 117
  - unclear scans 121
- tone dialing 58
- Toolbox
- about 64
  - Estimated Ink Level tab 65
  - opening 64
  - Services tab 65
- Toolbox (Windows)
- administrator settings 64
- transparencies
  - copy 33
  - load 26
- trays
- capacities 20
  - load media 20
  - locating 8
  - media sizes supported 19
  - media types and weights supported 20
  - paper guides illustration 8
  - troubleshoot feeding 115
- troubleshoot
- answering machines 132
  - blank pages printed 110
  - bleeding colors 114
  - colors 113, 114
  - control panel messages 11
  - copy 116
  - copy quality 117
  - cut-off pages, incorrect text or graphics placement 111
  - fax 121

## Index

- fax dial tone test failed 125
- fax hardware test failed 122
- fax line test failed 126
- fax phone cord connection
  - test failed 123
- fax phone cord type test
  - failed 124
- fax tests 122
- fax wall jack test, failed 123
- firewalls 109
- ink not filling text or graphics 113
- ink smearing 113
- installation 132
- jams, paper 135
- meaningless characters
  - print 112
- media not picked up from tray 115
- missing lines or dots 114
- missing or incorrect information 110
- multiple pages are picked 115
- nothing prints 109
- paper-feed problems 114
- power 109
- print 109
- print quality 111
- receive faxes 127, 130
- scan 118
- scan quality 120
- send faxes 127, 129, 131
- skewed copies 117
- skewed pages 115
- slow print 110
- tips 108

**TWAIN**

- scan from 39
- unable to activate
  - source 120

two-sided printing 30

## U

- uninstall software
  - Windows 91
- USB connection
  - features available 10
  - port, locating 8, 9
  - setup Windows 89
  - specifications 147

## V

- vertical stripes on copies,
  - troubleshoot 117
- view
  - speed-dial entries 29
- voice mail
  - set up with fax (parallel phone systems) 74
  - set up with fax and computer modem (parallel phone systems) 87
- voltage specifications 150

## W

- wall jack test, fax 123
- warning messages 12
- warranty 139, 143
- Web sites
  - accessibility information 4
  - customer support 140
  - environmental programs 158
  - European print cartridges 137
  - order supplies 137
  - supply yield data sheet 147
- white bands or stripes,
  - troubleshoot
    - copies 117, 118
    - scans 120
- WIA (Windows Image Application), scan from 39
- Windows
  - duplexing 31
  - install software 89
  - print settings 30
  - system requirements 148
- Windows Image Application (WIA), scan from 39





© 2007 Hewlett-Packard Development Company, L.P.

[www.hp.com/support](http://www.hp.com/support)

