



# XP-6100 Series

# User's Guide

## Copyright

# Copyright

No part of this publication may be reproduced, stored in a retrieval system, or transmitted in any form or by any means, electronic, mechanical, photocopying, recording, or otherwise, without the prior written permission of Seiko Epson Corporation. No patent liability is assumed with respect to the use of the information contained herein. Neither is any liability assumed for damages resulting from the use of the information herein. The information contained herein is designed only for use with this Epson product. Epson is not responsible for any use of this information as applied to other products.

Neither Seiko Epson Corporation nor its affiliates shall be liable to the purchaser of this product or third parties for damages, losses, costs, or expenses incurred by the purchaser or third parties as a result of accident, misuse, or abuse of this product or unauthorized modifications, repairs, or alterations to this product, or (excluding the U.S.) failure to strictly comply with Seiko Epson Corporation's operating and maintenance instructions.

Seiko Epson Corporation and its affiliates shall not be liable for any damages or problems arising from the use of any options or any consumable products other than those designated as Original Epson Products or Epson Approved Products by Seiko Epson Corporation.

Seiko Epson Corporation shall not be held liable for any damage resulting from electromagnetic interference that occurs from the use of any interface cables other than those designated as Epson Approved Products by Seiko Epson Corporation.

© 2018 Seiko Epson Corporation

The contents of this manual and the specifications of this product are subject to change without notice.

# Trademarks

- EPSON® is a registered trademark, and EPSON EXCEED YOUR VISION or EXCEED YOUR VISION is a trademark of Seiko Epson Corporation.
- PRINT Image Matching™ and the PRINT Image Matching logo are trademarks of Seiko Epson Corporation. Copyright © 2001 Seiko Epson Corporation. All rights reserved.
- Epson Scan 2 software is based in part on the work of the Independent JPEG Group.
- libtiff

Copyright © 1988-1997 Sam Leffler

Copyright © 1991-1997 Silicon Graphics, Inc.

Permission to use, copy, modify, distribute, and sell this software and its documentation for any purpose is hereby granted without fee, provided that (i) the above copyright notices and this permission notice appear in all copies of the software and related documentation, and (ii) the names of Sam Leffler and Silicon Graphics may not be used in any advertising or publicity relating to the software without the specific, prior written permission of Sam Leffler and Silicon Graphics.

THE SOFTWARE IS PROVIDED "AS-IS" AND WITHOUT WARRANTY OF ANY KIND, EXPRESS, IMPLIED OR OTHERWISE, INCLUDING WITHOUT LIMITATION, ANY WARRANTY OF MERCHANTABILITY OR FITNESS FOR A PARTICULAR PURPOSE.

IN NO EVENT SHALL SAM LEFFLER OR SILICON GRAPHICS BE LIABLE FOR ANY SPECIAL, INCIDENTAL, INDIRECT OR CONSEQUENTIAL DAMAGES OF ANY KIND, OR ANY DAMAGES WHATSOEVER RESULTING FROM LOSS OF USE, DATA OR PROFITS, WHETHER OR NOT ADVISED OF THE POSSIBILITY OF DAMAGE, AND ON ANY THEORY OF LIABILITY, ARISING OUT OF OR IN CONNECTION WITH THE USE OR PERFORMANCE OF THIS SOFTWARE.

- SDXC Logo is a trademark of SD-3C, LLC.



- PictBridge is a trademark.



- QR Code is a registered trademark of DENSO WAVE INCORPORATED in Japan and other countries.
- Intel® is a registered trademark of Intel Corporation.
- Microsoft®, Windows®, and Windows Vista® are registered trademarks of Microsoft Corporation.
- Apple, Macintosh, macOS, OS X, Bonjour, ColorSync, Safari, AirPrint, the AirPrint Logo, iPad, iPhone, iPod touch, and iTunes are trademarks of Apple Inc., registered in the U.S. and other countries.
- Google Cloud Print, Chrome, Chrome OS, Google Play and Android are trademarks of Google Inc.
- Adobe and Adobe Reader are either registered trademarks or trademarks of Adobe Systems Incorporated in the United States and/or other countries.

## Trademarks

- ❑ General Notice: Other product names used herein are for identification purposes only and may be trademarks of their respective owners. Epson disclaims any and all rights in those marks.

## Contents

### Copyright

### Trademarks

### About This Manual

Introduction to the Manuals. . . . .	10
Using the Manual to Search for Information. . . . .	10
Marks and Symbols. . . . .	11
Descriptions Used in this Manual. . . . .	12
Operating System References. . . . .	12

### Important Instructions

Safety Instructions. . . . .	13
Printer Advisories and Warnings. . . . .	14
Advisories and Warnings for Setting Up/ Using the Printer. . . . .	14
Advisories and Warnings for Using the Printer with a Wireless Connection. . . . .	15
Advisories and Warnings for Using Memory Cards. . . . .	15
Advisories and Warnings for Using the LCD Screen. . . . .	15
Protecting Your Personal Information. . . . .	15

### Printer Basics

Part Names and Functions. . . . .	16
Control Panel. . . . .	19
Icons displayed in the LCD Screen. . . . .	19
Basic Screen Configuration. . . . .	22
Entering Characters. . . . .	23
Viewing Animations. . . . .	24
Displaying a Menu Appropriate to the Operation. . . . .	25

### Network Settings

Network Connection Types. . . . .	26
Wi-Fi Connection. . . . .	26
Wi-Fi Direct (Simple AP) Connection. . . . .	26
Connecting to a Computer. . . . .	27
Connecting to a Smart Device. . . . .	28
Connecting to a smart device over a wireless router. . . . .	28

Connecting to an iPhone or iPad (iOS devices) using Wi-Fi Direct. . . . .	28
Connecting to Android Devices Using Wi-Fi Direct. . . . .	32
Connecting to Devices other than iOS and Android Using Wi-Fi Direct. . . . .	34
Making Wi-Fi Settings from the Printer. . . . .	37
Making Wi-Fi Settings by Entering the SSID and Password. . . . .	38
Making Wi-Fi Settings by Push Button Setup (WPS). . . . .	39
Making Wi-Fi Settings by PIN Code Setup (WPS). . . . .	41
Making Wi-Fi Direct (Simple AP) Connection Settings. . . . .	42
Making Advanced Network Settings. . . . .	43
Checking the Network Connection Status. . . . .	44
Network Icon. . . . .	44
Checking Detailed Network Information from the Control Panel. . . . .	44
Printing a Network Connection Report. . . . .	45
Printing a Network Status Sheet. . . . .	51
Replacing or Adding New Wireless Routers. . . . .	52
Changing the Connection Method to a Computer. . . . .	52
Changing the Wi-Fi Direct (Simple AP) Settings. . . . .	53
Disabling Wi-Fi from the Control Panel. . . . .	53
Disconnecting Wi-Fi Direct (Simple AP) Connection from the Control Panel. . . . .	54
Restoring the Network Settings from the Control Panel. . . . .	55

### Loading Paper

Paper Handling Precautions. . . . .	57
Available Paper and Capacities. . . . .	58
Genuine Epson Paper. . . . .	58
Commercially Available Paper. . . . .	60
List of Paper Types. . . . .	60
Paper Source Features. . . . .	61
Loading Paper in the Paper Cassette 1. . . . .	62
Loading Paper in the Paper Cassette 2. . . . .	66

### Placing Originals

Placing Originals on the Scanner Glass. . . . .	72
How to Place Various Originals. . . . .	73
Placing Photos for Copying. . . . .	73
Placing an ID Card for Copying. . . . .	74

## Contents

Placing a CD/DVD for Copying Labels. . . . .	74	Printing from Smart Devices. . . . .	120
Placing Multiple Photos for Scanning at the Same Time. . . . .	74	Using Epson iPrint. . . . .	120
		Using Epson Print Enabler. . . . .	122
		Using AirPrint. . . . .	122
<b>Inserting a Memory Card</b>		Printing from a Digital Camera. . . . .	123
Supported Memory Cards. . . . .	76	Printing from a Digital Camera Connected by USB Cable. . . . .	123
Inserting and Removing a Memory Card. . . . .	76	Printing from a Digital Camera Connected Wirelessly. . . . .	124
<b>Loading a CD/DVD for Printing</b>		Canceling Printing. . . . .	125
Printable CD/DVDs. . . . .	78	Canceling Printing - Control Panel. . . . .	125
CD/DVD Handling Precautions. . . . .	78	Canceling Printing - Windows. . . . .	125
Loading and Removing a CD/DVD. . . . .	78	Canceling Printing - Mac OS. . . . .	126
<b>Printing</b>		<b>Copying</b>	
Printing from the <b>Print Photos</b> Menu on the Control Panel. . . . .	80	Copying Basics. . . . .	127
Basic Operations for Printing Photos. . . . .	80	Various Copying Methods. . . . .	128
Printing in Various Layouts. . . . .	84	Copying in Various Layout. . . . .	128
Printing ID Photos. . . . .	85	Copying Photos. . . . .	129
Printing Photos with a Template. . . . .	86	Copying on a CD/DVD Label. . . . .	130
Menu Options for Printing from the Control Panel. . . . .	87	Menu Options for Copying. . . . .	133
Printing from the <b>Various prints</b> Menu on the Control Panel. . . . .	90	<b>Scanning</b>	
Printing Design Paper. . . . .	90	Scanning Using the Control Panel. . . . .	135
Printing Photos with Handwritten Notes. . . . .	91	Scanning to a Memory Device. . . . .	135
Printing Photos onto a CD/DVD Label. . . . .	93	Scanning to a Computer. . . . .	137
Printing Photos onto a Jewel Case Jacket. . . . .	95	Scanning to the Cloud. . . . .	141
Printing Original Calendars with a Photo. . . . .	96	Scanning Using WSD. . . . .	143
Printing a Schedule. . . . .	97	Scanning from a Computer. . . . .	145
Printing Lined Paper. . . . .	98	Scanning Using Epson Scan 2. . . . .	145
Printing Original Writing Paper. . . . .	98	Scanning from Smart Devices. . . . .	152
Printing an Original Message Card. . . . .	99	Installing Epson iPrint. . . . .	152
Printing a Coloring Book. . . . .	101	Scanning Using Epson iPrint. . . . .	152
Printing from a Computer. . . . .	101	<b>Replacing Ink Cartridges and Other Consumables</b>	
Printing Basics - Windows. . . . .	101	Checking the Status of the Remaining Ink and the Maintenance Box. . . . .	154
Printing Basics - Mac OS. . . . .	103	Checking the Status of the Remaining Ink and the Maintenance Box - Control Panel. . . . .	154
Printing on 2-Sides. . . . .	105	Checking the Status of the Remaining Ink and the Maintenance Box - Windows. . . . .	154
Printing Several Pages on One Sheet. . . . .	107	Checking the Status of the Remaining Ink and the Maintenance Box - Mac OS. . . . .	154
Printing to Fit the Paper Size. . . . .	109	Ink Cartridge Codes. . . . .	155
Printing Multiple Files Together (for Windows Only). . . . .	110	Ink Cartridge Handling Precautions. . . . .	156
Printing One Image on Multiple Sheets to Create a Poster (for Windows Only). . . . .	111	Replacing Ink Cartridges. . . . .	158
Printing Using Advanced Features. . . . .	117		
Printing Photos Using Epson Easy Photo Print. . . . .	119		
Printing a CD/DVD Label with Epson Print CD. . . . .	120		

## Contents

Maintenance Box Code. . . . .	162	Clear All Settings. . . . .	182
Maintenance Box Handling Precautions. . . . .	162	Menu Options for Network Settings. . . . .	182
Replacing a Maintenance Box. . . . .	163	Menu Options for Web Service Settings. . . . .	183
Temporarily Printing with Black Ink. . . . .	166	Menu Options for File Sharing Setup. . . . .	184
Temporarily Printing with Black Ink - Windows	167	Menu Options for Camera Print Settings. . . . .	184
Temporarily Printing with Black Ink - Mac OS.	168	Menu Options for Guide Functions. . . . .	184
Conserving Black Ink when the Black Ink Is		Paper Mismatch:. . . . .	184
Low (for Windows Only). . . . .	169	Auto Selection Mode:. . . . .	184
		All settings:. . . . .	185
		Clear All Settings:. . . . .	185
		Menu Options for Firmware Update. . . . .	185
		Update:. . . . .	185
		Notification:. . . . .	185
		Menu Options for Restore Default Settings. . . . .	185
<b>Maintaining the Printer</b>		<b>Network Service and Software</b>	
Checking and Cleaning the Print Head. . . . .	170	<b>Information</b>	
Checking and Cleaning the Print Head -		Epson Connect Service. . . . .	186
Control Panel. . . . .	170	Registering to Epson Connect Service from	
Checking and Cleaning the Print Head -		the Control Panel. . . . .	186
Windows. . . . .	171	Application for Configuring Printer Operations	
Checking and Cleaning the Print Head - Mac		(Web Config). . . . .	186
OS. . . . .	171	Running Web Config on a Web Browser. . . . .	187
Aligning the Print Head. . . . .	171	Running Web Config on Windows. . . . .	187
Aligning the Print Head - Control Panel. . . . .	172	Running Web Config on Mac OS. . . . .	188
Cleaning the Paper Path. . . . .	172	Windows Printer Driver. . . . .	188
Cleaning the Paper Path for Ink Smears. . . . .	173	Guide to Windows Printer Driver. . . . .	189
Cleaning the Paper Path for Paper Feeding		Making Operation Settings for the Windows	
Problems. . . . .	174	Printer Driver. . . . .	191
Cleaning the Scanner Glass. . . . .	176	Mac OS Printer Driver. . . . .	191
Cleaning the Translucent Film. . . . .	176	Guide to Mac OS Printer Driver. . . . .	192
Saving Power. . . . .	178	Making Operation Settings for the Mac OS	
Saving Power - Control Panel. . . . .	178	Printer Driver. . . . .	193
		Application for Scanning Documents and	
		Images (Epson Scan 2). . . . .	194
		Adding the Network Scanner. . . . .	195
		Application for Configuring Scanning	
		Operations from the Control Panel (Epson	
		Event Manager). . . . .	195
		Application for Laying Out Photos (Epson Easy	
		Photo Print). . . . .	196
		Application for Printing Text or Images on a	
		Disc (Epson Print CD). . . . .	196
		Application for Printing Web Pages (E-Web Print)	197
		Application for Scanning and Transferring	
		Images (Easy Photo Scan). . . . .	197
		Software Update Tools (EPSON Software	
		Updater). . . . .	198
<b>Menu Options for Settings</b>			
Menu Options for Supply Status. . . . .	180		
Menu Options for Basic Settings. . . . .	180		
Screen Saver:. . . . .	180		
LCD Brightness:. . . . .	180		
Auto Power On:. . . . .	180		
Power Off Timer:. . . . .	180		
Power Off Settings:. . . . .	181		
Sleep Timer:. . . . .	181		
Language:. . . . .	181		
Clear All Settings:. . . . .	181		
Menu Options for Printer Settings. . . . .	181		
Paper Source Setting:. . . . .	181		
CD/DVD:. . . . .	181		
CD Inner/Outer:. . . . .	182		
Stickers:. . . . .	182		
Thick Paper:. . . . .	182		
Quiet Mode:. . . . .	182		
Ink Drying Time:. . . . .	182		
Bidirectional:. . . . .	182		

## Contents

Installing Applications. . . . .	198	Blurry Prints, Vertical Banding, or Misalignment. . . . .	221
Updating Applications and Firmware. . . . .	199	Print Quality is Poor. . . . .	222
Updating the Printer's Firmware using the Control Panel. . . . .	199	Paper Is Smearred or Scuffed. . . . .	223
Uninstalling Applications. . . . .	200	Paper is Smearred During Automatic 2-Sided Printing. . . . .	224
Uninstalling Applications - Windows. . . . .	200	Printed Photos are Sticky. . . . .	224
Uninstalling Applications - Mac OS. . . . .	201	Images or Photos are Printed in Unexpected Colors. . . . .	224
<b>Solving Problems</b>		Colors Differ from What You See on the Display. . . . .	225
Checking the Printer Status. . . . .	202	Cannot Print Without Margins. . . . .	225
Checking Messages on the LCD Screen. . . . .	202	Edges of the Image are Cropped During Borderless Printing. . . . .	225
Checking the Printer Status - Windows. . . . .	204	The Position, Size, or Margins of the Printout Are Incorrect. . . . .	226
Checking the Printer Status - Mac OS. . . . .	205	Multiple Originals are Copied onto a Single Sheet. . . . .	226
Removing Jammed Paper. . . . .	205	Printing Position of Photo Stickers is Incorrect. . . . .	226
Removing Jammed Paper from Inside the Printer. . . . .	205	The Printing or Copying Position on a CD/DVD is Incorrect. . . . .	227
Removing Jammed Paper from Rear Cover. . . . .	207	Printed Characters Are Incorrect or Garbled. . . . .	227
Removing Jammed Paper from the Paper Cassette. . . . .	208	The Printed Image Is Inverted. . . . .	227
Paper Does Not Feed Correctly. . . . .	209	Mosaic-Like Patterns in the Prints. . . . .	228
Paper Jams. . . . .	210	Uneven Colors, Smears, Dots, or Straight Lines Appear in the Copied Image. . . . .	228
Paper Feeds at a Slant. . . . .	210	Moiré (Cross-Hatch) Patterns Appear in the Copied Image. . . . .	228
Several Sheets of Paper are Fed at a Time. . . . .	210	An Image of the Reverse Side of the Original Appears in the Copied Image. . . . .	228
CD/DVD Tray is Ejected. . . . .	210	The Printout Problem Could Not be Cleared. . . . .	228
Power and Control Panel Problems. . . . .	210	Other Printing Problems. . . . .	229
Power Does Not Turn On. . . . .	210	Printing Is Too Slow. . . . .	229
Power Does Not Turn Off. . . . .	211	Printing Slows Down Dramatically During Continuous Printing. . . . .	230
Power Turns Off Automatically. . . . .	211	Cannot Cancel Printing from a Computer Running Mac OS X v10.6.8. . . . .	230
LCD Screen Gets Dark. . . . .	211	Cannot Start Scanning. . . . .	230
The Auto Power On Features does not Work. . . . .	211	Cannot Start Scanning when Using the Control Panel. . . . .	231
Cannot Print from a Computer. . . . .	211	Scanned Image Problems. . . . .	231
Checking the Connection (USB). . . . .	211	Uneven Colors, Dirt, Spots, and so on Appear when Scanning from the Scanner Glass. . . . .	231
Checking the Connection (Network). . . . .	212	The Image Quality Is Rough. . . . .	231
Checking the Software and Data. . . . .	213	Offset Appears in the Background of Images. . . . .	231
Checking the Printer Status from the Computer (Windows). . . . .	215	Text is Blurred. . . . .	232
Checking the Printer Status from the Computer (Mac OS). . . . .	216	Moiré Patterns (Web-Like Shadows) Appear. . . . .	232
When You Cannot Make Network Settings. . . . .	216	Cannot Scan the Correct Area on the Scanner Glass. . . . .	233
Cannot Connect from Devices Even Though Network Settings are No Problems. . . . .	216	Cannot Preview in Thumbnail. . . . .	233
Checking the SSID Connected to the Printer. . . . .	218	Text is Not Recognized Correctly when Saving as a Searchable PDF. . . . .	233
Checking the SSID for the Computer. . . . .	219		
Cannot Print from an iPhone or iPad. . . . .	220		
Printout Problems. . . . .	220		
Printout is Scuffed or Color is Missing. . . . .	220		
Banding or Unexpected Colors Appear. . . . .	220		
Colored Banding Appears at Intervals of Approximately 2.5 cm. . . . .	221		



## Contents

Cannot Solve Problems in the Scanned Image. . . . .	234
Other Scanning Problems. . . . .	234
Scanning Speed Is Slow. . . . .	234
Scanning Stops when Scanning to PDF/ Multi-TIFF. . . . .	235
Other Problems. . . . .	235
Slight Electric Shock when Touching the Printer. . . . .	235
Operation Sounds Are Loud. . . . .	235
Cannot Save Data to a Memory Device. . . . .	235
Application Is Blocked by a Firewall (for Windows Only). . . . .	236
"! " Is Displayed on the Photo Selection Screen. . . . .	236

## Appendix

Technical Specifications. . . . .	237
Printer Specifications. . . . .	237
Scanner Specifications. . . . .	238
Interface Specifications. . . . .	239
Network Function List. . . . .	239
Wi-Fi Specifications. . . . .	240
Security Protocol. . . . .	240
Supported Third Party Services. . . . .	240
External Storage Device Specifications. . . . .	240
Supported Data Specifications. . . . .	241
Dimensions. . . . .	242
Electrical Specifications. . . . .	242
Environmental Specifications. . . . .	243
System Requirements. . . . .	243
Regulatory Information. . . . .	244
Standards and Approvals. . . . .	244
Restrictions on Copying. . . . .	245
Transporting and Storing the Printer. . . . .	245
Accessing a Memory Card From a Computer. . . . .	248
Where to Get Help. . . . .	249
Technical Support Web Site. . . . .	249
Contacting Epson Support. . . . .	249

# About This Manual

## Introduction to the Manuals

The following manuals are supplied with your Epson printer. As well as the manuals, check the various types of help information available from the printer itself or from the Epson software applications.

### ❑ Start Here (paper manual)

Provides you with information on setting up the printer, installing the software, using the printer, solving problems, and so on.

### ❑ User's Guide (digital manual)

This manual. Provides overall information and instructions on using the printer, on network settings when using the printer on a network, and on solving problems.

You can obtain the latest versions of the above manuals with the following methods.

### ❑ Paper manual

Visit the Epson Europe support website at <http://www.epson.eu/Support>, or the Epson worldwide support website at <http://support.epson.net/>.

### ❑ Digital manual

Start EPSON Software Updater on your computer. EPSON Software Updater checks for available updates of Epson software applications and the digital manuals, and allows you to download the latest ones.

## Related Information

➔ “Software Update Tools (EPSON Software Updater)” on page 198

## Using the Manual to Search for Information

The PDF manual allows you to search for information you are looking for by keyword, or jump directly to specific sections using the bookmarks. You can also print only the pages you need. This section explains how to use a PDF manual that has been opened in Adobe Reader X on your computer.

### Searching by keyword

Click **Edit > Advanced Search**. Enter the keyword (text) for information you want to find in the search window, and then click **Search**. Hits are displayed as a list. Click one of the displayed hits to jump to that page.

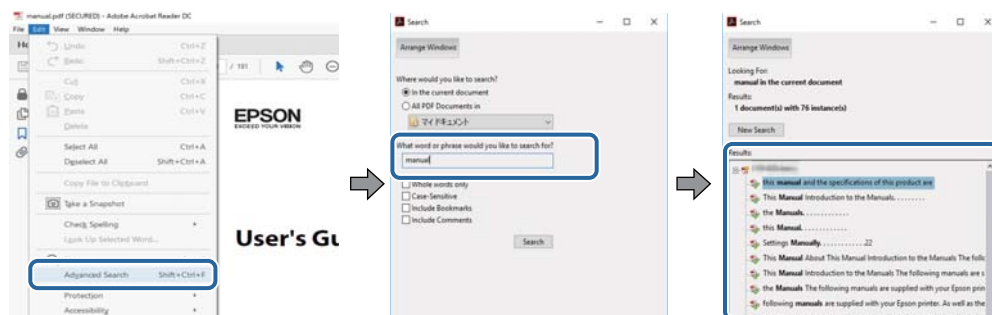

## About This Manual

### Jumping directly from bookmarks

Click a title to jump to that page. Click + or > to view the lower level titles in that section. To return to the previous page, perform the following operation on your keyboard.

- ❑ Windows: Hold down **Alt**, and then press **←**.
- ❑ Mac OS: Hold down the command key, and then press **←**.

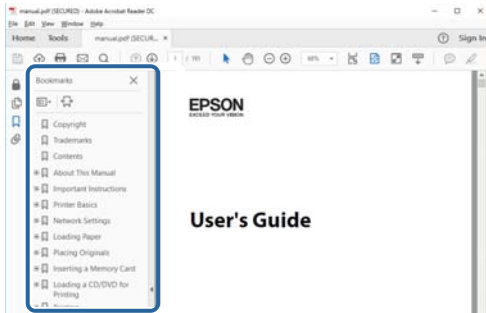

### Printing only the pages you need

You can extract and print only the pages you need. Click **Print** in the **File** menu, and then specify the pages you want to print in **Pages in Pages to Print**.

- ❑ To specify a series of pages, enter a hyphen between the start page and the end page.  
Example: 20-25
- ❑ To specify pages that are not in series, divide the pages with commas.  
Example: 5, 10, 15

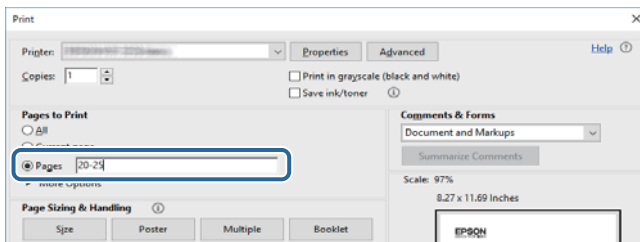

---

## Marks and Symbols



### Caution:

*Instructions that must be followed carefully to avoid bodily injury.*



### Important:

*Instructions that must be observed to avoid damage to your equipment.*

### Note:

*Provides complementary and reference information.*

## About This Manual

### Related Information

➔ Links to related sections.

---

## Descriptions Used in this Manual

- Screenshots of the printer driver and the Epson Scan 2 (scanner driver) screens are from Windows 10 or macOS High Sierra. The content displayed on the screens varies depending on the model and situation.
- Illustrations used in this manual are examples only. Although there may be slight differences depending on the model, the method of operation is the same.
- Some of the menu items on the LCD screen vary depending on the model and settings.
- You can read the QR code using dedicated app.

---

## Operating System References

### Windows

In this manual, terms such as "Windows 10", "Windows 8.1", "Windows 8", "Windows 7", "Windows Vista", and "Windows XP" refer to the following operating systems. Additionally, "Windows" is used to refer to all versions.

- Microsoft® Windows® 10 operating system
- Microsoft® Windows® 8.1 operating system
- Microsoft® Windows® 8 operating system
- Microsoft® Windows® 7 operating system
- Microsoft® Windows Vista® operating system
- Microsoft® Windows® XP operating system
- Microsoft® Windows® XP Professional x64 Edition operating system

### Mac OS

In this manual, "Mac OS" is used to refer to macOS High Sierra, macOS Sierra, OS X El Capitan, OS X Yosemite, OS X Mavericks, OS X Mountain Lion, Mac OS X v10.7.x, and Mac OS X v10.6.8.

# Important Instructions

---

## Safety Instructions

Read and follow these instructions to ensure safe use of this printer. Make sure you keep this manual for future reference. Also, be sure to follow all warnings and instructions marked on the printer.



- ❑ Some of the symbols used on your printer are to ensure safety and proper use of the printer. Visit the following Web site to learn the meaning of the symbols.  
<http://support.epson.net/symbols>
- ❑ Use only the power cord supplied with the printer and do not use the cord with any other equipment. Use of other cords with this printer or the use of the supplied power cord with other equipment may result in fire or electric shock.
- ❑ Be sure your AC power cord meets the relevant local safety standard.
- ❑ Never disassemble, modify, or attempt to repair the power cord, plug, printer unit, scanner unit, or options by yourself, except as specifically explained in the printer's manuals.
- ❑ Unplug the printer and refer servicing to qualified service personnel under the following conditions:  
The power cord or plug is damaged; liquid has entered the printer; the printer has been dropped or the casing damaged; the printer does not operate normally or exhibits a distinct change in performance. Do not adjust controls that are not covered by the operating instructions.
- ❑ Place the printer near a wall outlet where the plug can be easily unplugged.
- ❑ Do not place or store the printer outdoors, near excessive dirt or dust, water, heat sources, or in locations subject to shocks, vibrations, high temperature or humidity.
- ❑ Take care not to spill liquid on the printer and not to handle the printer with wet hands.
- ❑ Keep the printer at least 22 cm away from cardiac pacemakers. Radio waves from this printer may adversely affect the operation of cardiac pacemakers.
- ❑ If the LCD screen is damaged, contact your dealer. If the liquid crystal solution gets on your hands, wash them thoroughly with soap and water. If the liquid crystal solution gets into your eyes, flush them immediately with water. If discomfort or vision problems remain after a thorough flushing, see a doctor immediately.
- ❑ Be careful when you handle used ink cartridges, as there may be some ink around the ink supply port.
  - ❑ If ink gets on your skin, wash the area thoroughly with soap and water.
  - ❑ If ink gets into your eyes, flush them immediately with water. If discomfort or vision problems continue after a thorough flushing, see a doctor immediately.
  - ❑ If ink gets into your mouth, see a doctor right away.
- ❑ Do not disassemble the ink cartridge and the maintenance box; otherwise ink may get into your eyes or on your skin.
- ❑ Do not shake ink cartridges too vigorously and do not drop them. Also, be careful not to squeeze them or tear their labels. Doing so may cause ink leakage.
- ❑ Keep ink cartridges and maintenance box out of the reach of children.

---

## Printer Advisories and Warnings

Read and follow these instructions to avoid damaging the printer or your property. Make sure you keep this manual for future reference.

### Advisories and Warnings for Setting Up/Using the Printer

- Do not block or cover the vents and openings in the printer.
- Use only the type of power source indicated on the printer's label.
- Avoid using outlets on the same circuit as photocopiers or air control systems that regularly switch on and off.
- Avoid electrical outlets controlled by wall switches or automatic timers.
- Keep the entire computer system away from potential sources of electromagnetic interference, such as loudspeakers or the base units of cordless telephones.
- The power-supply cords should be placed to avoid abrasions, cuts, fraying, crimping, and kinking. Do not place objects on top of the power-supply cords and do not allow the power-supply cords to be stepped on or run over. Be particularly careful to keep all the power-supply cords straight at the ends and the points where they enter and leave the transformer.
- If you use an extension cord with the printer, make sure that the total ampere rating of the devices plugged into the extension cord does not exceed the cord's ampere rating. Also, make sure that the total ampere rating of all devices plugged into the wall outlet does not exceed the wall outlet's ampere rating.
- If you plan to use the printer in Germany, the building installation must be protected by a 10 or 16 amp circuit breaker to provide adequate short-circuit protection and over-current protection for the printer.
- When connecting the printer to a computer or other device with a cable, ensure the correct orientation of the connectors. Each connector has only one correct orientation. Inserting a connector in the wrong orientation may damage both devices connected by the cable.
- Place the printer on a flat, stable surface that extends beyond the base of the printer in all directions. The printer will not operate properly if it is tilted at an angle.
- When storing or transporting the printer, avoid tilting it, placing it vertically, or turning it upside down; otherwise ink may leak.
- Allow space above the printer so that you can fully raise the document cover.
- Leave enough space in front of the printer for the paper to be fully ejected.
- Avoid places subject to rapid changes in temperature and humidity. Also, keep the printer away from direct sunlight, strong light, or heat sources.
- Do not insert objects through the slots in the printer.
- Do not put your hand inside the printer during printing.
- Do not touch the white flat cable inside the printer.
- Do not use aerosol products that contain flammable gases inside or around the printer. Doing so may cause fire.
- Do not move the print head by hand; otherwise, you may damage the printer.
- Be careful not to trap your fingers when closing the scanner unit.
- Do not press too hard on the scanner glass when placing the originals.
- Always turn the printer off using the  button. Do not unplug the printer or turn off the power at the outlet until the  light stops flashing.

## Important Instructions

- ❑ Before transporting the printer, make sure that the print head is in the home (far right) position and the ink cartridges are in place.
- ❑ If you are not going to use the printer for a long period, be sure to unplug the power cord from the electrical outlet.

## Advisories and Warnings for Using the Printer with a Wireless Connection

- ❑ Radio waves from this printer may negatively affect the operation of medical electronic equipment, causing them to malfunction. When using this printer inside medical facilities or near medical equipment, follow directions from the authorized personnel representing the medical facilities, and follow all posted warnings and directions on the medical equipment.
- ❑ Radio waves from this printer may negatively affect the operation of automatically controlled devices such as automatic doors or fire alarms, and could lead to accidents due to malfunction. When using this printer near automatically controlled devices, follow all posted warnings and directions on these devices.

## Advisories and Warnings for Using Memory Cards

- ❑ Do not remove a memory card or turn off the printer while the memory card light is flashing.
- ❑ The methods for using memory cards vary according to card type. Be sure to refer to the manual packaged with your memory card for details.
- ❑ Use only memory cards compatible with the printer.

### Related Information

- ➔ [“Supported Memory Card Specifications” on page 240](#)

## Advisories and Warnings for Using the LCD Screen

- ❑ The LCD screen may contain a few small bright or dark spots, and because of its features it may have an uneven brightness. These are normal and do not indicate that it is damaged in any way.
- ❑ Only use a dry, soft cloth for cleaning. Do not use liquid or chemical cleaners.
- ❑ The exterior cover of the LCD screen could break if it receives a heavy impact. Contact your dealer if the screen's surface chips or cracks, and do not touch or attempt to remove the broken pieces.

---

## Protecting Your Personal Information

When you give the printer to someone else or dispose of it, erase all the personal information stored in the printer's memory by selecting **Settings > Restore Default Settings > All Settings** on the control panel.

# Printer Basics

## Part Names and Functions

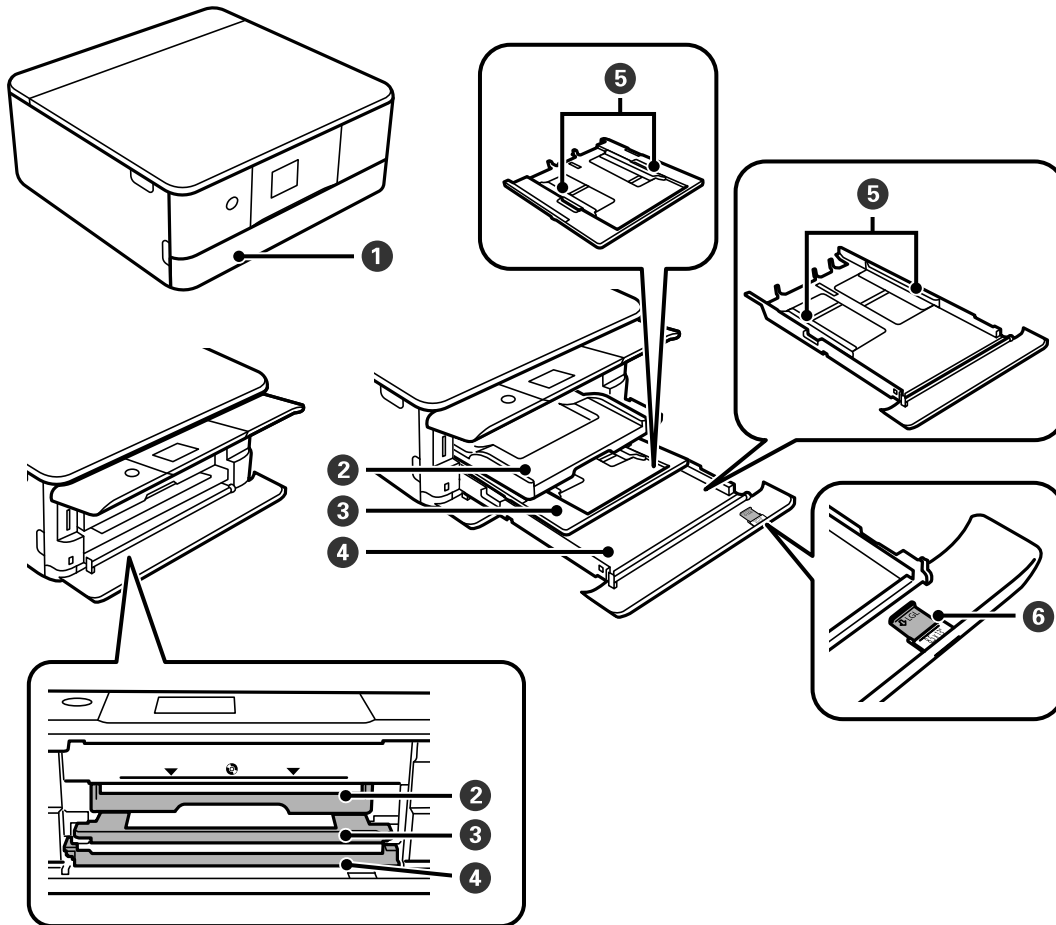

<b>1</b>	Front cover	Open to load paper in the paper cassette.
<b>2</b>	Output tray	Holds the ejected paper. Slide out manually and push it back in to store.
<b>3</b>	Paper cassette 1	Loads paper.
<b>4</b>	Paper cassette 2	When printing using Epson iPrint, make sure that the number printed on the right side of the paper cassette matches the paper source setting in Epson iPrint.
<b>5</b>	Edge guide	Feeds the paper straight into the printer. Slide to the edges of the paper.
<b>6</b>	paper guide extension	Slide out to load legal size paper.



**Printer Basics**

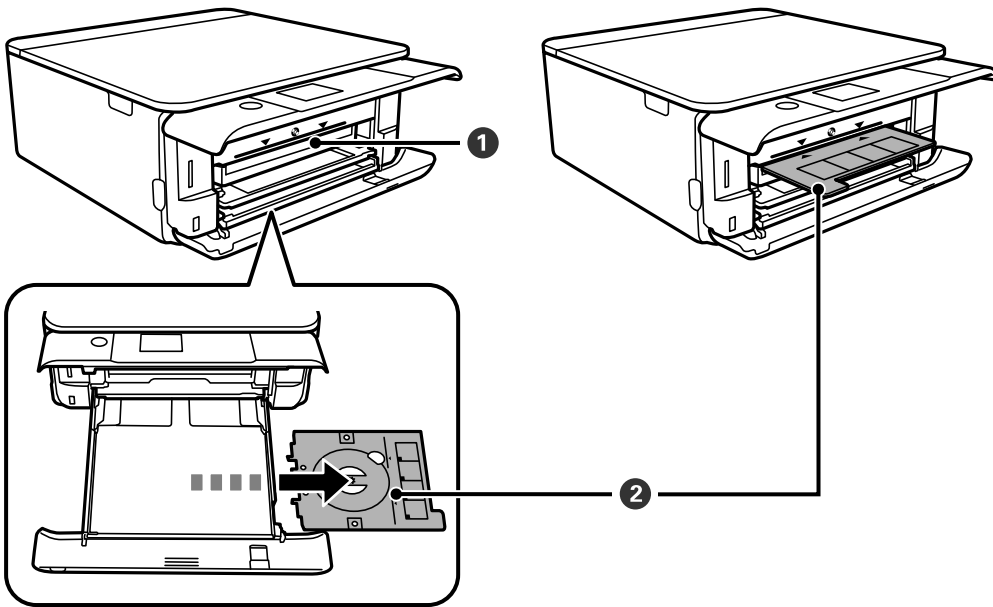

<p>❶</p>	<p>CD/DVD tray slot</p>	<p>Insert the CD/DVD tray with a CD/DVD placed on it for label printing into this slot.</p>
<p>❷</p>	<p>CD/DVD tray</p>	<p>When printing on a CD/DVD, remove this from the bottom of the printer, place a CD/DVD, and insert it into the CD/DVD tray slot.</p> <p>When not printing on a CD/DVD, store it in the bottom of the printer without placing a CD/DVD.</p>

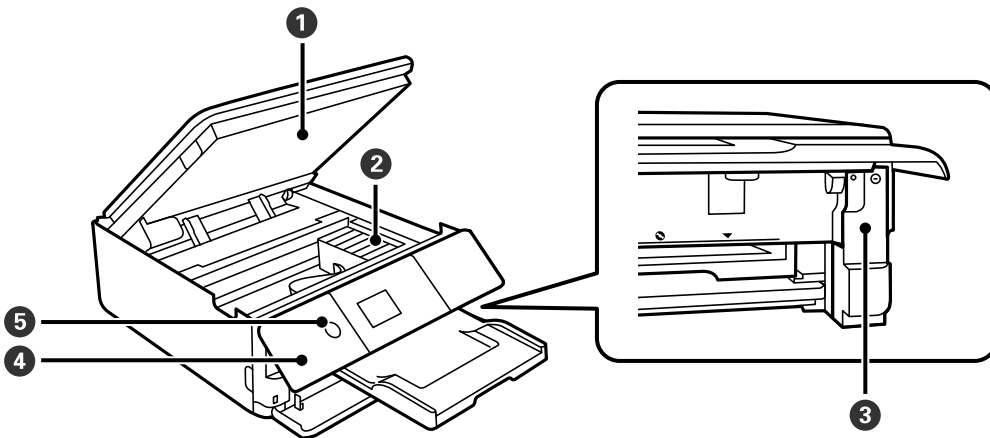

<p>❶</p>	<p>Scanner unit</p>	<p>Scans placed originals. Open to replace the ink cartridges or to remove jammed paper. This unit should usually be kept closed.</p>
<p>❷</p>	<p>Ink cartridge holder</p>	<p>Install the ink cartridges. Ink is ejected from the print head nozzles underneath.</p>
<p>❸</p>	<p>Maintenance box cover</p>	<p>Remove when replacing the maintenance box. The maintenance box is a container that collects a very small amount of surplus ink during cleaning or printing.</p>

### Printer Basics

4	Control panel	Indicates the printer's status and allows you to make print settings. You can change the angle of the control panel.
5	⏻ (Power button/light)	Turns the printer on or off. Unplug the power cord after checking that the power light is off.

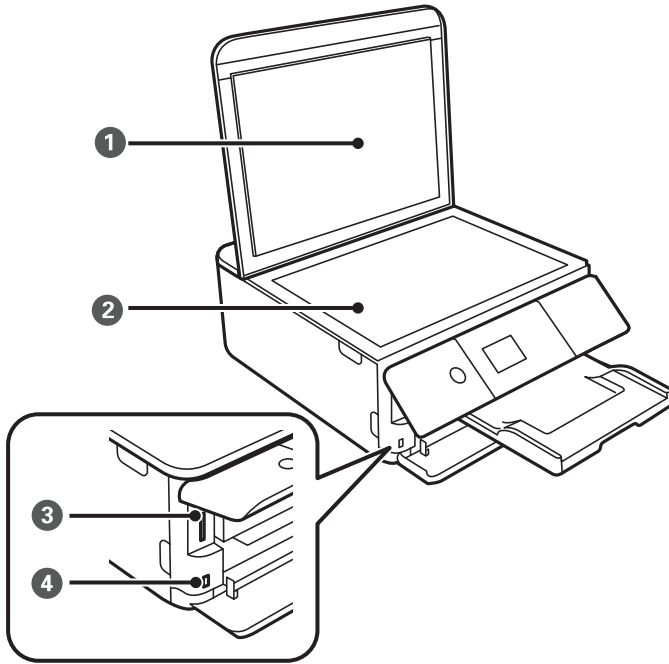

1	Document cover	Blocks external light while scanning.
2	Scanner glass	Place the originals.
3	SD card slot	Insert a memory card.
4	External interface USB port	Connects an external storage device or a PictBridge capable device.

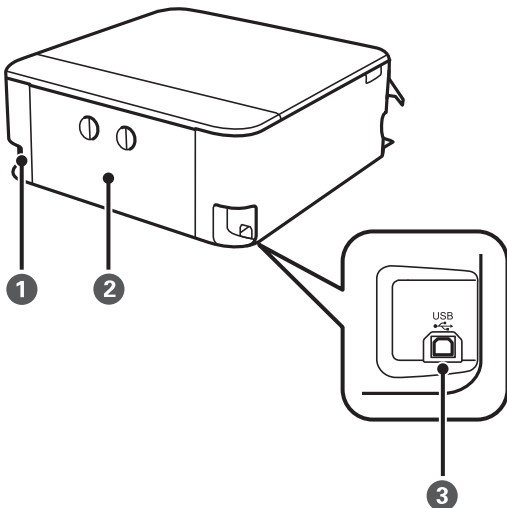

## Printer Basics

①	AC inlet	Connects the power cord.
②	Rear cover	Remove when removing jammed paper.
③	USB port	Connects a USB cable to connect with a computer.

## Control Panel

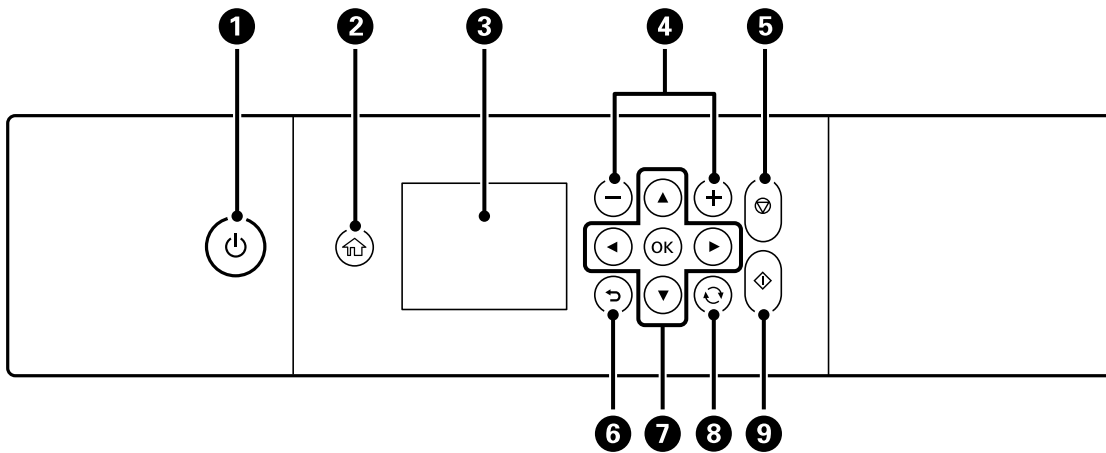

①	Turns the printer on or off. Unplug the power cord after checking that the power light is off.
②	Displays the home screen.
③	Displays menus and messages. Use buttons on the control panel to select or to make settings.
④	Selects the number of pages to print.
⑤	Stops the current operation.
⑥	Returns to the previous screen.
⑦	Use the ▲▼◀▶ buttons to move the focus to the target, and then press the OK button to open the selected menu or to make settings.
⑧	Applies to a variety of functions depending on the situation.
⑨	Starts an operation such as printing or copying.

## Icons displayed in the LCD Screen



The following icons are displayed on the LCD screen depending on the printer's status.

## Printer Basics









### Icons displayed on the home screen

	<p>Displays the <b>Supply Status</b> screen.</p> <div data-bbox="657 376 1139 734" style="border: 1px solid black; padding: 5px; margin: 10px auto; width: fit-content;"> <div style="display: flex; justify-content: space-between; align-items: center;"> <span>Close</span> <span>Supply Status</span> </div> <div style="margin-top: 5px;"> <p>Ink Level</p> <div style="display: flex; justify-content: space-around; margin-bottom: 5px;"> <div style="border: 1px solid gray; width: 40px; height: 20px; margin: 2px;"></div> <div style="border: 1px solid gray; width: 40px; height: 20px; margin: 2px;"></div> <div style="border: 1px solid gray; width: 40px; height: 20px; margin: 2px;"></div> </div> <div style="display: flex; justify-content: space-around; margin-bottom: 5px;"> <span>C</span> <span>BK</span> <span>Y</span> </div> <div style="display: flex; justify-content: space-around; margin-bottom: 5px;"> <div style="border: 1px solid gray; width: 40px; height: 20px; margin: 2px;"></div> <div style="border: 1px solid gray; width: 40px; height: 20px; margin: 2px;"></div> </div> <div style="display: flex; justify-content: space-around; margin-bottom: 5px;"> <span>M</span> <span>PB</span> </div> <p>Remaining capacity of Maintenance box</p> <div style="border: 1px solid gray; width: 100px; height: 15px; margin: 2px;"></div> </div> <div style="display: flex; justify-content: space-between; margin-top: 5px;"> <div style="border: 1px solid black; padding: 2px; width: 40%; text-align: center;">Replace Ink Cartridge(s)</div> <div style="border: 1px solid orange; padding: 2px; width: 40%; text-align: center; color: white;">Print Supply Status Sheet</div> </div> </div>
---	--

## Printer Basics

	<p>Indicates that <b>Quiet Mode</b> is set for the printer. When this feature is enabled, the noise made by printer operations is reduced, but print speed may slow down. However, noises may not be reduced depending on the selected paper type and print quality.</p> <p>Select to change the setting. This is the shortcut for the following menu.</p> <p><b>Settings &gt; Printer Settings &gt; Quiet Mode</b></p>
	<p>Displays the <b>Help</b> screen. You can view the operating instructions or the solutions to problems.</p>

### Icons common to each screen

   	<p>Scrolls the screen from side to side and up and down.</p>
	<p>Cancels the settings and closes the screen.</p>
	<p>Displays additional information.</p>
	<p>Indicates a problem with the items. Select the icon to check how to solve the problem.</p> <p>When this is displayed on  on the home screen, it means the approximate ink levels and the approximate service life of the maintenance box are nearing the end of its service life.</p>

### Related Information

➔ [“Menu Options for Network Settings” on page 182](#)

**Printer Basics**

**Basic Screen Configuration**

The following shows the screen configuration for copying and scanning.

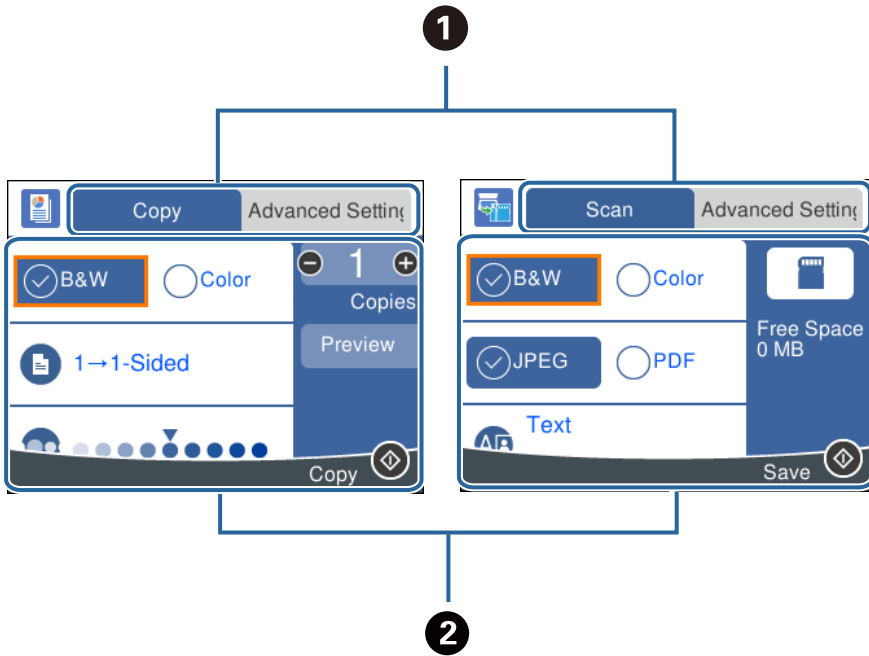

<p>❶</p>	<p>Switches the list of settings using the tabs. The tab on the left displays frequently used items for copying or scanning. The <b>Advanced Settings</b> tab displays other items that you can set as necessary.</p>
<p>❷</p>	<p>Displays the list of setting items. Make settings by selecting the item or adding a check mark. Grayed out items are not available. Select the item to check why it is unavailable.</p>

## Entering Characters

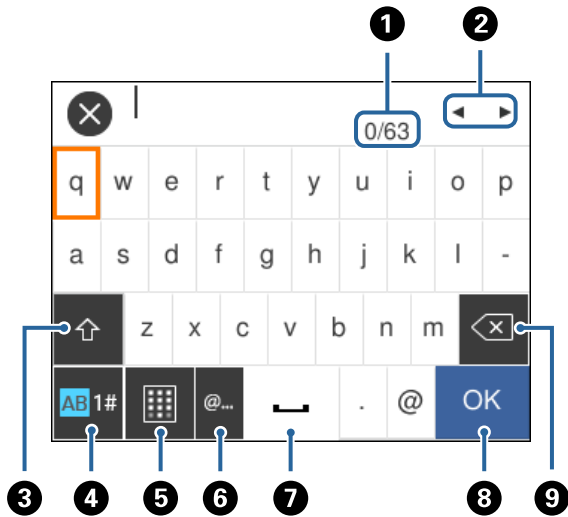

### On-screen Keyboard

You can enter characters and symbols by using on-screen keyboard when you make network settings and so on.



**Note:**

Available icons vary depending on the setting item.

1	Indicates the character count.
2	Moves the cursor to the input position.
3	Switches between upper case and lower case or numbers and symbols. You can also switch them by using the  button.
4	Switches the character type. You can enter alphanumerics, symbols, and special characters such as umlauts and accents. You can also switch them by using the  button.
5	Changes the keyboard layout.
6	Enters frequently used email domain addresses or URLs by simply selecting the item.
7	Enters a space.
8	Enters character.
9	Deletes a character to the left.

### On-screen Keypad

You can enter numbers by using the on-screen keypad when entering the number of copies and so on.

## Printer Basics

The on-screen keypad makes it easier to enter larger numbers. When entering a smaller number, use +/- buttons.

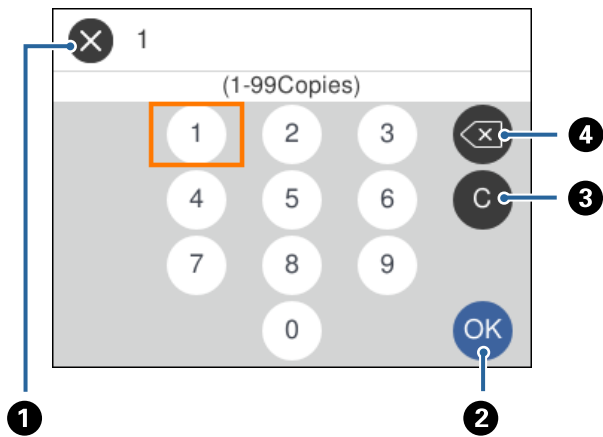

❶	Cancels entering and closes the on-screen keypad.
❷	Confirms the entered numbers and closes the on-screen keypad.
❸	Clears the entered number.
❹	Deletes the entered number to the left.

## Viewing Animations

You can view animations of operating instructions such as loading paper or removing jammed paper on the LCD screen.

- ❑ Select **?** on the home screen: Displays the help screen. Select **How To** and then select the items that you want to view.
- ❑ Select **How To** at the bottom of the operation screen: Displays the context-sensitive animation.

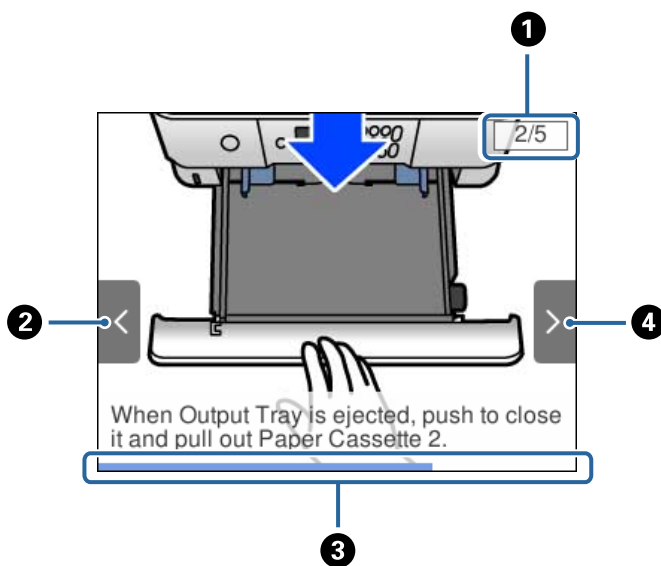



## Printer Basics

<b>1</b>	Indicates the total number of steps and the current step number. In the example above, it shows step 2 from 5 steps.
<b>2</b>	Press ◀ button to return to the previous step.
<b>3</b>	Indicates your progress through the current step. The animation repeats when the progress bar reaches the end.
<b>4</b>	Press ▶ button to move to the next step.

## Displaying a Menu Appropriate to the Operation

The printer automatically displays menus appropriate to your operation. If you want to stop the feature, disable the **Auto Selection Mode** setting.

### Settings > Guide Functions > Auto Selection Mode

- Insert an external memory device such as a memory card or a USB device.

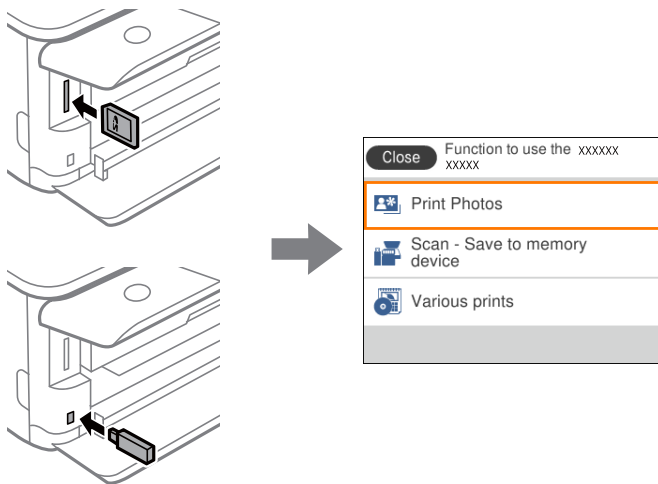

### Related Information

- ➔ [“Menu Options for Guide Functions” on page 184](#)

# Network Settings

---

## Network Connection Types

You can use the following connection methods.

### Wi-Fi Connection

Connect the printer and the computer or smart device to the wireless router. This is the typical connection method for home or office networks where computers are connected by Wi-Fi through the wireless router.

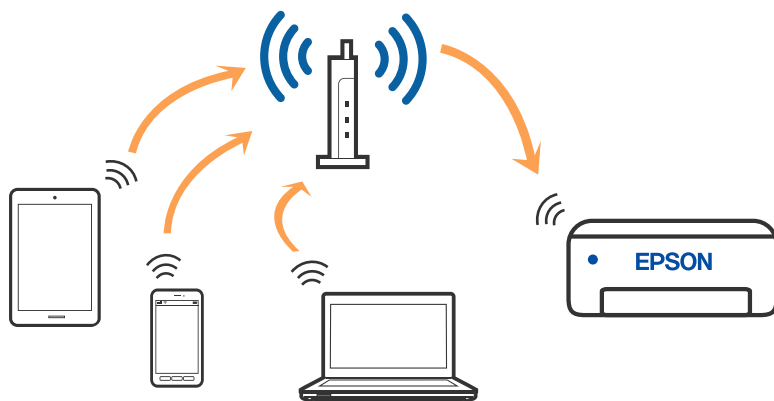

#### Related Information

- ➔ [“Connecting to a Computer” on page 27](#)
- ➔ [“Connecting to a Smart Device” on page 28](#)
- ➔ [“Making Wi-Fi Settings from the Printer” on page 37](#)

### Wi-Fi Direct (Simple AP) Connection

Use this connection method when you are not using Wi-Fi at home or at the office, or when you want to connect the printer and the computer or smart device directly. In this mode, the printer acts as an wireless router and you

## Network Settings

can connect the devices to the printer without having to use a standard wireless router. However, devices directly connected to the printer cannot communicate with each other through the printer.

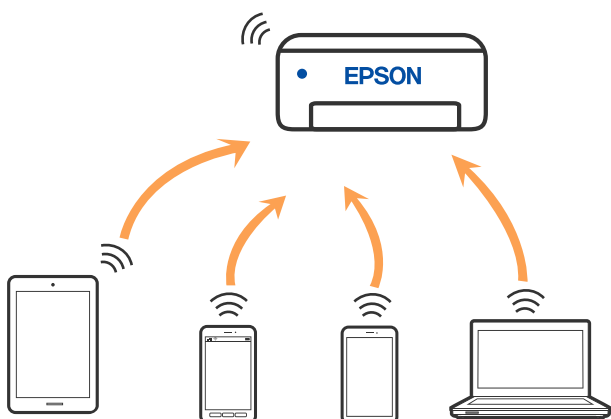

The printer can be connected by Wi-Fi and Wi-Fi Direct (Simple AP) connection simultaneously. However, if you start a network connection in Wi-Fi Direct (Simple AP) connection when the printer is connected by Wi-Fi, the Wi-Fi is temporarily disconnected.

### Related Information

➔ [“Making Wi-Fi Direct \(Simple AP\) Connection Settings” on page 42](#)

---

## Connecting to a Computer

We recommend using the installer to connect the printer to a computer. You can run the installer using one of the following methods.

Setting up from the website

Access the following website, and then enter the product name. Go to **Setup**, and then start setting up.

<http://epson.sn>

Setting up using the software disc (only for the models that come with a software disc and users with Windows computers with disc drives.)

Insert the software disc into the computer, and then follow the on-screen instructions.

### Selecting the Connection Methods

Follow the on-screen instructions until the following screen is displayed, and then select the connection method of the printer to the computer.

## Network Settings

Select the connection type and then click **Next**.

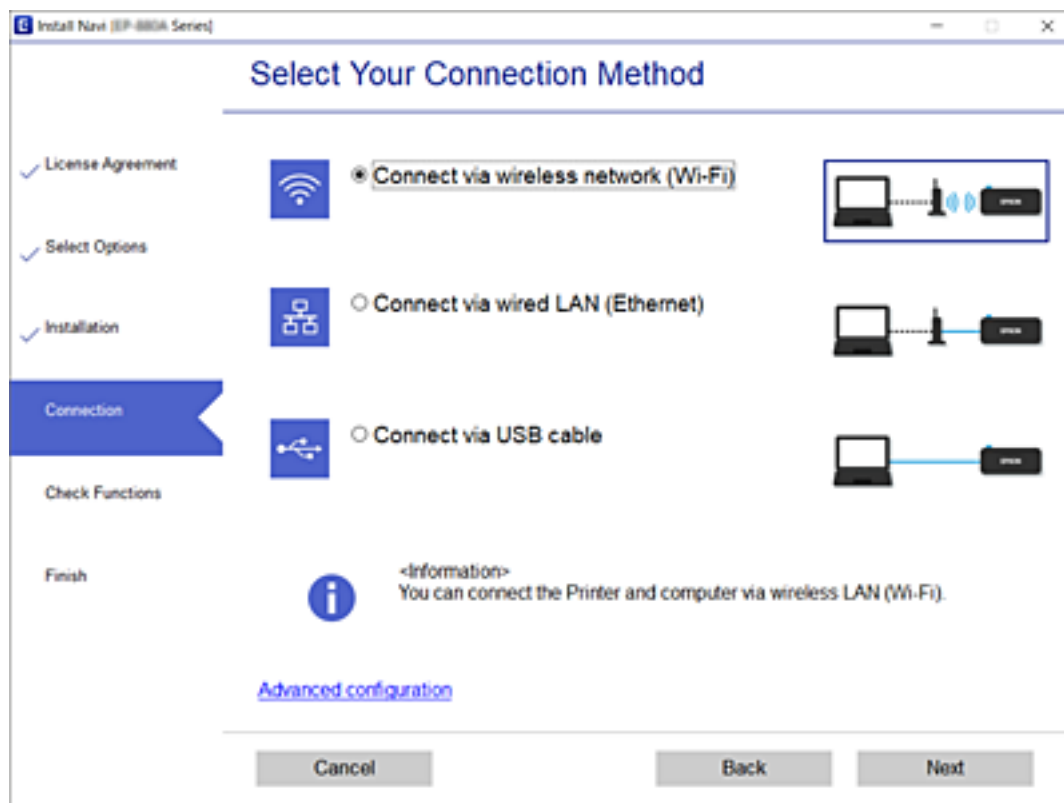

Follow the on-screen instructions.

## Connecting to a Smart Device

### Connecting to a smart device over a wireless router

You can use the printer from a smart device when you connect the printer to the same Wi-Fi network (SSID) as the smart device. To use the printer from a smart device, set up from the following website. Access to the website from the smart device that you want to connect to the printer.

<http://epson.sn> > Setup

**Note:**

*If you want to connect a computer and a smart device to the printer at the same time, we recommend connecting the computer first.*

### Connecting to an iPhone or iPad (iOS devices) using Wi-Fi Direct

This method allows you to connect the printer directly to an iPhone or iPad without a wireless router. The following conditions are required to use this function. If your environment does not match these conditions, you can connect by selecting **Other OS Devices**. See the related information link below for details on connecting.

- iOS 11 or later
- Using the standard camera application to scan the QR code

## Network Settings

- ❑ Epson iPrint version 7.0 or later

Epson iPrint is used to print from a smart device. Install Epson iPrint on the smart device in advance.

**Note:**

*You only need to make these settings for the printer and the smart device that you want to connect to once. Unless you disable Wi-Fi Direct or restore the network settings to their defaults, you do not need to make these settings again.*

1. Select **Smartphone connect** on the home screen.

To select an item, move the focus to the item using the ▲▼◀▶ buttons, and then press the OK button.

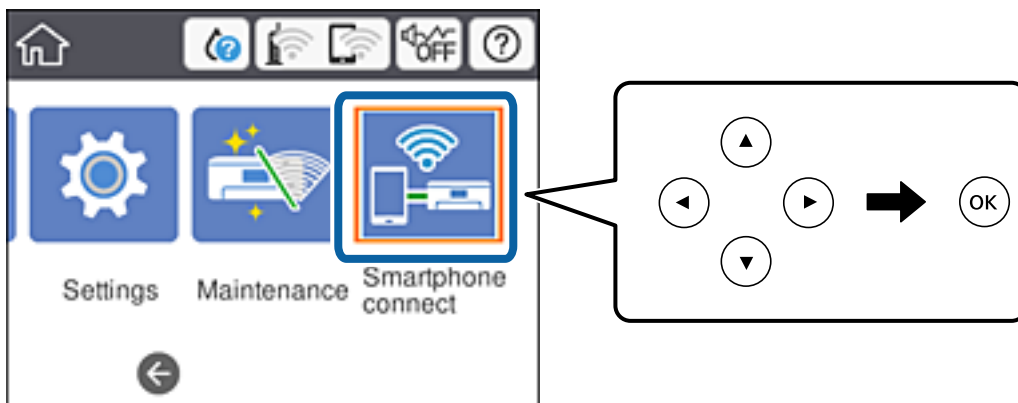

2. Select **Start Setup**.
3. Select **iOS**.

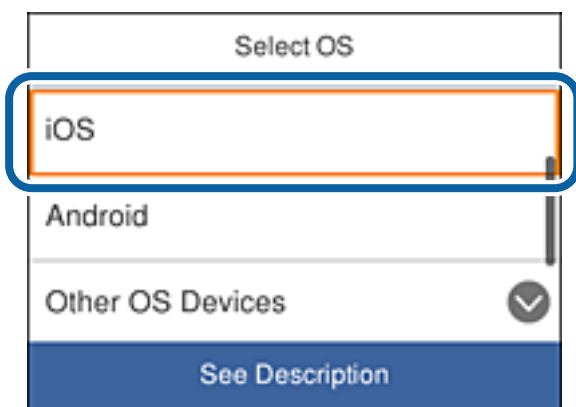

## Network Settings

The QR code is displayed on the printer's control panel.



4. On your iPhone or iPad, start the standard Camera app, and then scan the QR code displayed on the printer's control panel.



Use the Camera app for iOS 11 or later. You cannot connect to the printer using the Camera app for iOS 10 or earlier. Also, you cannot connect using an app for scanning QR codes. If you cannot connect, scroll the screen on the printer's control panel, and then select **Other OS Devices**. See the related information link below for details on connecting.

5. Tap the message displayed on the smart device's screen.

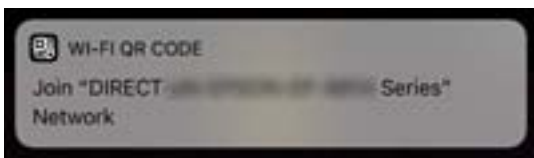

## Network Settings

6. Tap **Join**.

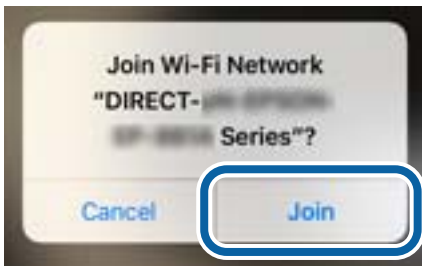

7. On the printer's control panel, select **Next**.
8. On the iPhone or iPad, start Epson iPrint.



9. On the Epson iPrint screen, tap **Printer is not selected..**
10. Select the printer that you want to connect to.



## Network Settings

See the information displayed on the printer's control panel to select the printer.

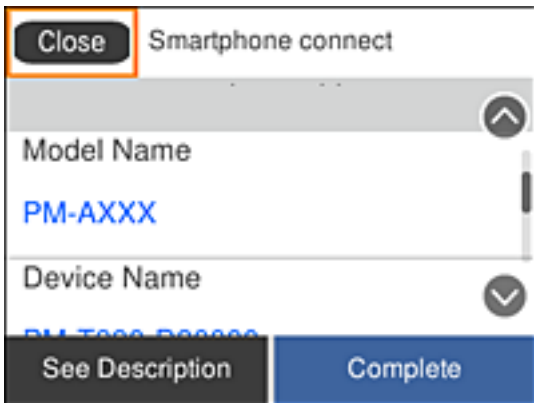

11. On the printer's control panel, select **Complete**.

For smart devices that have been connected to the printer before, select the network name (SSID) on the smart device's Wi-Fi screen to connect them again.

### Related Information

➔ [“Connecting to Devices other than iOS and Android Using Wi-Fi Direct” on page 34](#)

## Connecting to Android Devices Using Wi-Fi Direct

This method allows you to connect the printer directly to your Android device without a wireless router. The following conditions are required to use this function.

- Android 4.4 or later
- Epson iPrint version 7.0 or later

Epson iPrint is used to print from a smart device. Install Epson iPrint on the smart device in advance.

### Note:

*You only need to make these settings for the printer and the smart device that you want to connect to once. Unless you disable Wi-Fi Direct or restore the network settings to their defaults, you do not need to make these settings again.*

1. Select **Smartphone connect** on the home screen.

To select an item, move the focus to the item using the ▲ ▼ ◀ ▶ buttons, and then press the OK button.

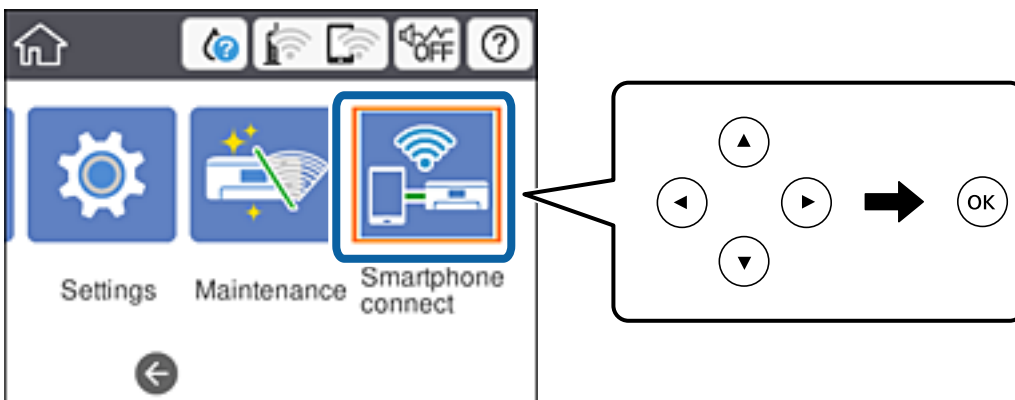



## Network Settings

2. Select **Start Setup**.
3. Select **Android**.

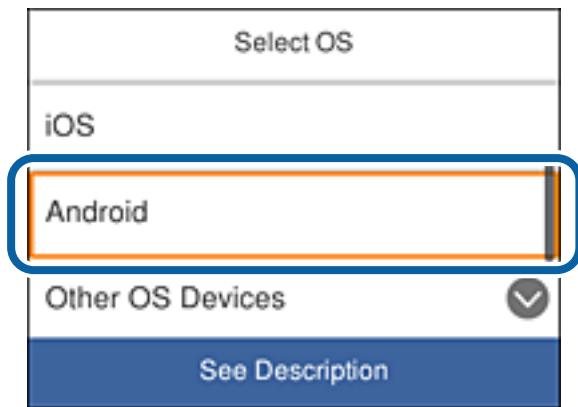

4. On the smart device, start Epson iPrint.



5. On the Epson iPrint screen, tap **Printer is not selected..**
6. On the Epson iPrint screen, select the printer that you want to connect to.



## Network Settings

See the information displayed on the printer's control panel to select the printer.

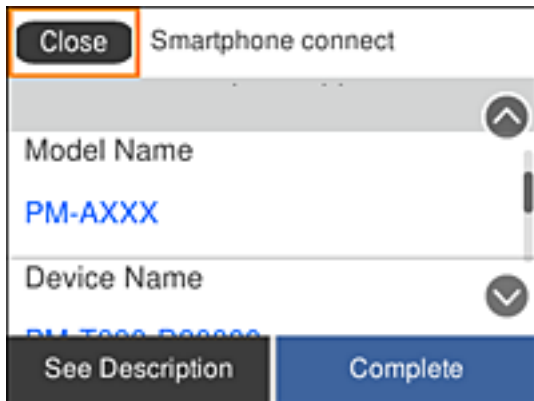

**Note:**

Printers may not be displayed depending on the Android device. If printers are not displayed, connect by selecting **Other OS Devices**. See the related information link below for connecting.

7. When the device connection approval screen is displayed, select **Approve**.
8. On the printer's control panel, select **Complete**.

For smart devices that have been connected to the printer before, select the network name (SSID) on the smart device's Wi-Fi screen to connect them again.

### Related Information

➔ [“Connecting to Devices other than iOS and Android Using Wi-Fi Direct” on page 34](#)

## Connecting to Devices other than iOS and Android Using Wi-Fi Direct

This method allows you to connect the printer directly to smart devices without a wireless router.

**Note:**

You only need to make these settings for the printer and the smart device that you want to connect to once. Unless you disable Wi-Fi Direct or restore the network settings to their defaults, you do not need to make these settings again.

## Network Settings

1. Select **Smartphone connect** on the home screen.

To select an item, move the focus to the item using the ▲▼◀▶ buttons, and then press the OK button.

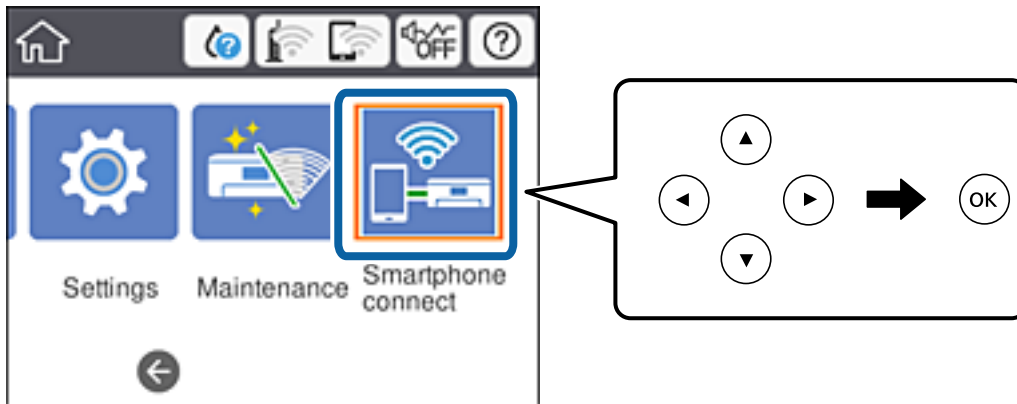

2. Select **Start Setup**.
3. Select **Other OS Devices**.

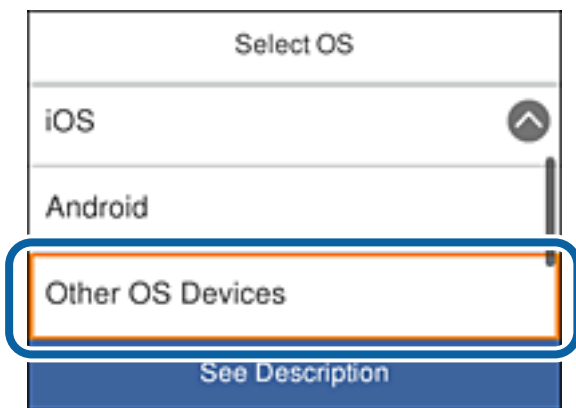

The Network Name(SSID) and Password for Wi-Fi Direct for the printer are displayed.

### Network Settings

4. On the smart device's Wi-Fi screen, select the SSID shown on the printer's control panel, and then enter the password.

The screenshot is an example on iPhone.



5. On the printer's control panel, select **Next**.

## Network Settings

- On the smart device, start Epson iPrint.



- On the Epson iPrint screen, tap **Printer is not selected.**
- Select the printer that you want to connect to.

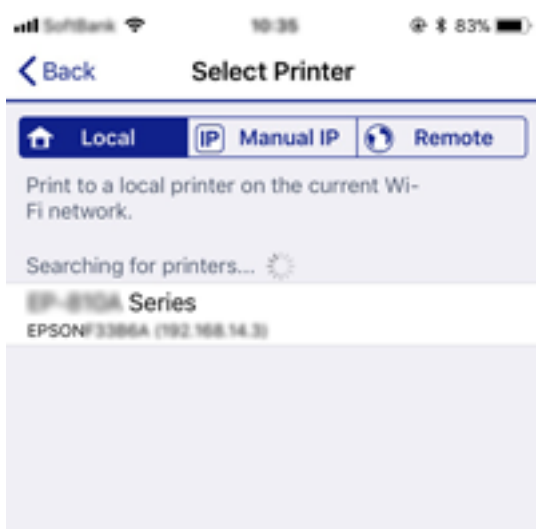

See the information displayed on the printer's control panel to select the printer.

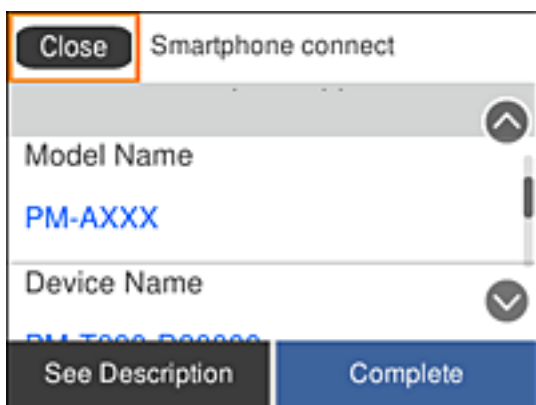

- On the printer's control panel, select **Complete**.

For smart devices that have been connected to the printer before, select the network name (SSID) on the smart device's Wi-Fi screen to connect them again.

---

## Making Wi-Fi Settings from the Printer

You can make network settings from the printer's control panel in several ways. Choose the connection method that matches the environment and conditions that you are using.

## Network Settings

If you know the information for the wireless router such as SSID and password, you can make settings manually.

If the wireless router supports WPS, you can make settings by using push button setup.

After connecting the printer to the network, connect to the printer from the device that you want to use (computer, smart device, tablet, and so on.)

Make advanced network settings to use a static IP address.

### Related Information

- ➔ “Making Wi-Fi Settings by Entering the SSID and Password” on page 38
- ➔ “Making Wi-Fi Settings by Push Button Setup (WPS)” on page 39
- ➔ “Making Wi-Fi Settings by PIN Code Setup (WPS)” on page 41
- ➔ “Making Wi-Fi Direct (Simple AP) Connection Settings” on page 42
- ➔ “Making Advanced Network Settings” on page 43

## Making Wi-Fi Settings by Entering the SSID and Password

You can set up a Wi-Fi network by entering the information necessary to connect to a wireless router from the printer's control panel. To set up using this method, you need the SSID and password for a wireless router.

### Note:

*If you are using a wireless router with its default settings, the SSID and password are on the label. If you do not know the SSID and password, see the documentation provided with the wireless router.*

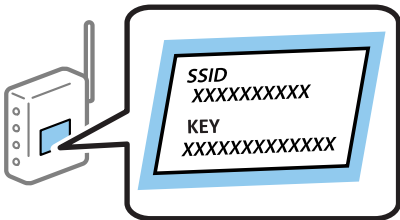

1. Select  |  on the home screen.

To select an item, move the focus to the item using the ▲▼◀▶ buttons, and then press the OK button.

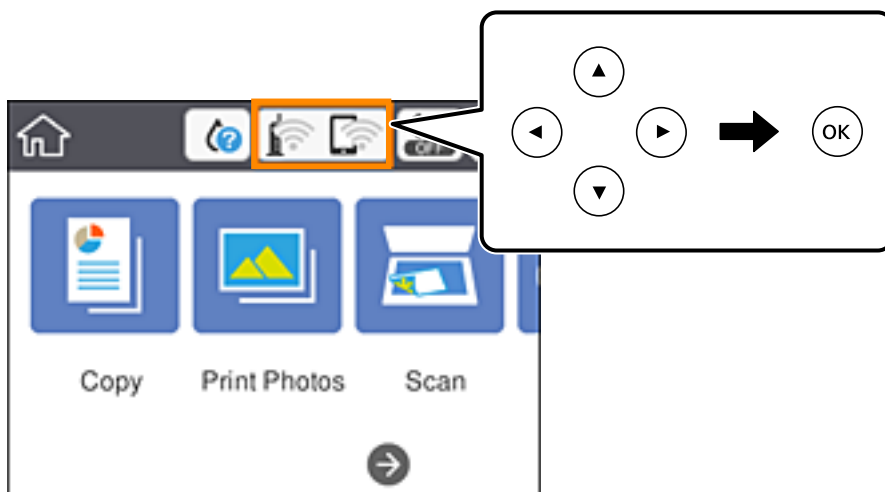

## Network Settings

2. Select **Wi-Fi (Recommended)**.

3. Press the OK button.

If the network connection is already set up, the connection details are displayed. Select **Change Settings** to change the settings.

4. Select **Wi-Fi Setup Wizard**.

5. Select the SSID for the wireless router.

**Note:**

- If the SSID you want to connect to is not displayed on the printer's control panel, press the  button to update the list. If it is still not displayed, press the **+** button, and then enter the SSID directly.
- If you do not know the network name (SSID) check if the information is written on the label of the wireless router. If you are using the wireless router with its default settings, use the SSID on the label. If you cannot find any information, see the documentation provided with the wireless router.

6. Press the OK button, and then enter the password.

**Note:**

- The password is case-sensitive.
- If you do not know the password, check if the information is written on the label of the wireless router. On the label, the password may be written "Network Key", "Wireless Password", and so on. If you are using the wireless router with its default settings, use the password written on the label.

7. When you have finished, select **OK**.

8. Check the settings, and then select **Start Setup**.

9. Select **Dismiss** to finish.

**Note:**

If you fail to connect, load A4 size plain paper, and then select **Print Check Report** to print a connection report.

10. Press the  button.

### Related Information

- ➔ ["Entering Characters" on page 23](#)
- ➔ ["Checking the Network Connection Status" on page 44](#)
- ➔ ["When You Cannot Make Network Settings" on page 216](#)

## Making Wi-Fi Settings by Push Button Setup (WPS)

You can automatically set up a Wi-Fi network by pressing a button on the wireless router. If the following conditions are met, you can set up by using this method.

- The wireless router is compatible with WPS (Wi-Fi Protected Setup).
- The current Wi-Fi connection was established by pressing a button on the wireless router.

**Note:**

If you cannot find the button or you are setting up using the software, see the documentation provided with the wireless router.

## Network Settings

1. Select  |  on the home screen.

To select an item, move the focus to the item using the ▲▼◀▶ buttons, and then press the OK button.

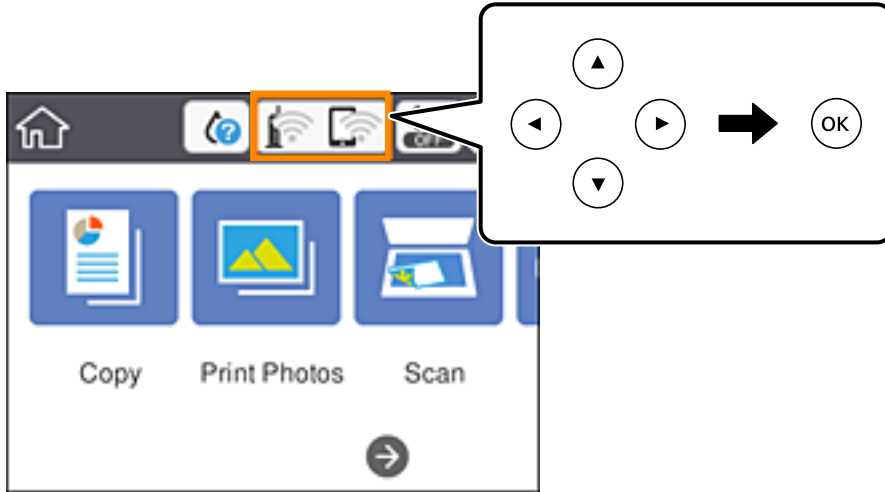

2. Select **Wi-Fi (Recommended)**.

3. Press the OK button.

If the network connection is already set up, the connection details are displayed. Select **Change Settings** to change the settings.

4. Select **Push Button Setup (WPS)**.

5. Hold down the [WPS] button on the wireless router until the security light flashes.

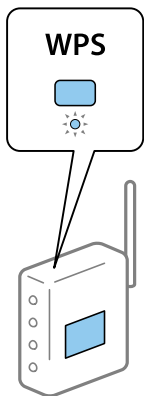

If you do not know where the [WPS] button is, or there are no buttons on the wireless router, see the documentation provided with your wireless router for details.

6. Press the OK button on the printer.

7. Close the screen.

The screen automatically closes after a specific length of time.

**Note:**

*If connection fails, restart the wireless router, move it closer to the printer, and try again. If it still does not work, print a network connection report and check the solution.*



## Network Settings

- Press the  button.





### Related Information

- ➔ [“Checking the Network Connection Status” on page 44](#)
- ➔ [“When You Cannot Make Network Settings” on page 216](#)

## Making Wi-Fi Settings by PIN Code Setup (WPS)

You can automatically connect to a wireless router by using a PIN code. You can use this method to set up if a wireless router is capable of WPS (Wi-Fi Protected Setup). Use a computer to enter a PIN code into the wireless router.

- Select  |  on the home screen.

To select an item, move the focus to the item using the     buttons, and then press the OK button.

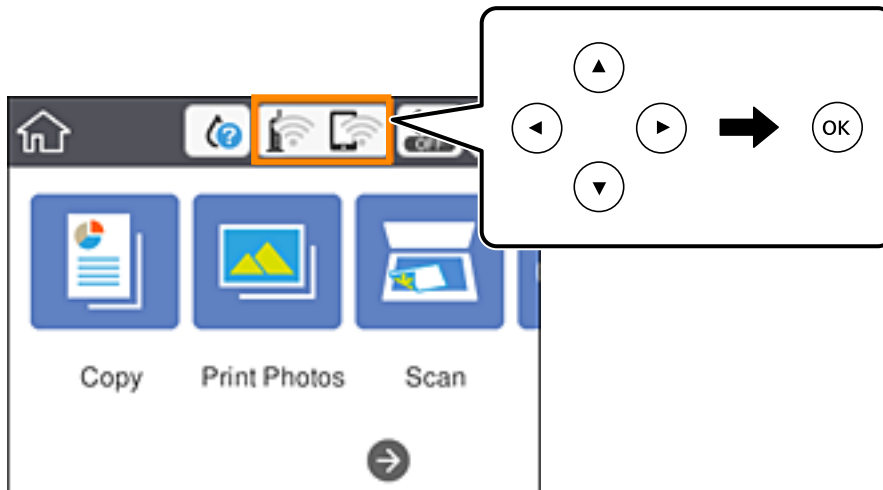

- Select **Wi-Fi (Recommended)**.

- Press the OK button.

If the network connection is already set up, the connection details are displayed. Select **Change Settings** to change the settings.

- Select **Others > PIN Code Setup (WPS)**.

- Use your computer to enter the PIN code (an eight digit number) displayed on the printer's control panel into the wireless router within two minutes.

**Note:**

See the documentation provided with your wireless router for details on entering a PIN code.

- Press the OK button on the printer.

- Close the screen.

The screen automatically closes after a specific length of time.

## Network Settings

**Note:**

If connection fails, restart the wireless router, move it closer to the printer, and try again. If it still does not work, print a connection report and check the solution.

- Press the  button.





### Related Information

- ➔ [“Checking the Network Connection Status” on page 44](#)
- ➔ [“When You Cannot Make Network Settings” on page 216](#)

## Making Wi-Fi Direct (Simple AP) Connection Settings

This method allows you to connect the printer directly to devices without a wireless router. The printer acts as a wireless router.

- Select  |  on the home screen.

To select an item, move the focus to the item using the     buttons, and then press the OK button.

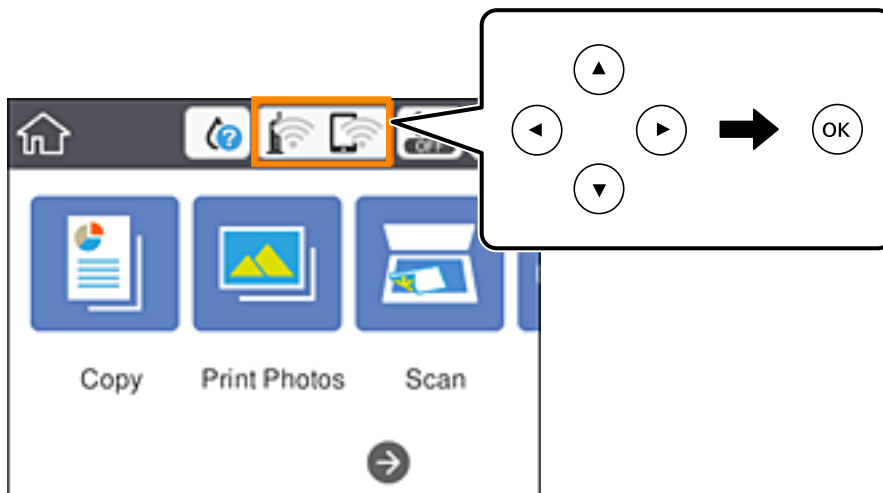

- Select **Wi-Fi Direct**.
- Press the OK button.

If you have made Wi-Fi Direct (Simple AP) settings, the detailed connection information is displayed. Go to step 5.

- Press the OK button to start making settings.
- Check the SSID and password displayed on the printer's control panel.

On the computer's network connection screen or the smart device's Wi-Fi screen, select the SSID shown on the printer's control panel to connect.

## Network Settings

6. Enter the password displayed on the printer's control panel on the computer or smart device.

**Note:**

When you enable Wi-Fi Direct, it remains enabled unless you restore the default network settings and disable Wi-Fi Direct.

7. After the connection is established, select **Dismiss** on the printer's control panel.
8. Press the  button.





### Related Information

- ➔ [“Checking the Network Connection Status” on page 44](#)
- ➔ [“When You Cannot Make Network Settings” on page 216](#)

## Making Advanced Network Settings

You can change the network device name, TCP/IP setup, proxy server and so on. Check your network environment before making changes.

1. Select **Settings** on the home screen.

To select an item, move the focus to the item using the     buttons, and then press the OK button.

2. Select **Network Settings > Advanced**.
3. Select the menu item for settings, and then select or specify the setting values.
4. Select **Start Setup**.

### Related Information

- ➔ [“Setting Items for Advanced Network Settings” on page 43](#)

## Setting Items for Advanced Network Settings

Select the menu item for settings, and then select or specify the setting values.

- Device Name

You can enter the following characters.

- Character limits: 2 to 15 (you must enter at least 2 characters)
- Usable characters: A to Z, a to z, 0 to 9, -.
- Characters you cannot use at the top: 0 to 9, -.
- Characters you cannot use at the bottom: -

## Network Settings

### TCP/IP

#### Auto

Select when you are using an access point at home or you are allowing the IP address to be acquired automatically by DHCP.

#### Manual

Select when you do not want the printer's IP address to be changed. Enter the addresses for IP Address, Subnet Mask, and Default Gateway, and make DNS Server settings according to your network environment.

When you select **Auto** for the IP address assignment settings, you can select the DNS server settings from **Manual** or **Auto**. If you cannot obtain the DNS server address automatically, select **Manual**, and then enter the primary DNS server and secondary DNS server address directly.

### Proxy Server

#### Do Not Use

Select when you are using the printer in a home network environment.

#### Use

Select when you are using a proxy server in your network environment and you want to set it to the printer. Enter the proxy server address and port number.

---

## Checking the Network Connection Status

You can check the network connection status in the following way.

### Network Icon

You can check the network connection status and strength of the radio wave using the network icon on the printer's home screen.



#### Related Information

➔ [“Icons displayed in the LCD Screen” on page 19](#)

## Checking Detailed Network Information from the Control Panel

When your printer is connected to the network, you can also view other network-related information by selecting the network menus you want to check.

## Network Settings

1. Select **Settings** on the home screen.

To select an item, move the focus to the item using the ▲ ▼ ◀ ▶ buttons, and then press the OK button.

2. Select **Network Settings > Network Status**.

3. To check the information, select the menus that you want to check.

- Wi-Fi Status

Displays the network information (device name, connection, signal strength, obtain IP address, and so on) for Wi-Fi connections.

- Wi-Fi Direct Status

Displays whether Wi-Fi Direct (Simple AP) is enabled or disabled for Wi-Fi Direct (Simple AP) connections.

- Print Status Sheet

Prints a network status sheet. The information for Wi-Fi, Wi-Fi Direct (Simple AP), and so on is printed on two or more pages.

## Printing a Network Connection Report

You can print a network connection report to check the status between the printer and the wireless router.

1. Load papers.

2. Select **Settings** on the home screen.

To select an item, move the focus to the item using the ▲ ▼ ◀ ▶ buttons, and then press the OK button.

3. Select **Network Settings > Connection Check**.

The connection check starts.

4. Select **Print Check Report**.

5. Follow the instructions on the printer's screen to print the network connection report.

If an error has occurred, check the network connection report, and then follow the printed solutions.

6. Press the OK button.

### Related Information

➔ [“Messages and Solutions on the Network Connection Report” on page 46](#)

## Network Settings

### Messages and Solutions on the Network Connection Report

Check the messages and error codes on the network connection report, and then follow the solutions.

Check Network Connection	
Check Result	FAIL
Error code	(E-2)
<p>See the Network Status and check if the Network Name (SSID) is the SSID you want to connect. If the SSID is correct, make sure to enter the correct password and try again.</p> <p>If your problems persist, see your documentation for help and networking tips.</p>	
Checked Items	
Wireless Network Name (SSID) Check	FAIL
Communication Mode Check	Unchecked
Security Mode Check	Unchecked
MAC Address Filtering Check	Unchecked
Security Key/Password Check	Unchecked
IP Address Check	Unchecked
Detailed IP Setup Check	Unchecked
Network Status	
Printer Name	EPSON XXXXXX
Printer Model	XX-XXX Series
IP Address	169.254.137.8
Subnet Mask	255.255.0.0
Default Gateway	
Network Name (SSID)	EpsonNet
Security	None
Signal Strength	Poor
MAC Address	F8:D0:27:40:C0:AC

a. Error code

b. Messages on the Network Environment

#### Related Information

- ➔ “E-1” on page 47
- ➔ “E-2, E-3, E-7” on page 47
- ➔ “E-5” on page 48
- ➔ “E-6” on page 48
- ➔ “E-8” on page 48
- ➔ “E-9” on page 49
- ➔ “E-10” on page 49
- ➔ “E-11” on page 49
- ➔ “E-12” on page 50
- ➔ “E-13” on page 50
- ➔ “Message on the Network Environment” on page 51

## Network Settings

### E-1

#### Solutions:

- Make sure the Ethernet cable is securely connected to your printer and to your hub or other network device.
- Make sure your hub or other network device is turned on.
- If you want to connect the printer by Wi-Fi, make Wi-Fi settings for the printer again because it is disabled.

### E-2, E-3, E-7

#### Solutions:

- Make sure your wireless router is turned on.
- Confirm that your computer or device is connected correctly to the wireless router.
- Turn off the wireless router. Wait for about 10 seconds, and then turn it on.
- Place the printer closer to your wireless router and remove any obstacles between them.
- If you have entered the SSID manually, check if it is correct. Check the SSID from the **Network Status** part on the network connection report.
- If an wireless router has multiple SSIDs, select the SSID that is displayed. When the SSID is using a non-compliant frequency, the printer does not display them.
- If you are using push button setup to establish a network connection, make sure your wireless router supports WPS. You cannot use push button setup if your wireless router does not support WPS.
- Make sure your SSID uses only ASCII characters (alphanumeric characters and symbols). The printer cannot display an SSID that contains non-ASCII characters.
- Make sure you know your SSID and password before connecting to the wireless router. If you are using a wireless router with its default settings, the SSID and password are located on a label on the wireless router. If you do not know your SSID and password, contact the person who set up the wireless router, or see the documentation provided with the wireless router.
- If you are connecting to an SSID generated from a tethering smart device, check for the SSID and password in the documentation provided with the smart device.
- If your Wi-Fi connection suddenly disconnects, check for the conditions below. If any of these conditions are applicable, reset your network settings by downloading and running the software from the following website.  
<http://epson.sn> > **Setup**
  - Another smart device was added to the network using push button setup.
  - The Wi-Fi network was set up using any method other than push button setup.

#### Related Information

- ➔ [“Connecting to a Computer” on page 27](#)
- ➔ [“Making Wi-Fi Settings from the Printer” on page 37](#)

## Network Settings

### E-5

#### Solutions:

Make sure the wireless router's security type is set to one of the following. If it is not, change the security type on the wireless router, and then reset the printer's network settings.

- WEP-64 bit (40 bit)
- WEP-128 bit (104 bit)
- WPA PSK (TKIP/AES)\*
- WPA2 PSK (TKIP/AES)\*
- WPA (TKIP/AES)
- WPA2 (TKIP/AES)

\* WPA PSK is also known as WPA Personal. WPA2 PSK is also known as WPA2 Personal.

### E-6

#### Solutions:

- Check if MAC address filtering is disabled. If it is enabled, register the printer's MAC address so that it is not filtered. See the documentation provided with the wireless router for details. You can check the printer's MAC address from the **Network Status** part on the network connection report.
- If your wireless router is using shared authentication with WEP security, make sure the authentication key and index are correct.
- If the number of connectable devices on the wireless router is less than the number of network devices that you want to connect, make settings on the wireless router to increase the number of connectable devices. See the documentation provided with the wireless router to make settings.

#### Related Information

➔ ["Connecting to a Computer" on page 27](#)

### E-8

#### Solutions:

- Enable DHCP on the wireless router if the printer's Obtain IP Address setting is set to **Auto**.
- If the printer's Obtain IP Address setting is set to Manual, the IP address you manually set is invalid due to out of range (for example: 0.0.0.0). Set a valid IP address from the printer's control panel or by using Web Config.

#### Related Information

➔ ["Making Advanced Network Settings" on page 43](#)



## Network Settings

### E-9

#### Solutions:

Check the following.

- Devices are turned on.
- You can access the Internet and other computers or network devices on the same network from the devices you want to connect to the printer.

If still does not connect your printer and network devices after confirming the above, turn off the wireless router. Wait for about 10 seconds, and then turn it on. Then reset your network settings by downloading and running the installer from the following website.

<http://epson.sn> > Setup

#### Related Information

➔ [“Connecting to a Computer” on page 27](#)

### E-10

#### Solutions:

Check the following.

- Other devices on the network are turned on.
- Network addresses (IP address, subnet mask, and default gateway) are correct if you have set the printer's Obtain IP Address to Manual.

Reset the network address if they are incorrect. You can check the IP address, subnet mask, and default gateway from the **Network Status** part on the network connection report.

If DHCP is enabled, change the printer's Obtain IP Address setting to **Auto**. If you want to set the IP address manually, check the printer's IP address from the **Network Status** part on the network connection report, and then select Manual on the network settings screen. Set the subnet mask to [255.255.255.0].

If still does not connect your printer and network devices, turn off the wireless router. Wait for about 10 seconds, and then turn it on.

#### Related Information

➔ [“Making Advanced Network Settings” on page 43](#)

➔ [“Printing a Network Status Sheet” on page 51](#)

### E-11

#### Solutions:

Check the following.

- The default gateway address is correct if you set the printer's TCP/IP Setup setting to Manual.
- The device that is set as the default gateway is turned on.

## Network Settings

Set the correct default gateway address. You can check the default gateway address from the **Network Status** part on the network connection report.

### Related Information

- ➔ “Making Advanced Network Settings” on page 43
- ➔ “Printing a Network Status Sheet” on page 51

## E-12

### Solutions:

Check the following.

- Other devices on the network are turned on.
- The network addresses (IP address, subnet mask, and default gateway) are correct if you are entering them manually.
- The network addresses for other devices (subnet mask and default gateway) are the same.
- The IP address does not conflict with other devices.

If still does not connect your printer and network devices after confirming the above, try the following.

- Turn off the wireless router. Wait for about 10 seconds, and then turn it on.
- Make network settings again using the installer. You can run it from the following website.  
<http://epson.sn> > **Setup**
- You can register several passwords on a wireless router that uses WEP security type. If several passwords are registered, check if the first registered password is set on the printer.

### Related Information

- ➔ “Making Advanced Network Settings” on page 43
- ➔ “Connecting to a Computer” on page 27

## E-13

### Solutions:

Check the following.

- Network devices such as a wireless router, hub, and router are turned on.
- The TCP/IP Setup for network devices has not been set up manually. (If the printer's TCP/IP Setup is set automatically while the TCP/IP Setup for other network devices is performed manually, the printer's network may differ from the network for other devices.)

If it still does not work after checking the above, try the following.

- Turn off the wireless router. Wait for about 10 seconds, and then turn it on.
- Make network settings on the computer that is on the same network as the printer using the installer. You can run it from the following website.  
<http://epson.sn> > **Setup**

## Network Settings

- You can register several passwords on a wireless router that uses the WEP security type. If several passwords are registered, check if the first registered password is set on the printer.

### Related Information

- ➔ [“Making Advanced Network Settings” on page 43](#)
- ➔ [“Connecting to a Computer” on page 27](#)

## Message on the Network Environment

Message	Solution
*Multiple network names (SSID) that match your entered network name (SSID) have been detected. Confirm network name (SSID).	The same SSID may be set on several wireless router. Check the settings on the wireless router, and change the SSID.
The Wi-Fi environment needs to be improved. Turn the wireless router off and then turn it on. If the connection does not improve, see the documentation for the wireless router.	After moving the printer closer to the wireless router and removing any obstacles between them, turn off the wireless router. Wait for about 10 seconds, and then turn it on. If it still does not connect, see the documentation supplied with the wireless router.
*No more devices can be connected. Disconnect one of the connected devices if you want to add another one.	Computer and smart devices that can be connected simultaneously are connected in full in the Wi-Fi Direct (Simple AP) connection. To add another computer or smart device, disconnect one of the connected devices first.  You can confirm the number of wireless devices which can be connected simultaneously and the number of connected devices by checking the network status sheet or the printer's control panel.
The same SSID as Wi-Fi Direct exists in the environment. Change the Wi-Fi Direct SSID if you cannot connect a smart device to the printer.	On the printer's control panel, go to Wi-Fi Direct Setup screen and select the menu to change the setting. You can change the network name following after DIRECT-XX-. Enter within 32 characters.

## Printing a Network Status Sheet

You can check the detailed network information by printing it.

1. Load papers.
2. Select **Settings**.

To select an item, move the focus to the item using the ▲ ▼ ◀ ▶ buttons, and then press the OK button.

3. Select **Network Settings** > **Network Status**.
4. Select **Print Status Sheet**.
5. Check the message, and then print the network status sheet.
6. Press the OK button.

## Replacing or Adding New Wireless Routers

If the SSID changes due to the replacement of a wireless router, or a wireless router is added and a new network environment is established, re-set the Wi-Fi settings.

### Related Information

➔ “Changing the Connection Method to a Computer” on page 52

---

## Changing the Connection Method to a Computer

Using the installer and re-set up in a different connection method.

### Setting up from the website

Access the following website, and then enter the product name. Go to **Setup**, and then start setting up.

<http://epson.sn>

### Setting up using the software disc (only for the models that come with a software disc and users with Windows computers with disc drives.)

Insert the software disc into the computer, and then follow the on-screen instructions.

### Selecting Change the Connection Methods

Follow the on-screen instructions until the following screen is displayed.

Select **Set up Printer connection again (for new network router or changing USB to network, etc.)** on the Install Software screen, and then click **Next**.

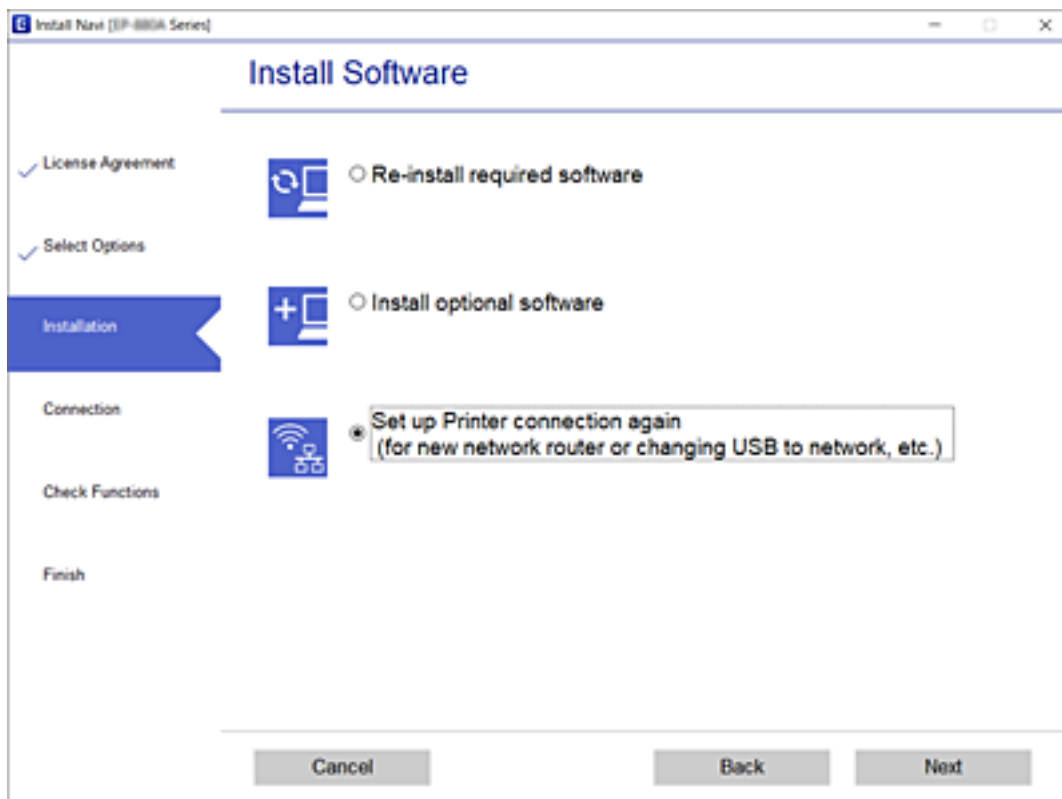

---

## Changing the Wi-Fi Direct (Simple AP) Settings

When Wi-Fi Direct (simple AP) connection is enabled, you can change the settings from  > **Wi-Fi Direct** > **Change Settings**, and then the following menu items are displayed.

To select an item, move the focus to the item using the ▲ ▼ ◀ ▶ buttons, and then press the OK button.

### Change Network Name

Change the Wi-Fi Direct (simple AP) network name (SSID) used for connecting to the printer to your arbitrary name. You can set the network name (SSID) in ASCII characters that is displayed on the software keyboard on the control panel.

When changing the network name (SSID), all connected devices are disconnected. Use the new network name (SSID) if you want to re-connect the device.

### Change Password

Change the Wi-Fi Direct (simple AP) password for connecting to the printer to your arbitrary value. You can set the password in ASCII characters that is displayed on the software keyboard on the control panel.

When changing the password, all connected devices are disconnected. Use the new password if you want to re-connect the device.

### Disable Wi-Fi Direct

Disable Wi-Fi Direct (simple AP) settings of the printer. When disabling it, all devices connected to the printer in Wi-Fi Direct (Simple AP) connection are disconnected.

### Restore Default Settings

Restore all Wi-Fi Direct (simple AP) settings to their defaults.

The Wi-Fi Direct (simple AP) connection information of the smart device saved to the printer is deleted.

---

## Disabling Wi-Fi from the Control Panel

When Wi-Fi is disabled, the Wi-Fi connection is disconnected.

## Network Settings

1. Select  on the home screen.

To select an item, move the focus to the item using the ▲▼◀▶ buttons, and then press the OK button.

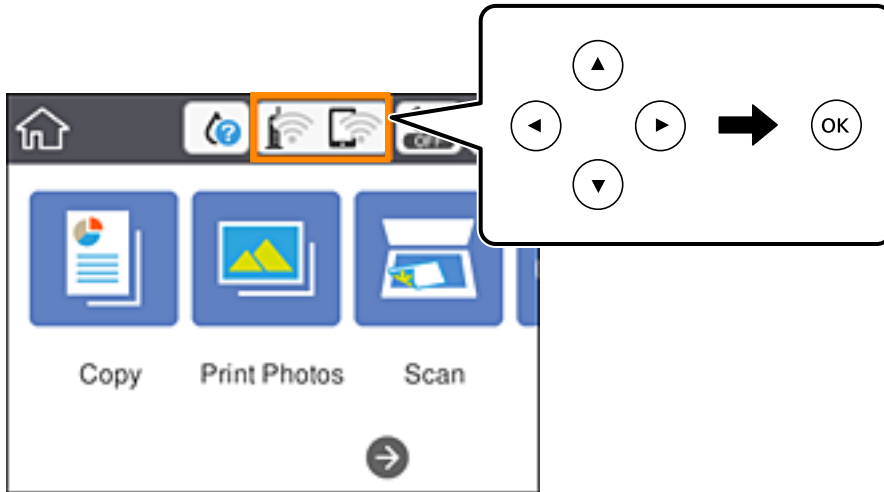

2. Select **Wi-Fi (Recommended)**.  
The network status is displayed.
3. Select **Change Settings**.
4. Select **Others > Disable Wi-Fi**.
5. Check the message, and then start setup.
6. When a completion message is displayed, close the screen.  
The screen automatically closes after a specific length of time.
7. Press the  button.

---

## Disconnecting Wi-Fi Direct (Simple AP) Connection from the Control Panel

**Note:**

When Wi-Fi Direct (Simple AP) connection disabled, all computers and smart devices connected to the printer in Wi-Fi Direct (Simple AP) connection are disconnected. If you want to disconnect a specific device, disconnect from the device instead of the printer.

## Network Settings

1. Select  on the home screen.

To select an item, move the focus to the item using the ▲▼◀▶ buttons, and then press the OK button.

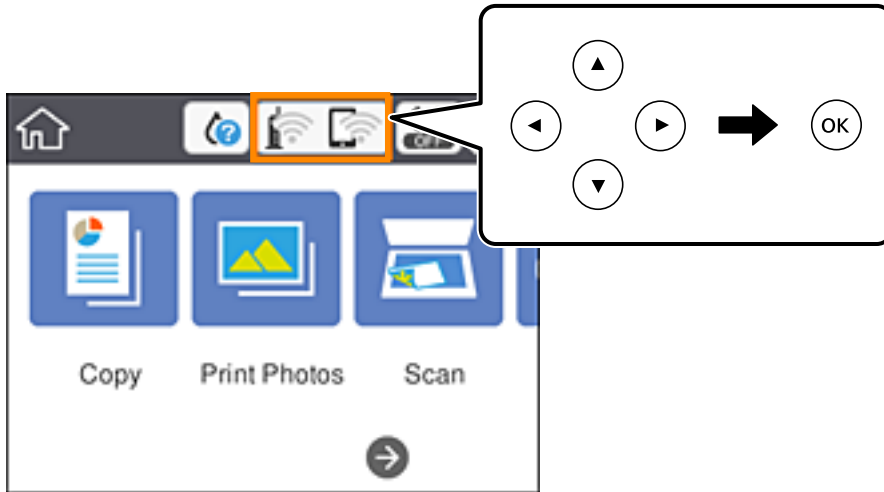

2. Select **Wi-Fi Direct**.  
The Wi-Fi Direct information is displayed.
3. Select **Change Settings**.
4. Select **Disable Wi-Fi Direct**.
5. Press the OK button.
6. When a completion message is displayed, close the screen.  
The screen automatically closes after a specific length of time.
7. Press the  button.

---

## Restoring the Network Settings from the Control Panel

You can restore all network settings to their defaults.

1. Select **Settings** on the home screen.  
To select an item, move the focus to the item using the ▲▼◀▶ buttons, and then press the OK button.
2. Select **Restore Default Settings > Network Settings**.
3. Check the message, and then select **Yes**.
4. When a completion message is displayed, close the screen.  
The screen automatically closes after a specific length of time.

## Network Settings

### Related Information

- ➔ [“Connecting to a Computer” on page 27](#)
- ➔ [“Making Wi-Fi Settings from the Printer” on page 37](#)



# Loading Paper

## Paper Handling Precautions

- ❑ Read the instruction sheets supplied with the paper.
- ❑ Fan and align the edges of the paper before loading. Do not fan or curl photo paper. Doing so may damage the printable side.

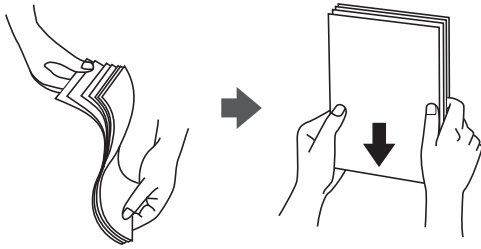

- ❑ If the paper is curled, flatten it or curl it slightly in the opposite direction before loading. Printing on curled paper may cause paper jams and smears on the printout.

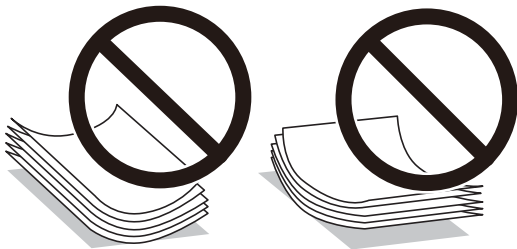

- ❑ Do not use paper that is wavy, torn, cut, folded, damp, too thick, too thin, or paper that has stickers stuck to it. Using these types of paper causes paper jams and smears on the printout.
- ❑ Fan and align the edges of the envelopes before loading. When the stacked envelopes are puffed up with air, press them down to flatten them before loading.

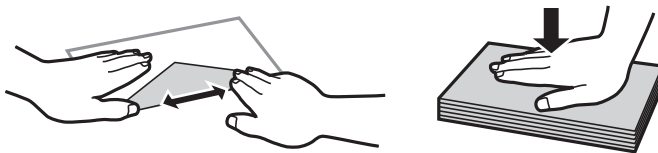

- ❑ Do not use envelopes that are curled or folded. Using these envelopes causes paper jams and smears on the printout.
- ❑ Do not use envelopes with adhesive surfaces on the flaps or window envelopes.
- ❑ Avoid using envelopes that are too thin, as they may curl during printing.

### Related Information

- ➔ [“Printer Specifications” on page 237](#)

## Available Paper and Capacities

### Genuine Epson Paper

Epson recommends using genuine Epson paper to ensure high-quality printouts.

**Note:**

The availability of paper varies by location. For the latest information on paper available in your area, contact Epson support.

#### Paper suitable for printing documents

Media Name	Size	Loading Capacity (Sheets)		2-Sided Printing	Borderless Printing* <sup>1</sup>
		Paper Cassette 1	Paper Cassette 2		
Epson Bright White Ink Jet Paper	A4	–	80* <sup>2</sup>	Auto, Manual	–

\*1 Borderless printing is not available for 2-sided printing.

\*2 For manual 2-sided printing, you can load up to 30 sheets for paper with one side already printed.

#### Paper suitable for printing documents and photos

Media Name	Size	Loading Capacity (Sheets)		2-Sided Printing	Borderless Printing* <sup>1</sup>
		Paper Cassette 1	Paper Cassette 2		
Epson Photo Quality Ink Jet Paper	A4	–	80	–	–
Epson Double-sided Photo Quality Ink Jet Paper	A4	–	50* <sup>2</sup>	Auto, Manual	–
Epson Matte Paper-Heavyweight	A4	–	20	–	✓
Epson Double-Sided Matte Paper	A4	–	1	Manual	✓

\*1 Borderless printing is not available for 2-sided printing.

\*2 For manual 2-sided printing, you can load up to 1 sheet for paper with one side already printed.

## Loading Paper

Paper suitable for printing photos 

Media Name	Size	Loading Capacity (Sheets)		2-Sided Printing	Borderless Printing
		Paper Cassette 1	Paper Cassette 2		
Epson Ultra Glossy Photo Paper	A4	–	20	–	✓
	13x18 cm (5x7 in.), 10x15 cm (4x6 in.)	20	20		
Epson Premium Glossy Photo Paper	A4	–	20	–	✓
	13x18 cm (5x7 in.), 16:9 wide size (102x181 mm), 10x15 cm (4x6 in.)	20	20		
Epson Premium Semigloss Photo Paper	A4	–	20	–	✓
	10x15 cm (4x6 in.)	20	20		
Epson Photo Paper Glossy	A4	–	20	–	✓
	13x18 cm (5x7 in.), 10x15 cm (4x6 in.)	20	20		

Various other paper types 

Media Name	Size	Loading Capacity (Sheets)		 *1	2-Sided Printing	Borderless Printing
		Paper Cassette 1	Paper Cassette 2			
Epson Photo Stickers 16	A6	1	1	–	–	–
Epson Iron-On Cool Peel Transfer Paper*1	A4	–	1	–	–	–

\*1 Only printing from computer is available.

## Related Information

➔ [“Part Names and Functions” on page 16](#)

## Loading Paper

## Commercially Available Paper

## Plain papers

Media Name	Size	Loading Capacity (Sheets)		2-Sided Printing	Borderless Printing
		Paper Cassette 1	Paper Cassette 2		
Copy paper Plain paper	A4, Letter, B5, 16K (195×270 mm)	–	100 <sup>*1</sup>	Auto, Manual	–
	A5	–	100 <sup>*1</sup>	Manual	–
	A6, B6	20	20	Manual	–
	Legal, 8.5×13 in.	–	1	Manual	–
	User Defined <sup>*2</sup> (mm) 89x127 to 215.9x1200	–	1	Manual	–

\*1 For manual 2-sided printing, you can load up to 30 sheets for paper with one side already printed.

\*2 Only printing from computer or smart device is available.

## Envelopes

Media Name	Size	Loading Capacity (Envelopes)		2-Sided Printing	Borderless Printing
		Paper Cassette 1	Paper Cassette 2		
Envelope	Envelope #10, Envelope DL, Envelope C6	–	10	–	–

## Related Information

➔ [“Part Names and Functions” on page 16](#)

## List of Paper Types

To obtain optimum printing results, select the paper type that suits the paper.

Media Name	Media Type	
	Control Panel	Printer Driver, Smart device <sup>*2</sup>
Plain paper, Copy paper Epson Bright White Ink Jet Paper <sup>*1</sup>	Plain paper	Plain paper
Epson Ultra Glossy Photo Paper <sup>*1</sup>	Ultra Glossy	Epson Ultra Glossy

## Loading Paper

Media Name	Media Type	
	Control Panel	Printer Driver, Smart device*2
Epson Premium Glossy Photo Paper*1	Prem. Glossy	Epson Premium Glossy
Epson Premium Semigloss Photo Paper*1	Prem. Semigloss	Epson Premium Semigloss
Epson Photo Paper Glossy*1	Glossy	Photo Paper Glossy
Epson Matte Paper-Heavyweight*1 Epson Double-Sided Matte Paper*1	Matte	Epson Matte
Epson Photo Quality Ink Jet Paper*1 Epson Double-sided Photo Quality Ink Jet Paper*1	Photo Quality IJ	Epson Photo Quality Ink Jet
Epson Photo Stickers 16*1	Photo Stickers	Epson Photo Stickers
Epson Iron-On Cool Peel Transfer Paper	Plain paper	Plain paper
Envelope	Envelope	Envelope

\*1: These paper types are compatible with Exif Print and PRINT Image Matching when printing from the printer driver. For more details, see the documentation provided with the Exif Print or PRINT Image Matching compatible digital camera.

\*2: For smart devices, these media types can be selected when printing using Epson iPrint.

## Paper Source Features

This printer has two paper sources. Load paper of the appropriate size and type to suit your printing needs.

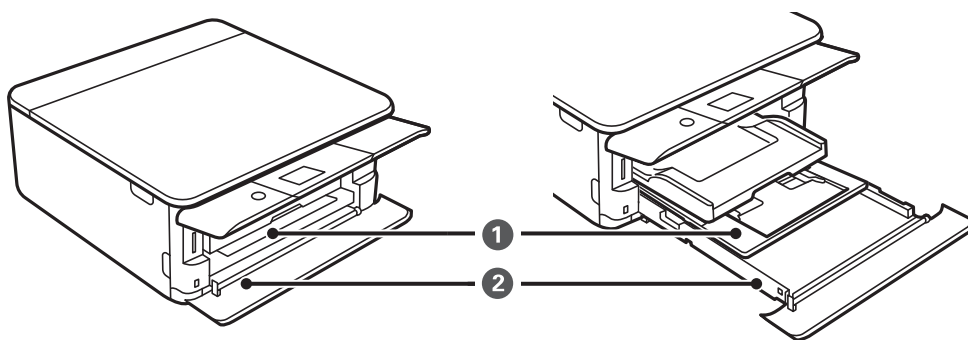

①	Paper cassette 1	<input type="checkbox"/> You can load small size photo paper. <input type="checkbox"/> If you load the same paper in paper cassette 1 and paper cassette 2 and select <b>Cassette 1→2</b> as the <b>Paper Cassettes</b> setting in the print settings, the printer automatically feeds paper from paper cassette 2 when paper runs out in paper cassette 1.
②	Paper cassette 2	We recommend loading A4 size plain paper as this is used frequently.

## Loading Paper

### Related Information

- ➔ [“Loading Paper in the Paper Cassette 1” on page 62](#)
- ➔ [“Loading Paper in the Paper Cassette 2” on page 66](#)

## Loading Paper in the Paper Cassette 1

1. If the output tray is extended, push it back in manually.

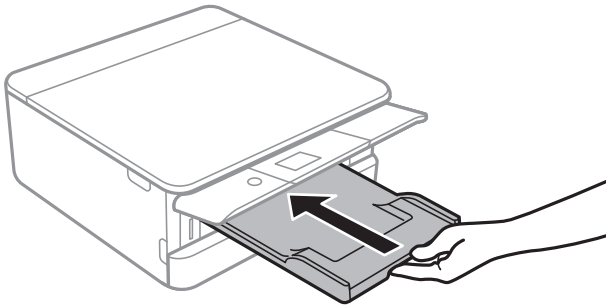

2. Open the front cover until it clicks.

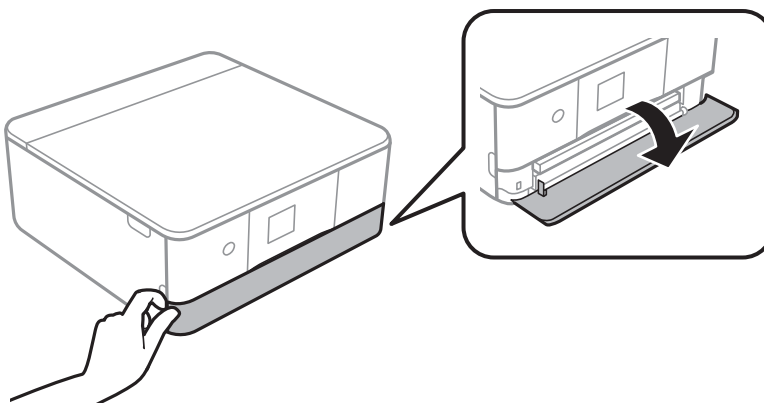

3. Check that the printer is not operating, and then slide out the paper cassette 1.

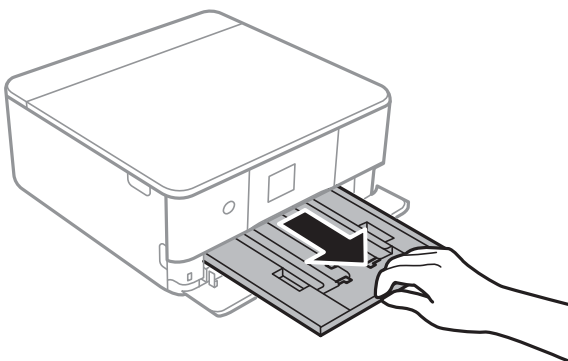

## Loading Paper

**Note:**

- ❑ If paper cassette 1 is at the back and cannot be slid out, you can slide it out by turning the printer off and back on again.
- ❑ You can load paper even if you pull out paper cassette 1 completely. Lift up paper cassette 1 slightly, and then pull it out.

4. Slide the edge guides to their maximum position.

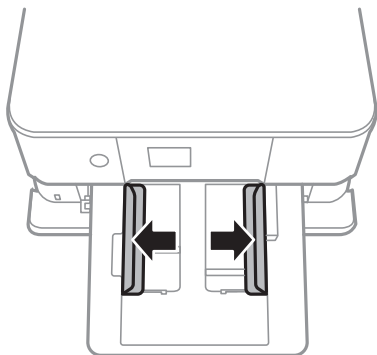

5. With the printable side facing down, load paper until it touches the back of paper cassette 1.

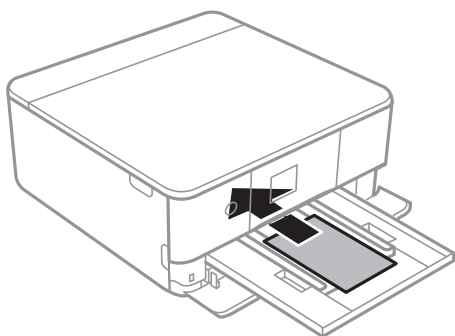

**!** **Important:**

*Do not load different types of paper in the paper cassette.*

Follow the instructions supplied with the stickers to load one sheet of Epson Photo Stickers 16. Do not load the loading support sheets into this product.

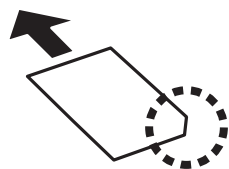

## Loading Paper

- Slide the edge guides to the edges of the paper.

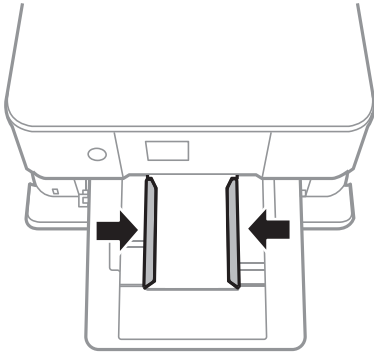

**!** *Important:*

*Do not load more than the maximum number of sheets specified for the paper.*

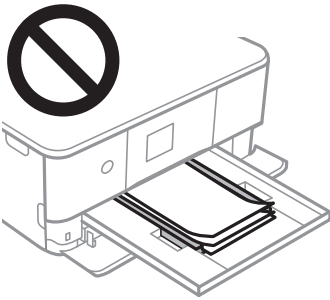

- Gently insert paper cassette 1.

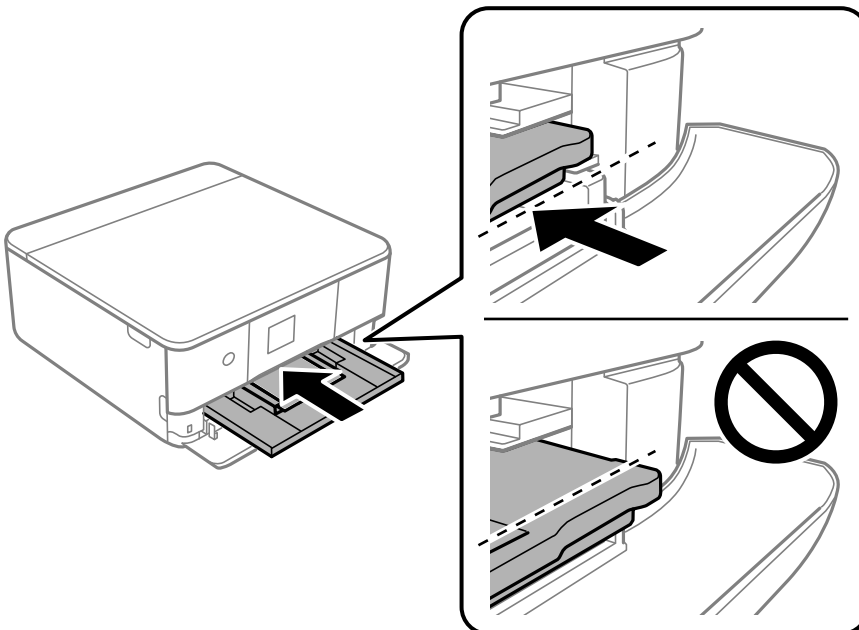



## Loading Paper

8. Raise the control panel.

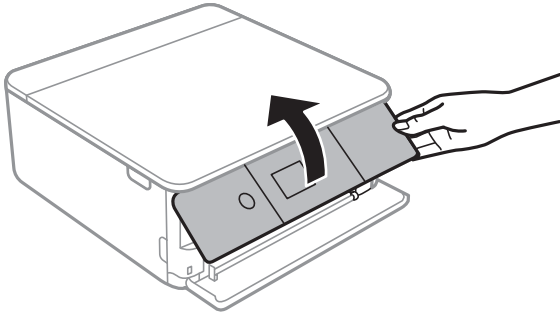

9. Check the paper size and paper type settings displayed on the control panel. To use the settings, select **Done**. To change the settings, select the item that you want to change, and then go to the next step.

To select an item, move the focus to the item using the ▲ ▼ ◀ ▶ buttons, and then press the OK button.

**Note:**

- ❑ *By registering frequently used combinations of paper size and paper type as a favorite, you do not need to set them each time. You can make paper settings just by selecting the registered preset.*

*To register a preset, select **Favorite Paper Settings**, press ▶ on the next screen and then specify the paper size and paper type.*

- ❑ *The paper setting screen is not displayed if you have disabled **Paper Configuration** in the following menus. In this situation, you cannot print from an iPhone or iPad using AirPrint.*

**Settings > Printer Settings > Paper Source Setting > Paper Configuration**

10. Check the settings, and then select **Done**.

11. Slide out the output tray.

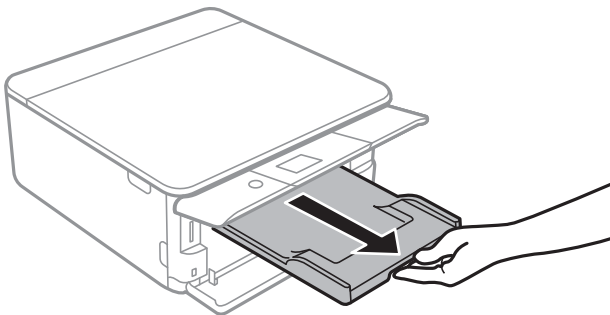

### Related Information

- ➔ [“Paper Handling Precautions” on page 57](#)
- ➔ [“Available Paper and Capacities” on page 58](#)
- ➔ [“Menu Options for Printer Settings” on page 181](#)

## Loading Paper in the Paper Cassette 2

1. If the output tray is extended, push it back in manually.

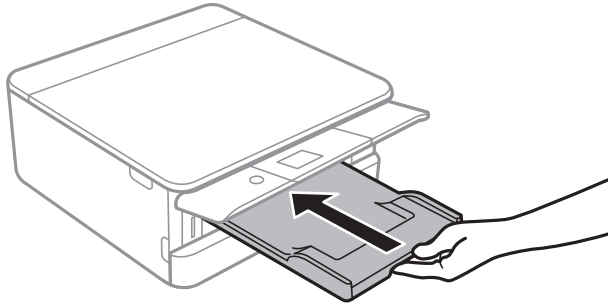

2. Open the front cover until it clicks.

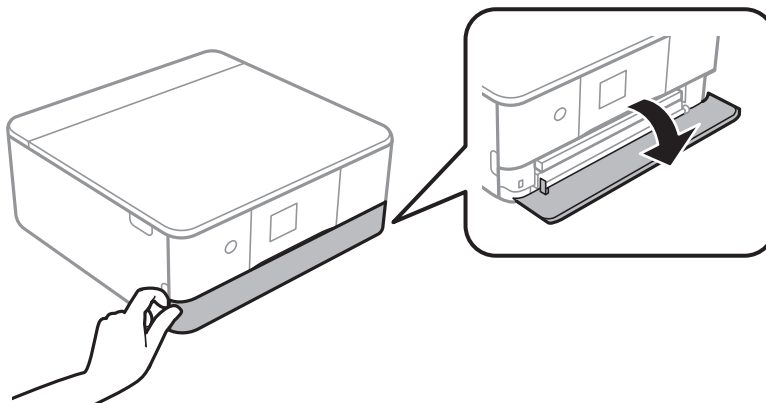

3. Check that the printer is not operating, and then slide out the paper cassette 2.

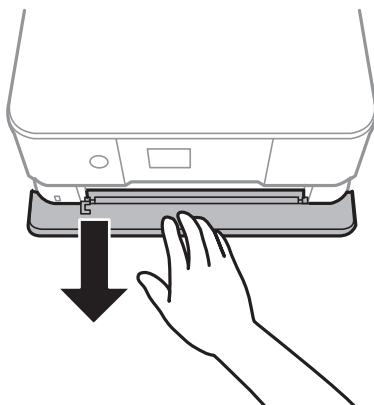

**Note:**

You can load paper even if you pull out paper cassette 2 completely. Lift up paper cassette 2 slightly, and then pull it out.

## Loading Paper

- Slide the edge guides to their maximum position.

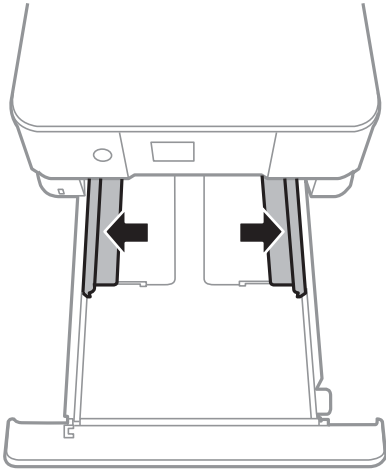

- With the printable side facing down, load paper until it touches the back of paper cassette 2.

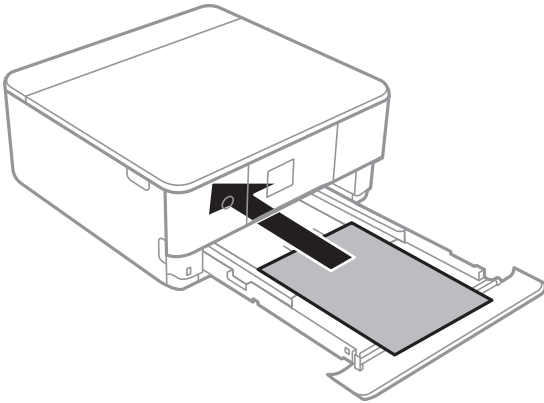

**Important:**

*Do not load different types of paper in the paper cassette.*

Load envelopes or Epson Photo Stickers 16 in the direction indicated by the arrow in the following illustration until they touch the back of paper cassette 2.

- Envelope

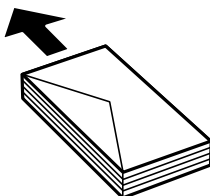

## Loading Paper

❑ Epson Photo Stickers 16

Follow the instructions supplied with the stickers to load one sheet of Epson Photo Stickers 16. Do not load the loading support sheets into this product.

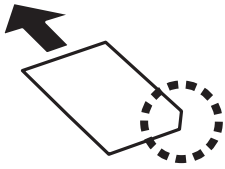

Load paper longer than A4 size as indicated in the following illustration.

❑ 8.5 x 13 in.

Load paper using the line.

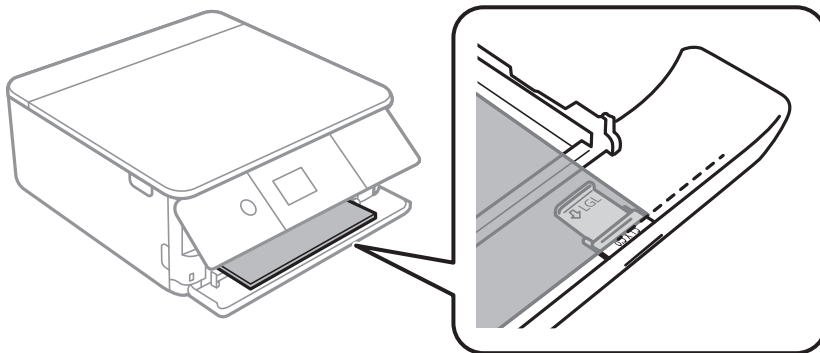

❑ Legal

Pull out the legal paper guide and load paper using the line.

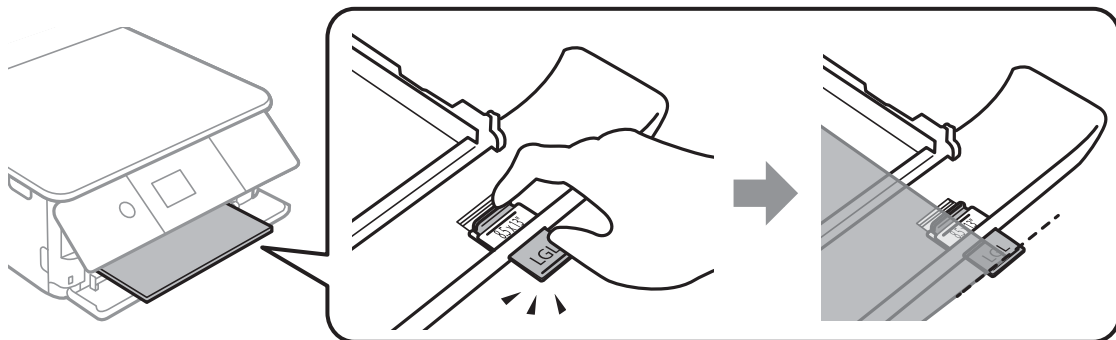

## Loading Paper

**!** *Important:*

*Do not push paper that protrudes from the cassette.*

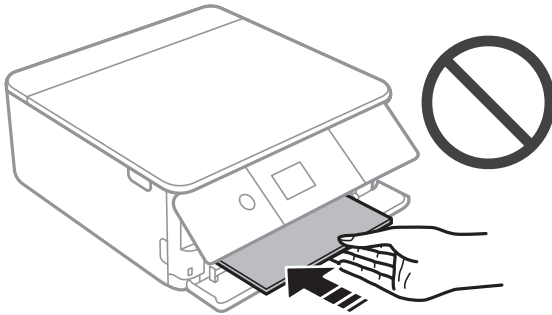

6. Slide the edge guides to the edges of the paper.

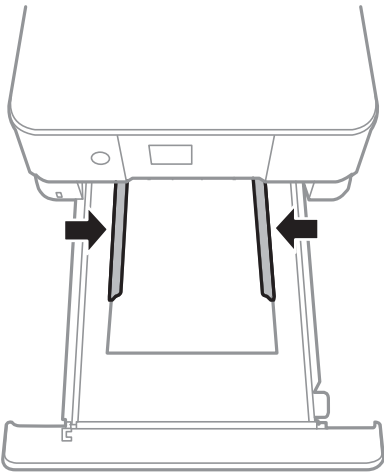

**!** *Important:*

*Do not load more than the maximum number of sheets specified for the paper.*

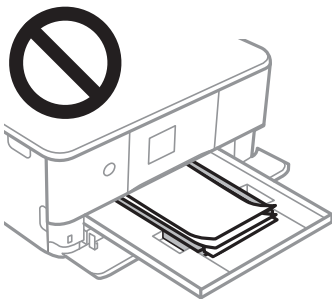

## Loading Paper

7. Gently insert the paper cassette 2 as far as it will go.

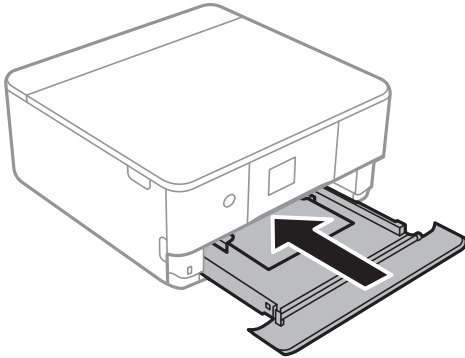

8. Raise the control panel.

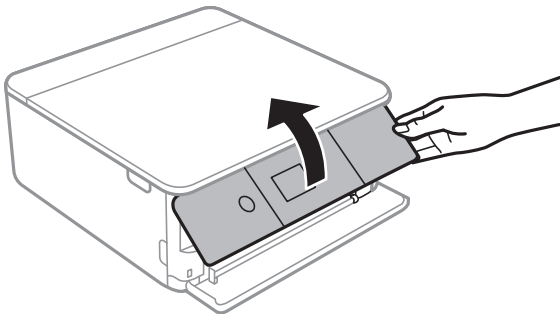

9. Check the paper size and paper type settings displayed on the control panel. To use the settings, select **Done**. To change the settings, select the item that you want to change, and then go to the next step.

To select an item, move the focus to the item using the ▲ ▼ ◀ ▶ buttons, and then press the OK button.

**Note:**

- ❑ By registering frequently used combinations of paper size and paper type as a favorite, you do not need to set them each time. You can make paper settings just by selecting the registered preset.

To register a preset, select **Favorite Paper Settings**, press ► on the next screen and then specify the paper size and paper type.

- ❑ The paper setting screen is not displayed if you have disabled **Paper Configuration** in the following menus. In this situation, you cannot print from an iPhone or iPad using AirPrint.

**Settings > Printer Settings > Paper Source Setting > Paper Configuration**

10. Check the settings, and then select **Done**.

11. Slide out the output tray.

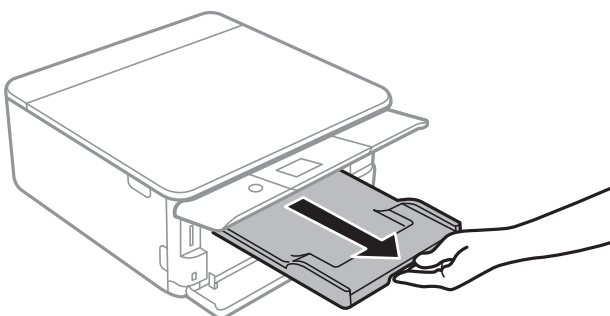

## Loading Paper

### Related Information

- ➔ [“Paper Handling Precautions” on page 57](#)
- ➔ [“Available Paper and Capacities” on page 58](#)
- ➔ [“Menu Options for Printer Settings” on page 181](#)

# Placing Originals

---

## Placing Originals on the Scanner Glass

**!** *Important:*

*When placing bulky originals such as books, prevent exterior light from shining directly onto the scanner glass.*

1. Open the document cover.

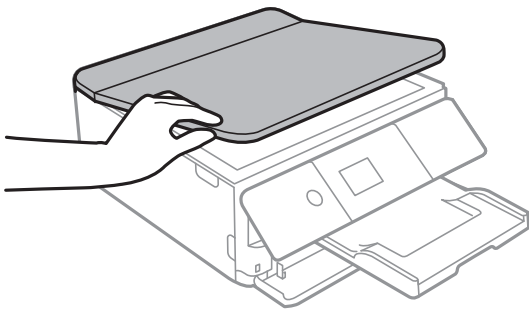

2. Remove any dust or stains on the surface of the scanner glass using a soft, dry, clean cloth.

**Note:**

*If there is any trash or dirt on the scanner glass, the scanning range may expand to include it, so the image of the original may be displaced or reduced.*

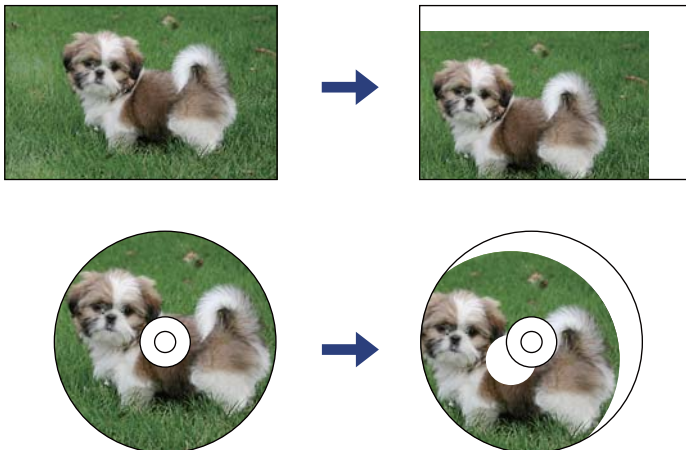



## Placing Originals

- Place the original face-down and slide it to the corner mark.

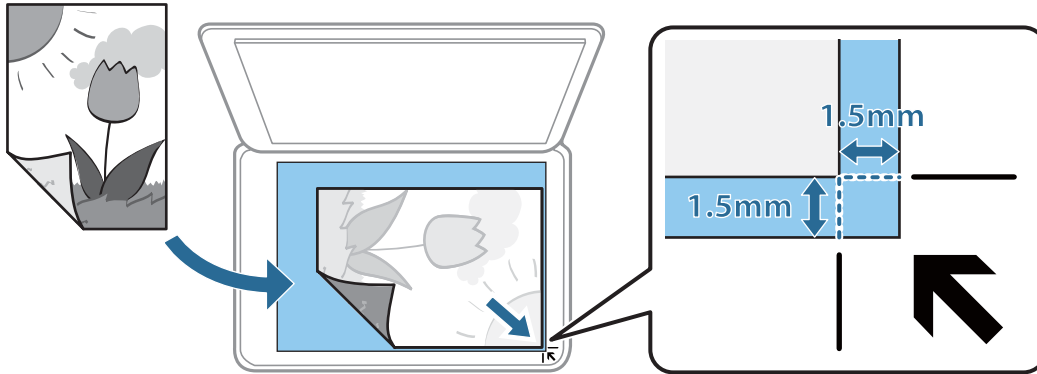

**Note:**

A range of 1.5 mm from the corner of the scanner glass is not scanned.

- Close the cover gently.



**Important:**

Do not apply too much force to the scanner glass or the document cover. Otherwise, they may be damaged.

- Remove the originals after scanning.

**Note:**

If you leave the originals on the scanner glass for a long time, they may stick to the surface of the glass.

---

## How to Place Various Originals

### Placing Photos for Copying

You can place multiple photos at a time to make separate copies. The photos should be larger than 30×40 mm. Place a photo 5 mm away from the corner mark of the scanner glass, and leave 5 mm between photos. You can place photos of different sizes at the same time.

Maximum size: 10×15 cm (4×6 in.)

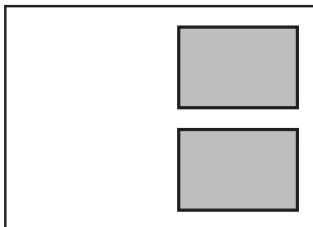

## Placing Originals

### Placing an ID Card for Copying

Place an ID card 5 mm away from the corner mark of the scanner glass.

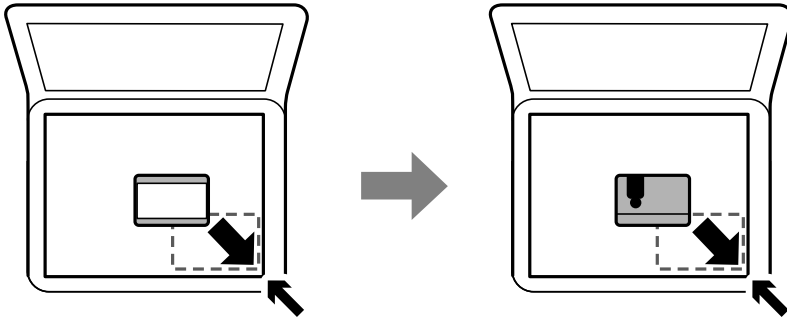

### Placing a CD/DVD for Copying Labels

Place a CD/DVD in the center of the scanner glass. If the CD/DVD is not placed exactly in the center, the positioning is automatically adjusted.

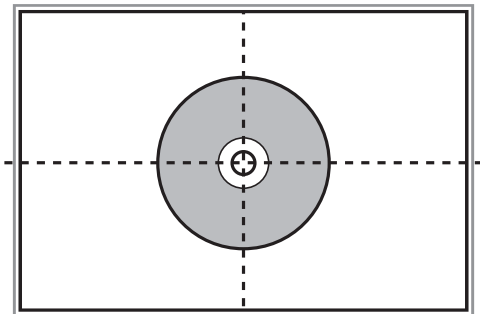

### Placing Multiple Photos for Scanning at the Same Time

You can scan multiple photos at the same time and save each image, using **Photo Mode** in Epson Scan 2. Place the photos 4.5 mm away from the horizontal and vertical edges of the scanner glass, and place them at least 20 mm apart from each other. The photos should be larger than 15×15 mm.

## Placing Originals

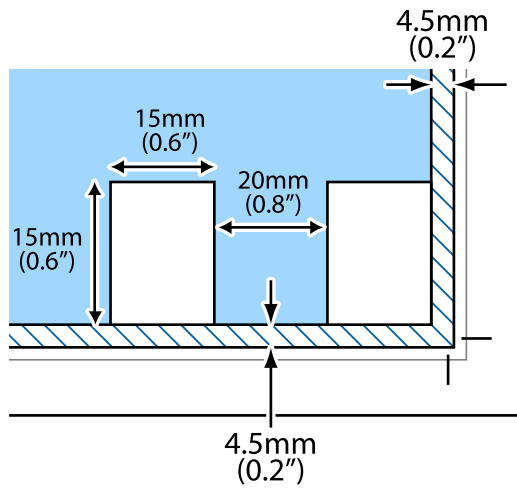

**Note:**

Enable the **Thumbnail** check box at the top of the preview window.

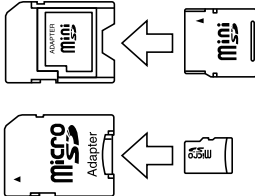

# Inserting a Memory Card

## Supported Memory Cards

	<ul style="list-style-type: none"> <li>miniSD*</li> <li>miniSDHC*</li> <li>microSD*</li> <li>microSDHC*</li> <li>microSDXC*</li> </ul>
	<ul style="list-style-type: none"> <li>SD</li> <li>SDHC</li> <li>SDXC</li> </ul>

\* Attach an adapter to fit the memory card slot. Otherwise, the card may get stuck.

### Related Information

➔ [“Supported Memory Card Specifications” on page 240](#)

## Inserting and Removing a Memory Card

1. Raise the control panel.

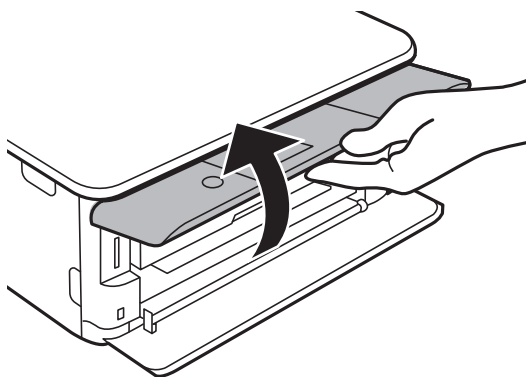

2. Insert a memory card into the printer.

The printer starts reading the data and the light flashes. When reading is complete, the light stops flashing and remains on.

## Inserting a Memory Card

**!** *Important:*

*Insert a memory card straight into the printer.*

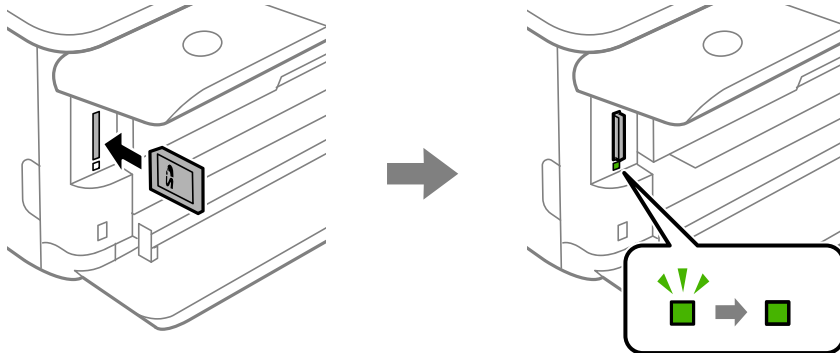

3. When you have finished using the memory card, make sure the light is not flashing, and then push the card to remove it.

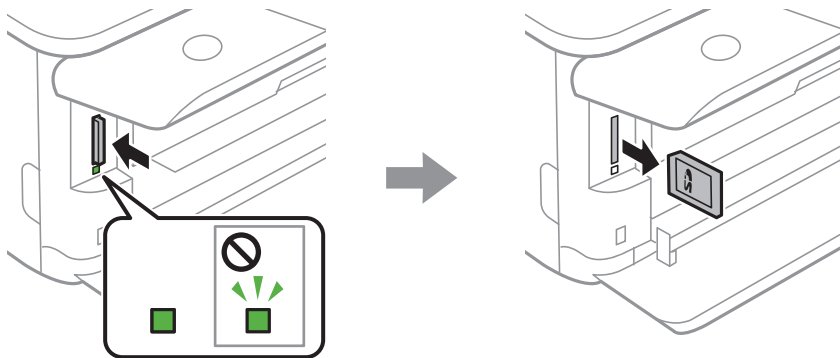

**!** *Important:*

*If you remove the memory card while the light is flashing, the data in the memory card may be lost.*

**Note:**

*If you access the memory card from a computer, you need to operate the computer to safely remove the removable device.*

### Related Information

➔ [“Accessing a Memory Card From a Computer” on page 248](#)

# Loading a CD/DVD for Printing

---

## Printable CD/DVDs

You can print on a circular 12-cm CD/DVD labelled as suitable for printing, for example "printable on the label surface" or "printable with ink jet printers."

You can also print on Blu-ray Discs™.

---

## CD/DVD Handling Precautions

- ❑ See the documentation provided with your CD/DVD for more information on handling the CD/DVD or writing data.
- ❑ Do not print on the CD/DVD before writing your data to it. If you do, fingerprints, dirt, or scratches on the surface may cause errors while writing data.
- ❑ Depending on the CD/DVD type or printing data, smearing may occur. Try making a test print on a spare CD/DVD. Check the printed surface after waiting for one full day.
- ❑ Compared to printing on genuine Epson paper, the print density is lowered to prevent ink from smearing on the CD/DVD. Adjust the print density as necessary.
- ❑ Allow the printed CD/DVDs at least 24 hours to dry avoiding direct sunlight. Do not stack or insert the CD/DVDs into your device until they are completely dry.
- ❑ If the printed surface is sticky even after it has dried, lower the print density.
- ❑ Reprinting on the same CD/DVD may not improve the print quality.
- ❑ If the CD/DVD tray or the internal transparent compartment are accidentally printed on, immediately wipe off the ink.
- ❑ Depending on the print area setting, the CD/DVD or CD/DVD tray may get dirty. Make settings to print on the printable area.
- ❑ You can set the print range for the CD/DVD to a minimum of 18 mm for the inner diameter, and a maximum of 120 mm for the outer diameter. Depending on the settings, the CD/DVD or tray may be smeared. Set within the print range for the CD/DVD you want to print.

### Related Information

➔ [“Printable Area for CD/DVD” on page 238](#)

---

## Loading and Removing a CD/DVD

When printing on or copying a CD/DVD, instructions are displayed on the control panel informing you when to load the CD/DVD. Follow the on-screen instructions.

### Related Information

➔ [“Printing Photos onto a CD/DVD Label” on page 93](#)

## Loading a CD/DVD for Printing

➔ [“Copying on a CD/DVD Label” on page 130](#)

# Printing

## Printing from the Print Photos Menu on the Control Panel

You can print data from a memory device such as memory card or external USB device.

### Basic Operations for Printing Photos

1. Load paper in the printer.
2. Insert a memory device into the SD card slot or the external interface USB port of the printer.

If **Auto Selection Mode** in **Guide Functions** is turned on, a message is displayed. Check the message and press the OK button.

3. Select **Print Photos** on the control panel.

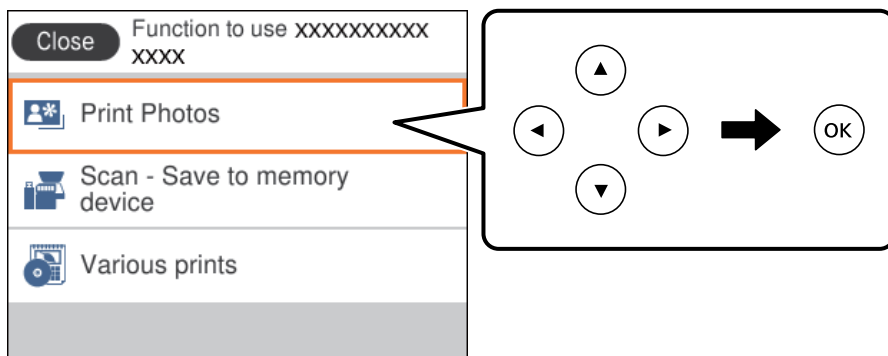

To select an item, move the focus to the item using the ▲ ▼ ◀ ▶ buttons, and then press the OK button.

4. Select **Print**.
5. When a message telling you that loading photos is complete is displayed, press the OK button.
6. Select the photo you want to print on the select photo screen.

**Note:**

Select  at the top right of the screen to display the **Select Photo Menu**. If you specify a date by using **Browse**, only photos of the specified date are displayed.

7. Set the number of prints using the - or + button.

When printing more than one photo, display the photos using the ◀ or ▶ button, and then set the number of prints.

8. Select **Print Settings** to make paper and print settings.



## Printing

9. Press the ► button.
10. Press the ↻ button to edit the photos as necessary.
11. Slide out the output tray.
12. Enter the number of copies, and then press the ◊ button.
13. Confirm that printing is complete, and then select **Close**.

If you notice print quality problems such as banding, unexpected colors, or blurry images, select **Troubleshooting** to see the solutions.

### Related Information

- ➔ “Loading Paper in the Paper Cassette 1” on page 62
- ➔ “Loading Paper in the Paper Cassette 2” on page 66
- ➔ “List of Paper Types” on page 60
- ➔ “Inserting a Memory Card” on page 76
- ➔ “Guide to the Select Photo Screen (Single View)” on page 82
- ➔ “Menu Options for Selecting Photos” on page 87
- ➔ “Guide to the Select Photo Screen (Single View)” on page 82
- ➔ “Menu Options for Paper and Print Settings” on page 88
- ➔ “Guide to the Preview Screen” on page 83
- ➔ “Guide to the Edit Photo Screen” on page 83
- ➔ “Menu Options for Editing Photos” on page 89

## Guide to the Select Photo Screen (Tile View)

You can select photos from the thumbnail screen. This is useful when selecting a few photos from a large number of photos.

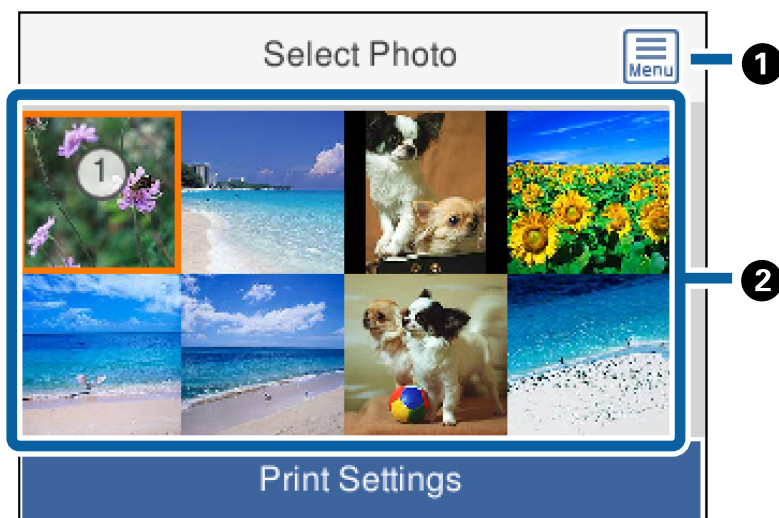

## Printing

①	Displays the <b>Select Photo Menu</b> that allows you to select photos easily.
②	Move the cursor to a photo, and then press the + button to select it. The selected photos have the number of prints on them.

### Guide to the Select Photo Screen (Single View)

Here you can view enlarged photos one by one. Press the ◀ or ▶ button to see the previous or next photo. If you want to display a photo without icons, press the 🔄 button. Press this button again to restore the icons.

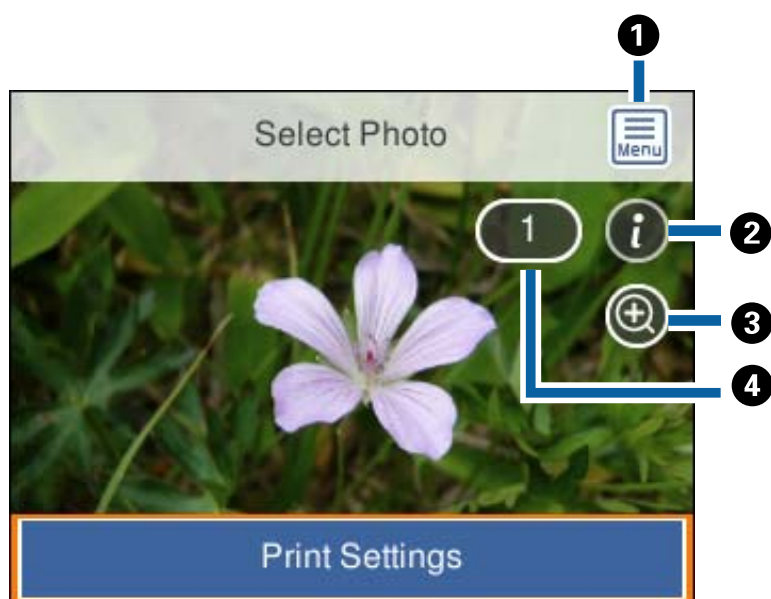

①	Displays the <b>Select Photo Menu</b> that allows you to select photos easily.
②	Displays Exif information such as the shooting date or shutter speed.
③	Enlarges a photo. Press the + button to enlarge the photo and press the ▲ ▼ ◀ ▶ buttons to display the part you want to check. Press the OK button to return to the original view. Enlargement on this screen does not change the print result.
④	Sets the number of prints by pressing the - or + button.

### Related Information

➔ [“Menu Options for Selecting Photos” on page 87](#)

## Printing

### Guide to the Preview Screen

Press the ◀ or ▶ button to see the previous or next photo. Press the ↻ button to display the edit photo screen where you can crop the photo or apply color corrections.

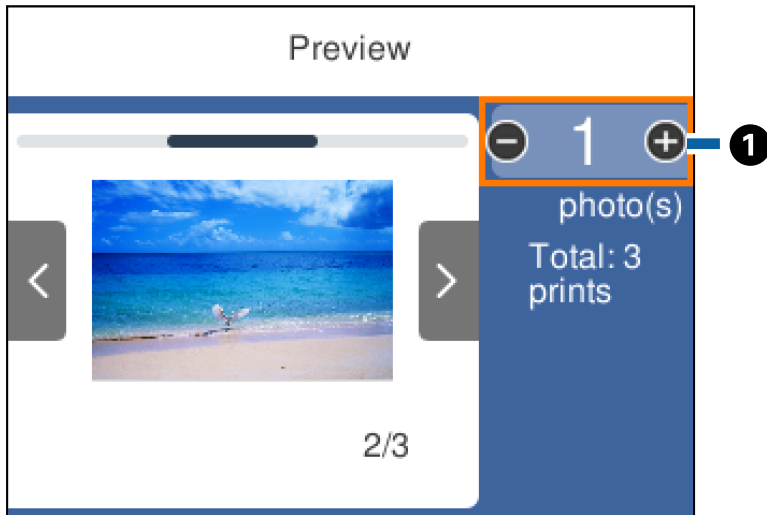

①

Set the number of copies by pressing the - or + button. You can also set the number of copies by using the on-screen keypad. Move the focus to the value, and then press the OK button to display the keypad.

If the value does not change, you cannot set the number of copies on this screen.

#### Related Information

➔ [“Guide to the Edit Photo Screen” on page 83](#)

### Guide to the Edit Photo Screen

You can crop or rotate the photo or apply color correction. Switch between **Correction Off** and **Correction On** using the ↻ button. When **Correction On** is selected, the color correction adjusted on the **Edit** screen becomes

## Printing

visible on the screen. When **Correction Off** is selected, the color correction remains invisible, but the correction is applied on the printout.

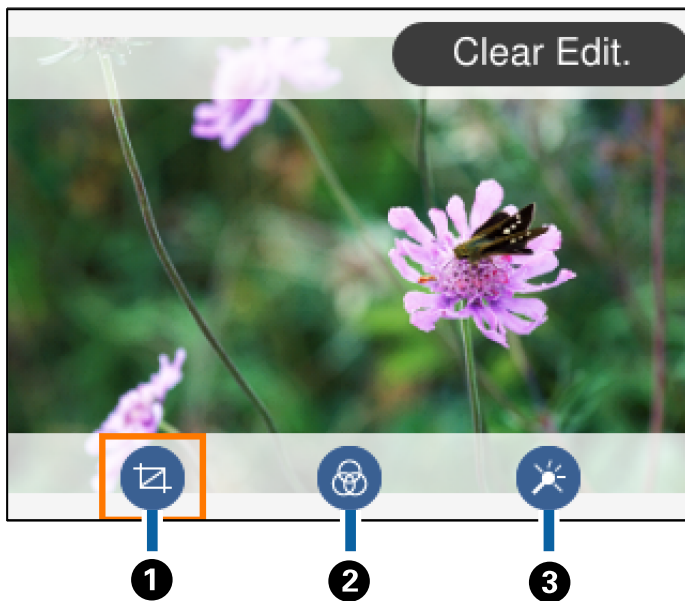

①	Adjusts the cropping area. You can move the frame to the area you want to crop using the ▲▼◀▶ buttons, or change the size of the frame using the - and + buttons. You can also rotate the frame using the ↻ button.
②	Prints in sepia or monochrome.
③	Applies color correction. You can select the level of correction for certain items using the + and - buttons.

### Related Information

➔ [“Menu Options for Editing Photos” on page 89](#)

## Printing in Various Layouts

You can print the photos on your memory device in various layouts such as 2-up and 4-up. Photos are placed automatically.



1. Load paper in the printer.
2. Insert a memory device into the SD card slot or the external interface USB port of the printer.

## Printing

3. Select **Print Photos** on the control panel.

To select an item, move the focus to the item using the ▲ ▼ ◀ ▶ buttons, and then press the OK button.

4. Select **Print Layout**.
5. Select the layout.
6. Make paper and print settings.
7. Press the ▶ button.
8. When a message telling you that loading photos is complete is displayed, press the OK button.
9. Select the photo you want to print on the select photo screen.
10. Select **Preview and Print**.
11. Press the  button to edit the photos as necessary.
12. Enter the number of copies, and then press the ◊ button.

### Related Information

- ➔ [“Loading Paper in the Paper Cassette 1” on page 62](#)
- ➔ [“Loading Paper in the Paper Cassette 2” on page 66](#)
- ➔ [“List of Paper Types” on page 60](#)
- ➔ [“Inserting a Memory Card” on page 76](#)
- ➔ [“Menu Options for Paper and Print Settings” on page 88](#)
- ➔ [“Guide to the Select Photo Screen \(Single View\)” on page 82](#)
- ➔ [“Menu Options for Selecting Photos” on page 87](#)
- ➔ [“Guide to the Select Photo Screen \(Single View\)” on page 82](#)
- ➔ [“Guide to the Preview Screen” on page 83](#)
- ➔ [“Guide to the Edit Photo Screen” on page 83](#)
- ➔ [“Menu Options for Editing Photos” on page 89](#)

## Printing ID Photos



You can print ID photos using data on a memory device. Two copies of one photo are printed at two different sizes, 50.8×50.8 mm and 45.0×35.0 mm, on 10×15 cm (4×6 in.) size photo paper.

1. Load paper in the printer.
2. Insert a memory device into the SD card slot or the external interface USB port of the printer.
3. Select **Print Photos** on the control panel.

To select an item, move the focus to the item using the ▲ ▼ ◀ ▶ buttons, and then press the OK button.

4. Select **Print photo ID**.

## Printing

5. When a message telling you that loading photos is complete is displayed, press the OK button.
6. Select the photo you want to print on the select photo screen.
7. Select **Print Settings** to make paper and print settings.
8. Press the  button, and then confirm the settings.
9. Press the  button to edit the photos as necessary.
10. Enter the number of copies, and then press the  button.





### Related Information

- ➔ [“Loading Paper in the Paper Cassette 1” on page 62](#)
- ➔ [“Loading Paper in the Paper Cassette 2” on page 66](#)
- ➔ [“List of Paper Types” on page 60](#)
- ➔ [“Inserting a Memory Card” on page 76](#)
- ➔ [“Guide to the Select Photo Screen \(Single View\)” on page 82](#)
- ➔ [“Menu Options for Selecting Photos” on page 87](#)
- ➔ [“Guide to the Select Photo Screen \(Single View\)” on page 82](#)
- ➔ [“Menu Options for Paper and Print Settings” on page 88](#)
- ➔ [“Guide to the Preview Screen” on page 83](#)
- ➔ [“Guide to the Edit Photo Screen” on page 83](#)
- ➔ [“Menu Options for Editing Photos” on page 89](#)

## Printing Photos with a Template

You can print the photos on your memory device in various layouts such as 2-up, 4-up, and upper half. You can select where to place the photos.



1. Load paper in the printer.
2. Insert a memory device into the SD card slot or the external interface USB port of the printer.
3. Select **Print Photos** on the control panel.

To select an item, move the focus to the item using the     buttons, and then press the OK button.

4. Select **Print with template**.
5. Select the layout.
6. Make print settings.
7. Press the  button.
8. When a message telling you that loading photos is complete is displayed, press the OK button.

## Printing

9. Do one of the following.
  - When you select single photo layout in step 5: Select one photo on the select photo screen, select **Preview and Print**, and then go to step 15.
  - When you select multiple photo layout in step 5 and place photos automatically: Select **Automatic Layout**, select photos on the select photo screen, select **Preview and Print**, and then go to step 15.
  - When you select multiple photo layout and place photos manually: Go to step 10.
10. Select .
11. Select the photo you want to print on the select photo screen, and then select **To place photo**.
12. Check the message, and then select **Dismiss**.
13. If you want to edit the photo, select the photo, and then select **Edit Photos**.
 

*Note:*  
When you have finished editing, select **Done** to return to the **Place Photos** screen.
14. Repeat steps 10 to 13 until all photos are placed, and then press the  button.
15. Press the  button to edit the photos as necessary.
16. Enter the number of copies, and then press the  button.

### Related Information

- ➔ [“Loading Paper in the Paper Cassette 1” on page 62](#)
- ➔ [“Loading Paper in the Paper Cassette 2” on page 66](#)
- ➔ [“List of Paper Types” on page 60](#)
- ➔ [“Inserting a Memory Card” on page 76](#)
- ➔ [“Menu Options for Paper and Print Settings” on page 88](#)
- ➔ [“Guide to the Select Photo Screen \(Single View\)” on page 82](#)
- ➔ [“Guide to the Preview Screen” on page 83](#)
- ➔ [“Guide to the Edit Photo Screen” on page 83](#)
- ➔ [“Menu Options for Editing Photos” on page 89](#)

## Menu Options for Printing from the Control Panel

### Menu Options for Selecting Photos

Browse:

Displays the photos on the memory device sorted using specified conditions. Available options depend on the features being used.

- Cancel Browse:

Cancels sorting photos and displays all the photos.

## Printing

yyyy:

Select the year of the photos you want to display.

yyyy/mm:

Select the year and month of the photos you want to display.

yyyy/mm/dd:

Select the year, month, and date of the photos you want to display.

Display order:

Changes the display order of photos in ascending or descending order.

Select all photos:

Selects all the photos and sets the number of prints.

Deselect all photos:

Returns the number of prints of all photos to 0 (zero).

Select a device to load photos:

Select the device from which you want to load photos.

## Menu Options for Paper and Print Settings

Paper Size:

Select the paper size you loaded.

Paper Type:

Select the paper type you loaded.

Paper Cassettes:

Select the paper source that you want to use.

Border Setting

Borderless:

Prints without margins around the edges. The image is enlarged a little to remove borders from the edges of the paper.

With Border:

Prints with white margins around the edges.

Expansion:

With borderless printing, the image is enlarged a little to remove borders from the edges of the paper. Select how much to enlarge the image.

Fit Frame:

If the aspect ratio of the image data and the paper size is different, the image is automatically enlarged or reduced so that the short sides match the short sides of the paper. The long side of the image is cropped if it extends beyond the long side of the paper. This feature may not work for panorama photos.



## Printing

### Quality:

Select the print quality. Selecting **Best** provides higher quality printing, but the printing speed may be slower.

### Date:

Select the format used to print the date on photos for photos that include the date the photos were taken or the date they were saved. The date is not printed for some layouts.

### Print Info. On Photos

Off:

Prints without any information.

Camera Settings:

Prints with some Exif information, such as shutter speed, f-ratio, or ISO sensitivity. Unrecorded information is not printed.

Camera Text:

Prints text set on the digital camera. For information on the text settings, see the documentation provided with your camera. The information can only be printed in borderless printing on 10×15 cm, 13×18 cm, or 16:9 wide size.

Landmark:

Prints the name of the place or landmark where the photo was taken for digital cameras that have the landmark feature. See the website of the manufacturer of your camera for more details. The information can only be printed in borderless printing on 10×15 cm, 13×18 cm, or 16:9 wide size.

### Clear All Settings:

Resets the paper and print settings to their defaults.

### CD Density:

For CD/DVD printing. Set the density to use when printing onto a CD/DVD.

### Density:

For coloring book printing. Select the level of density for the outlines on the coloring sheet.

### Line Detection:

For coloring book printing. Select the sensitivity used to detect outlines in the photo.

## Menu Options for Editing Photos



(Crop):

Crops a part of the photo. You can move, enlarge, or reduce the cropping area.



(Filter):

Prints in sepia or monochrome.



(Adjustments):

Applies color corrections using the **Enhance** or **Fix Red-Eye** feature.

## Printing

### Enhance:

Select one of the image adjustment options. **Auto**, **People**, **Landscape**, or **Night Scene** produces sharper images and more vivid colors by automatically adjusting the contrast, saturation, and brightness of the original image data.

Auto:

The printer detects the image content and automatically enhances the image according to the detected content.

People:

Recommended for images of people.

Landscape:

Recommended for images of landscape or scenery.

Night Scene:

Recommended for images of night scenes.

P.I.M.:

Adjusts the image based on the printing information provided by a digital camera compatible with PRINT Image Matching.

Enhance Off:

Turns off the **Enhance** feature.

### Fix Red-Eye:

Fixes red-eye in photos. Corrections are not applied to the original file, only to the printouts. Depending on the type of photo, parts of the image other than the eyes may be corrected.

### Brightness:

Adjusts the brightness of the image.

### Contrast:

Adjusts the difference between the brightness and darkness.

### Sharpness:

Enhances or defocuses the outline of the image.

### Saturation:

Adjusts the vividness of the image.

---

## Printing from the Various prints Menu on the Control Panel

### Printing Design Paper

You can print a variety of design paper by using the patterns stored in the printer, such as borders and polka dots. This allows you to use the paper in a variety of ways, such as creating homemade book covers, wrapping paper, and so on. Visit the following website for details on how you can create your own items.

## Printing

<http://epson.sn>



1. Load paper in the printer.
2. Select **Various prints** on the control panel.  
To select an item, move the focus to the item using the ▲ ▼ ◀ ▶ buttons, and then press the OK button.
3. Select **Design Paper**.
4. Select the pattern, such as borders or polka dots.
5. Make paper and print settings.
6. Press the ▶ button
7. Enter the number of copies, and then press the ◊ button.

### Related Information

- ➔ “Loading Paper in the Paper Cassette 2” on page 66
- ➔ “List of Paper Types” on page 60

## Printing Photos with Handwritten Notes

You can print a photo on a memory device with handwritten text or drawings. This allows you to create original cards such as New Year's cards or birthday cards.

First select a photo and print a template on plain paper. Write or draw on the template and then scan it with the printer. You can then print the photo with your own personal notes and drawings.

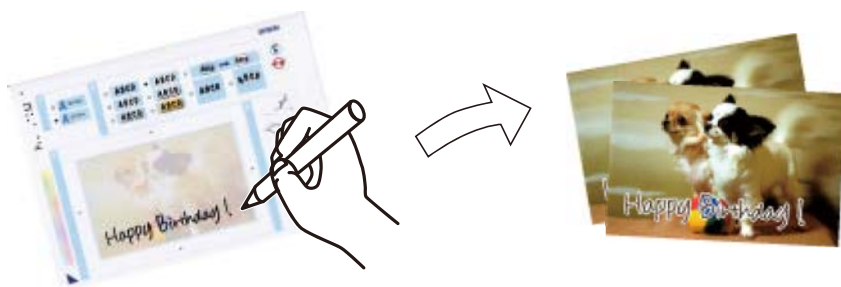

## Printing

1. Insert a memory device into the SD card slot or the external interface USB port of the printer.



**Important:**

*Do not remove the memory device until you have finished printing.*

2. Select **Various prints** on the control panel.

To select an item, move the focus to the item using the ▲ ▼ ◀ ▶ buttons, and then press the OK button.

3. Select **Greeting Card > Select Photo and Print Template**.

4. When a message telling you that loading photos is complete is displayed, press the OK button.

5. Select the photo you want to print on the select photo screen, and then select **Print Settings**.

6. Make print settings such as the paper type or layout for printing a photo with handwritten notes, and then press the ▶ button.

7. Load A4-size plain paper in paper cassette 2 to print a template.

8. Select **To Check Printing**.

9. Press the ◊ button to print a template.

10. Check the printout, and then select **Close**.

11. Follow the instructions on the template to write and draw.

12. Store the output tray by hand. Load photo paper in paper cassette 1.

13. Select **Print Using the Template**.

14. Check the screen, place the template on the scanner glass, and then press the OK button.

**Note:**

*Make sure that the text on the template is completely dry before placing it on the scanner glass. If there are stains on the scanner glass, the stains are also printed on the photo.*

15. Press the  button to edit the photos as necessary.

16. Slide out the output tray.

17. Enter the number of copies, and then press the ◊ button.

### Related Information

- ➔ [“Inserting a Memory Card” on page 76](#)
- ➔ [“Guide to the Select Photo Screen \(Single View\)” on page 82](#)
- ➔ [“Menu Options for Paper and Print Settings” on page 88](#)
- ➔ [“Loading Paper in the Paper Cassette 1” on page 62](#)
- ➔ [“Loading Paper in the Paper Cassette 2” on page 66](#)
- ➔ [“List of Paper Types” on page 60](#)

## Printing

- ➔ “Placing Originals on the Scanner Glass” on page 72
- ➔ “Guide to the Edit Photo Screen” on page 83
- ➔ “Menu Options for Editing Photos” on page 89

### Printing Photos onto a CD/DVD Label



You can select photos stored on a memory device to print onto a CD/DVD label.

**!** **Important:**

- Before printing on the CD/DVD, see the CD/DVD handling precautions.
- Do not insert the CD/DVD tray while the printer is operating. This may damage the printer.
- Do not insert the CD/DVD tray until you are instructed to do so. Otherwise, an error occurs and the CD/DVD is ejected.

1. Insert a memory device into the SD card slot or the external interface USB port of the printer.
2. Select **Various prints** on the control panel.  
To select an item, move the focus to the item using the ▲ ▼ ◀ ▶ buttons, and then press the OK button.
3. Select **Copy to CD/DVD > Print on CD/DVD**.
4. Select the layout.  
**CD/DVD 1-up**, **CD/DVD 4-up**, and **CD/DVD Variety** are available.
5. When a message telling you that loading photos is complete is displayed, select **Dismiss**.
6. Do one of the following.
  - CD/DVD 1-up**: Select a photo, select **Proceed to set up Outer/Inner.**, and then go to step 10.
  - CD/DVD 4-up**: Go to step 7.
  - CD/DVD Variety**: Select photos until the number of photos that can be set reaches 0. Select **Proceed to set up Outer/Inner.**, and then go to step 10.
7. Select **+**, select the photo you want to place, and then select **To place photo**.
8. Check the message, and then press the OK button. If necessary, select the photo to edit it.
9. Repeat steps 7 and 8 until photos are placed in all of the portions, and then press the **⌂** button.

## Printing

- Move the focus to the outer diameter, and then press the - or + button to adjust the value. Adjust the inner diameter in the same manner.

You can also set the diameter by selecting the value in the frame and using the on-screen keypad.

**Note:**

- ❑ You can set 114 to 120 mm as the outer diameter, and 18 to 46 mm as the inner diameter in 1 mm increments.
- ❑ The inner diameter and the outer diameter you set are restored to their defaults after printing the disc label. You can change the defaults in **Settings > Printer Settings > CD Inner/Outer**.

- Select **Select Type**.

- Select **Print on CD/DVD**.

**Note:**

For test printing, select **Test print on A4 paper**, and then load A4 plain paper in paper cassette 2. You can check the printout image before printing on a CD/DVD label.

- When the message prompts you to load a CD/DVD, select **How To**, and load a CD/DVD by referring to the instructions.

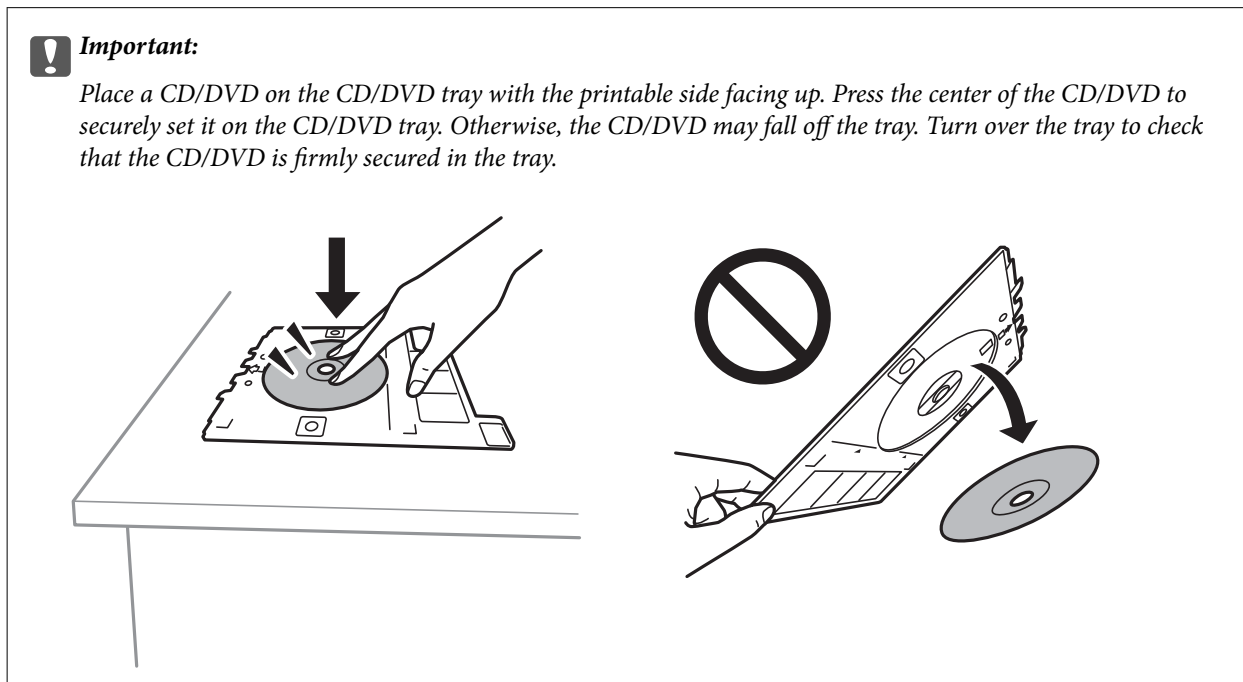

**Note:**

You may feel slight friction when inserting the tray into the printer. This is normal and you should continue to insert it horizontally.

- Select **Installed**.

- Press the  button to edit the photos as necessary.

- Press the  button.

## Printing

- When printing has finished, the CD/DVD tray is ejected. Remove the tray from the printer, and then select **Close**.



### **Important:**

*After printing is finished, make sure you remove the CD/DVD tray. If you do not remove the tray and turn the printer on or off, or run head cleaning, the CD/DVD tray will strike the print head and may cause the printer to malfunction.*

- Remove the CD/DVD and store the CD/DVD tray on the bottom of paper cassette 2.

### **Related Information**



- ➔ [“Inserting a Memory Card” on page 76](#)
- ➔ [“Guide to the Select Photo Screen \(Single View\)” on page 82](#)
- ➔ [“Menu Options for Editing Photos” on page 89](#)

## Printing Photos onto a Jewel Case Jacket

You can easily print photos onto a jewel case jacket using a photo on your memory device. Print the jacket on A4-size paper, and then cut it to fit in the jewel case.

- Load paper in the printer.
- Insert a memory device into the SD card slot or the external interface USB port of the printer.
- Select **Various prints** on the control panel.

To select an item, move the focus to the item using the ▲ ▼ ◀ ▶ buttons, and then press the OK button.

- Select **Copy to CD/DVD > Print on Jewel Case**.
- Select the layout.
- Make paper and print settings.
- Press the ▶ button.
- When a message telling you that loading photos is complete is displayed, press the OK button.
- Select the photo you want to print on the select photo screen.
- Select **Preview and Print**.
- Press the  button to edit the photos as necessary.
- Press the  button.

### **Related Information**

- ➔ [“Loading Paper in the Paper Cassette 2” on page 66](#)
- ➔ [“List of Paper Types” on page 60](#)

## Printing

- ➔ “Inserting a Memory Card” on page 76
- ➔ “Menu Options for Paper and Print Settings” on page 88
- ➔ “Guide to the Select Photo Screen (Single View)” on page 82
- ➔ “Menu Options for Selecting Photos” on page 87
- ➔ “Guide to the Select Photo Screen (Single View)” on page 82
- ➔ “Guide to the Preview Screen” on page 83
- ➔ “Guide to the Edit Photo Screen” on page 83
- ➔ “Menu Options for Editing Photos” on page 89

## Printing Original Calendars with a Photo

You can easily print original calendars with a photo from a memory device.



1. Load paper in the printer.
2. Insert a memory device into the SD card slot or the external interface USB port of the printer.
3. Select **Various prints** on the control panel.  
To select an item, move the focus to the item using the ▲ ▼ ◀ ▶ buttons, and then press the OK button.
4. Select **Calendar**.
5. Select the type of calendar.
6. Make the paper settings, and then press the ▶ button to set the date.
7. Set the year and month, and then select **Done**.
8. When a message telling you that loading photos is complete is displayed, press the OK button.
9. Select the photo you want to print on the select photo screen.
10. Select **Preview and Print**.
11. Press the  button to edit the photo as necessary.



## Printing

- Enter the number of copies, and then press the  button.







### Related Information

- ➔ “Loading Paper in the Paper Cassette 2” on page 66
- ➔ “List of Paper Types” on page 60
- ➔ “Inserting a Memory Card” on page 76
- ➔ “Menu Options for Paper and Print Settings” on page 88
- ➔ “Guide to the Select Photo Screen (Single View)” on page 82
- ➔ “Guide to the Preview Screen” on page 83
- ➔ “Guide to the Edit Photo Screen” on page 83
- ➔ “Menu Options for Editing Photos” on page 89

## Printing a Schedule

You can easily print a Monthly, Weekly, or Daily schedule.



- Load paper in the printer.
- Select **Various prints** on the control panel.  
To select an item, move the focus to the item using the     buttons, and then press the OK button.
- Select **Schedule**.
- Select the type of schedule.
- Make the paper settings, and then press the  button.
- When you select **Monthly** or **Daily**, set the date, and then select **Done**.
- Enter the number of copies, and then press the  button.

### Related Information

- ➔ “Loading Paper in the Paper Cassette 2” on page 66
- ➔ “List of Paper Types” on page 60
- ➔ “Menu Options for Paper and Print Settings” on page 88
- ➔ “Guide to the Preview Screen” on page 83

## Printing

### Printing Lined Paper

You can print some types of lined paper, graph paper, or music paper and create your own, original notebook or loose-leaf.



1. Load paper in the printer.
2. Select **Various prints** on the control panel.

To select an item, move the focus to the item using the ▲ ▼ ◀ ▶ buttons, and then press the OK button.

3. Select **Ruled Paper**.
4. Select the type of ruled line.
5. Make the paper settings.
6. Press the ▶ button.
7. Enter the number of copies, and then press the ◊ button.

#### Related Information

- ➔ [“Loading Paper in the Paper Cassette 2” on page 66](#)
- ➔ [“List of Paper Types” on page 60](#)
- ➔ [“Menu Options for Paper and Print Settings” on page 88](#)
- ➔ [“Guide to the Preview Screen” on page 83](#)

### Printing Original Writing Paper

You can easily print original writing paper with a photo from a memory device set as the background. The photo is printed lightly so that it can be easily written on.



## Printing

1. Load paper in the printer.
2. Insert a memory device into the SD card slot or the external interface USB port of the printer.
3. Select **Various prints** on the control panel.  
To select an item, move the focus to the item using the ▲ ▼ ◀ ▶ buttons, and then press the OK button.

4. Select **Writing Papers**.
5. Select the type of writing paper.
6. Select the type of background.
7. Use one of the following according to the background type you selected in step 6.

Photo

When a message telling you that loading photos is complete is displayed, select **Dismiss**. Select one photo on the select photo screen, select **Print Settings** to make the paper settings, and then press the ► button.

Press the  button if you want to print in landscape orientation.

Color

Select the background color, make the paper settings, and then press the ► button.

No Background

Make the paper settings, and then press the ► button. This is not available when **Without Rule** is selected as the type of writing paper.

8. Enter the number of copies, and then press the ◊ button.

### Related Information

- ➔ [“Loading Paper in the Paper Cassette 2” on page 66](#)
- ➔ [“List of Paper Types” on page 60](#)
- ➔ [“Inserting a Memory Card” on page 76](#)
- ➔ [“Menu Options for Paper and Print Settings” on page 88](#)
- ➔ [“Guide to the Select Photo Screen \(Single View\)” on page 82](#)
- ➔ [“Guide to the Preview Screen” on page 83](#)
- ➔ [“Guide to the Edit Photo Screen” on page 83](#)
- ➔ [“Menu Options for Editing Photos” on page 89](#)

## Printing an Original Message Card

You can easily print original message cards using a photo on your memory device.



## Printing

1. Load paper in the printer.
2. Insert a memory device into the SD card slot or the external interface USB port of the printer.
3. Select **Various prints** on the control panel.  
To select an item, move the focus to the item using the ▲ ▼ ◀ ▶ buttons, and then press the OK button.
4. Select **Message Card**.
5. Select **Image Position**, **Line Type**, and **Line Color**, and then select **Done**.
6. When a message telling you that loading photos is complete is displayed, press the OK button.
7. Select the photo you want to print, and then select **Print Settings**.
8. Make print settings.
9. Press the ▶ button.
10. Press the  button to edit the photo as necessary.
11. Enter the number of copies, and then press the ◊ button.

### Related Information

- ➔ [“Loading Paper in the Paper Cassette 1” on page 62](#)
- ➔ [“Loading Paper in the Paper Cassette 2” on page 66](#)
- ➔ [“List of Paper Types” on page 60](#)
- ➔ [“Inserting a Memory Card” on page 76](#)
- ➔ [“Menu Options for Printing Original Message Cards” on page 100](#)
- ➔ [“Menu Options for Paper and Print Settings” on page 88](#)
- ➔ [“Guide to the Preview Screen” on page 83](#)
- ➔ [“Guide to the Edit Photo Screen” on page 83](#)
- ➔ [“Menu Options for Editing Photos” on page 89](#)

## Menu Options for Printing Original Message Cards

### Image Position:

Select where you want to place the image on the message card.

### Line Type:

Select the type of ruled line to print on the message card.

### Line Color:

Select the color of the ruled line to print on the message card.

## Printing

### Printing a Coloring Book

You can print pictures by extracting only the outline of photos or illustrations. This allows you to create unique coloring books.



**Note:**

*Unless they are being used for personal use (at home or other restricted areas), you need permission from the copyright holder when using copyright protected originals to create a coloring book.*

1. Load paper in the printer.
2. If you want to use a photo on a memory device, insert the device into the SD card slot or the external interface USB port of the printer.
3. Select **Various prints** on the control panel.

To select an item, move the focus to the item using the ▲ ▼ ◀ ▶ buttons, and then press the OK button.

4. Select **Coloring Book**.
5. Do one of the following.
  - When selecting **Scan an original**: Make the print settings, and then press the ► button. Place the original on the scanner glass, and then press the OK button.
  - When selecting **Choose from the memory card**: Select a photo, select **Print Settings**, and then make the print settings. Press the ► button.
6. Press the ◊ button.

#### Related Information

- ➔ [“Loading Paper in the Paper Cassette 2” on page 66](#)
- ➔ [“Menu Options for Selecting Photos” on page 87](#)
- ➔ [“Menu Options for Paper and Print Settings” on page 88](#)

## Printing from a Computer

### Printing Basics - Windows

**Note:**

- See the online help for explanations of the setting items. Right-click an item, and then click **Help**.
- Operations differ depending on the application. See the application's help for details.

1. Load paper in the printer.

## Printing

- Open the file you want to print.
- Select **Print** or **Print Setup** from the **File** menu.
- Select your printer.
- Select **Preferences** or **Properties** to access the printer driver window.

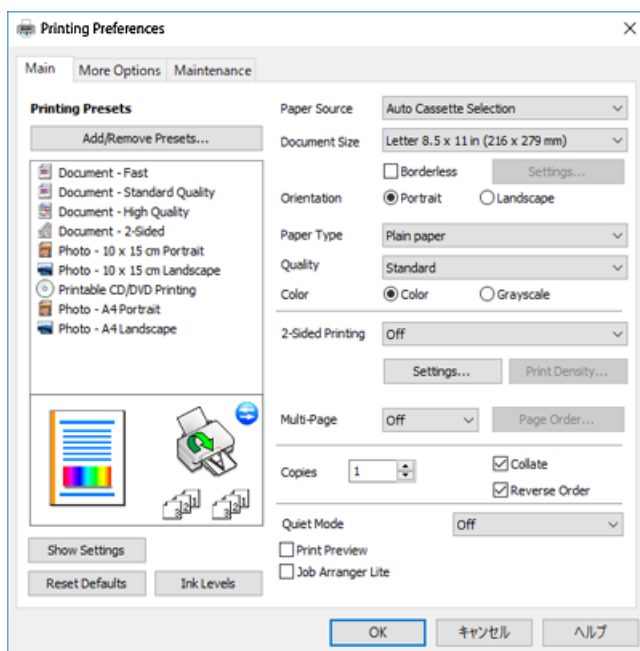

- Make the following settings.
  - Paper Source: Select the paper source in which you loaded the paper.
  - Document Size: Select the paper size you loaded in the printer.
  - Borderless: Select to print with no margins around the image.  
In borderless printing, the print data is enlarged slightly more than the paper size so that no margins are printed around the edges of the paper. Click **Settings** to select the amount of enlargement.
  - Orientation: Select the orientation you set in the application.
  - Paper Type: Select the type of paper you loaded.
  - Quality: Select the print quality.  
Selecting **High** provides higher quality printing, but the printing speed may be slower.
  - Color: Select **Grayscale** when you want to print in black or shades of gray.

**Note:**

When printing on envelopes, select **Landscape** as the **Orientation** setting.

- Click **OK** to close the printer driver window.
- Click **Print**.

### Related Information

➔ [“Available Paper and Capacities” on page 58](#)

## Printing

- ➔ “Loading Paper in the Paper Cassette 1” on page 62
- ➔ “Loading Paper in the Paper Cassette 2” on page 66
- ➔ “Guide to Windows Printer Driver” on page 189
- ➔ “List of Paper Types” on page 60

## Printing Basics - Mac OS

### Note:

Explanations in the section use *TextEdit* as an example. Operations and screens differ depending on the application. See the application's help for details.

1. Load paper in the printer.
2. Open the file you want to print.
3. Select **Print** from the **File** menu or another command to access the print dialog.

If necessary, click **Show Details** or ▼ to expand the print window.

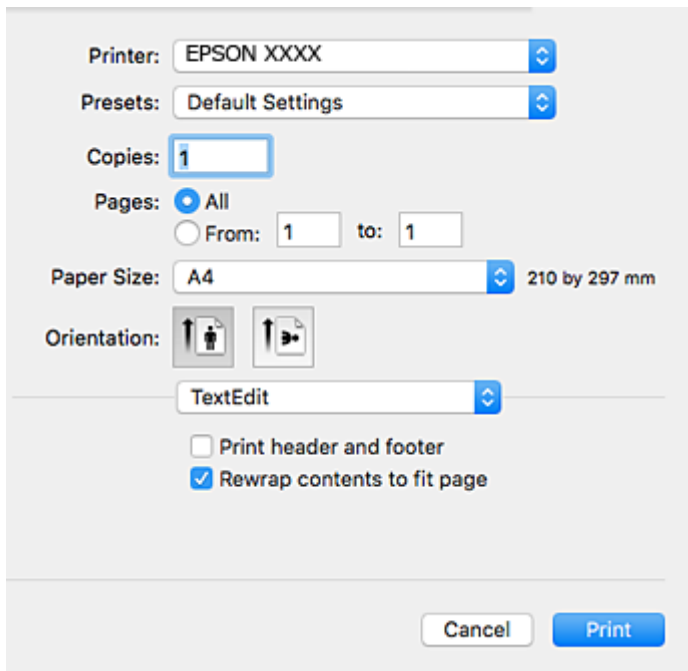

4. Make the following settings.
  - Printer: Select your printer.
  - Presets: Select when you want to use the registered settings.
  - Paper Size: Select the paper size you loaded in the printer.  
When printing with no margins, select a "borderless" paper size.
  - Orientation: Select the orientation you set in the application.

## Printing

**Note:**

- If the above setting menus are not displayed, close the print window, select **Page Setup** from the **File** menu, and then make settings.
- When printing on envelopes, select landscape orientation.

5. Select **Print Settings** from the pop-up menu.

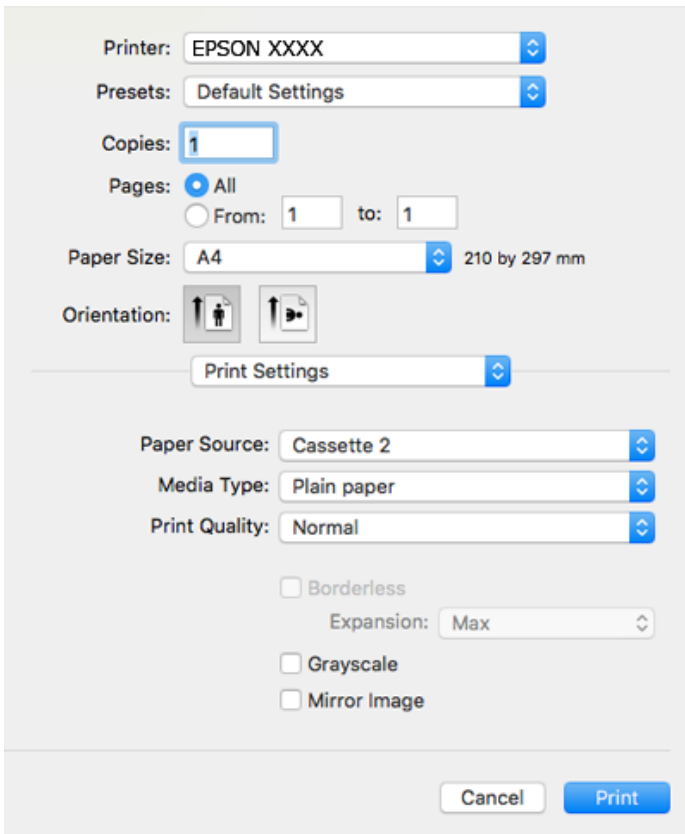

**Note:**

On OS X Mountain Lion or later, if the **Print Settings** menu is not displayed, the Epson printer driver has not been installed correctly.

Select **System Preferences** from the  menu > **Printers & Scanners** (or **Print & Scan**, **Print & Fax**), remove the printer, and then add the printer again. Access the following website, and then enter the product name. Go to **Support**, and then see **Tips**.

<http://epson.sn>

6. Make the following settings.

- Paper Source: Select the paper source in which you loaded the paper.

If you select **Auto Select**, the paper source is automatically selected according to the paper size and type selected on the printer's control panel.

If you enable the **Automatic Cassette Switching** function and select paper cassette 1 as the **Paper Source** setting, the printer automatically feeds paper from paper cassette 2 when paper runs out in paper cassette 1. Load the same paper (type and size) in paper cassette 1 and paper cassette 2.

To enable the **Automatic Cassette Switching** function, select **System Preferences** from the  menu > **Printers & Scanners** (or **Print & Scan**, **Print & Fax**), and then select the printer. Make settings on the screen displayed by clicking **Options & Supplies** > **Options** (or **Driver**).



## Printing

- Media Type: Select the type of paper you loaded.
- Print Quality: Select the print quality.  
Selecting Fine provides higher quality printing, but the printing speed may be slower.
- Expansion: Available when selecting a borderless paper size.  
In borderless printing, the print data is enlarged slightly more than the paper size so that no margins are printed around the edges of the paper. Select the amount of enlargement.
- Grayscale: Select to print in black or shades of gray.

7. Click **Print**.

### Related Information

- ➔ [“Available Paper and Capacities” on page 58](#)
- ➔ [“Loading Paper in the Paper Cassette 1” on page 62](#)
- ➔ [“Loading Paper in the Paper Cassette 2” on page 66](#)
- ➔ [“Guide to Mac OS Printer Driver” on page 192](#)
- ➔ [“List of Paper Types” on page 60](#)

## Printing on 2-Sides

You can use either of the following methods to print on both sides of the paper.

- Automatic 2-sided printing
- Manual 2-sided printing (for Windows only)

When the printer has finished printing the first side, flip the paper over to print on the other side.

You can also print a booklet that can be created by folding the printout. (For Windows only)

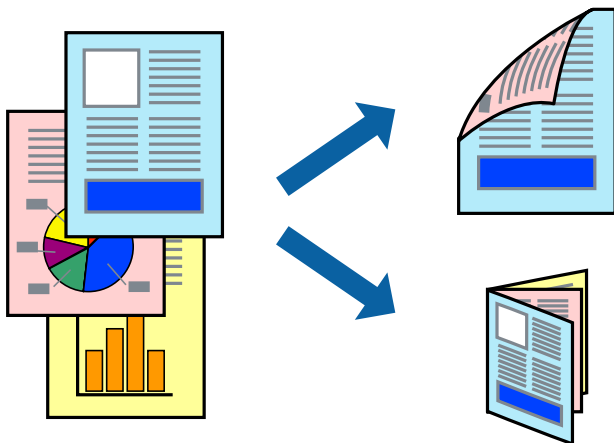

### Note:

- This feature is not available for borderless printing.
- If you do not use paper that is suitable for 2-sided printing, the print quality may decline and paper jams may occur.
- Depending on the paper and the data, ink may bleed through to the other side of the paper.

## Printing

### Related Information

- ➔ [“Available Paper and Capacities” on page 58](#)

## Printing on 2-Sides - Windows

### Note:

- Manual 2-sided printing is available when **EPSON Status Monitor 3** is enabled. If **EPSON Status Monitor 3** is disabled, access the printer driver, click **Extended Settings** on the **Maintenance** tab, and then select **Enable EPSON Status Monitor 3**.*

- Manual 2-sided printing may not be available when the printer is accessed over a network or is used as a shared printer.*

1. Load paper in the printer.
2. Open the file you want to print.
3. Access the printer driver window.
4. Select **Auto (Long-edge binding)**, **Auto (Short-edge binding)**, **Manual (Long-edge binding)**, or **Manual (Short-edge binding)** from **2-Sided Printing** on the **Main** tab.
5. Click **Settings**, make the appropriate settings, and then click **OK**.

### Note:

*To print a folded booklet, select **Booklet**.*

6. Click **Print Density**, select the document type from **Select Document Type**, and then click **OK**.

The printer driver automatically sets the **Adjustments** options for that document type.

### Note:

- Printing may be slow depending on the combination of options selected for **Select Document Type** in the **Print Density Adjustment** window and for **Quality** on the **Main** tab.*

- For manual 2-sided printing, the **Print Density Adjustment** setting is not available.*

7. Set the other items on the **Main** and **More Options** tabs as necessary, and then click **OK**.

8. Click **Print**.

For manual 2-sided printing, when the first side has finished printing, a pop-up window is displayed on the computer. Follow the on-screen instructions.

### Related Information

- ➔ [“Loading Paper in the Paper Cassette 1” on page 62](#)
- ➔ [“Loading Paper in the Paper Cassette 2” on page 66](#)
- ➔ [“Printing Basics - Windows” on page 101](#)

## Printing on 2-Sides - Mac OS

1. Load paper in the printer.
2. Open the file you want to print.

## Printing

3. Access the print dialog.
4. Select **Two-sided Printing Settings** from the pop-up menu.
5. Select the bindings in **Two-sided Printing**.
6. Select the type of original in **Document Type**.

**Note:**

- Printing may be slow depending on the **Document Type** setting.*
- If you are printing high-density data such as photos or graphs, select **Text with Photo** or **Photo** as the **Document Type** setting. If scuffing occurs or the image bleeds through to the reverse side, adjust the print density and ink drying time by clicking the arrow mark next to **Adjustments**.*

7. Set the other items as necessary.
8. Click **Print**.

### Related Information

- ➔ [“Loading Paper in the Paper Cassette 1” on page 62](#)
- ➔ [“Loading Paper in the Paper Cassette 2” on page 66](#)
- ➔ [“Printing Basics - Mac OS” on page 103](#)

## Printing Several Pages on One Sheet

You can print two or four pages of data on a single sheet of paper.

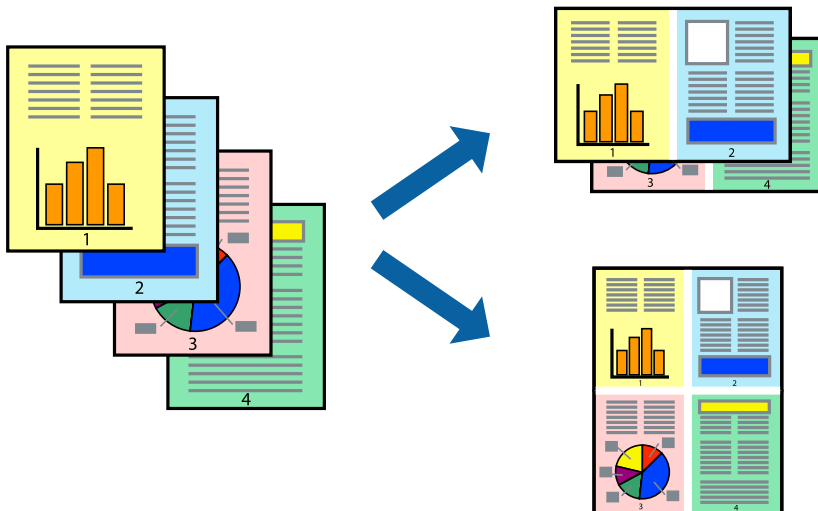

## Printing Several Pages on One Sheet - Windows

**Note:**

*This feature is not available for borderless printing.*

1. Load paper in the printer.
2. Open the file you want to print.

## Printing

3. Access the printer driver window.
4. Select **2-Up** or **4-Up** as the **Multi-Page** setting on the **Main** tab.
5. Click **Page Order**, make the appropriate settings, and then click **OK** to close the window.
6. Set the other items on the **Main** and **More Options** tabs as necessary, and then click **OK**.
7. Click **Print**.

### Related Information

- ➔ [“Loading Paper in the Paper Cassette 1” on page 62](#)
- ➔ [“Loading Paper in the Paper Cassette 2” on page 66](#)
- ➔ [“Printing Basics - Windows” on page 101](#)

## Printing Several Pages on One Sheet - Mac OS

1. Load paper in the printer.
2. Open the file you want to print.
3. Access the print dialog.
4. Select **Layout** from the pop-up menu.
5. Set the number of pages in **Pages per Sheet**, the **Layout Direction** (page order), and **Border**.
6. Set the other items as necessary.
7. Click **Print**.

### Related Information

- ➔ [“Loading Paper in the Paper Cassette 1” on page 62](#)
- ➔ [“Loading Paper in the Paper Cassette 2” on page 66](#)
- ➔ [“Printing Basics - Mac OS” on page 103](#)

## Printing to Fit the Paper Size

You can print to fit the paper size you loaded in the printer.

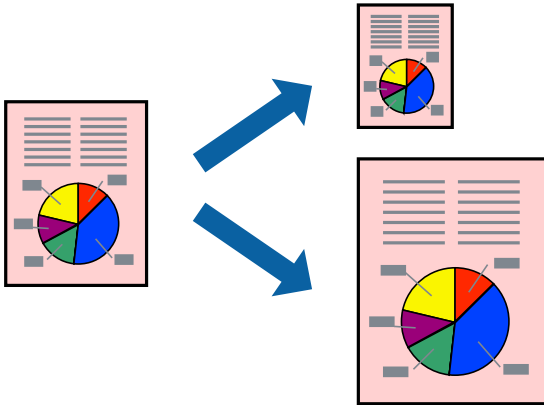

### Printing to Fit the Paper Size - Windows

**Note:**

*This feature is not available for borderless printing.*

1. Load paper in the printer.
2. Open the file you want to print.
3. Access the printer driver window.
4. Make the following settings on the **More Options** tab.
  - Document Size: Select the paper size you set in the application.
  - Output Paper: Select the paper size you loaded in the printer.

**Fit to Page** is selected automatically.

**Note:**

*If you want to print a reduced image at the center of the page, select **Center**.*

5. Set the other items on the **Main** and **More Options** tabs as necessary, and then click **OK**.
6. Click **Print**.

#### Related Information

- ➔ [“Loading Paper in the Paper Cassette 1” on page 62](#)
- ➔ [“Loading Paper in the Paper Cassette 2” on page 66](#)
- ➔ [“Printing Basics - Windows” on page 101](#)

### Printing to Fit the Paper Size - Mac OS

1. Load paper in the printer.

## Printing

2. Open the file you want to print.
3. Access the print dialog.
4. Select the size of the paper you set in the application as the **Paper Size** setting.
5. Select **Paper Handling** from the pop-up menu.
6. Select **Scale to fit paper size**.
7. Select the paper size you loaded in the printer as the **Destination Paper Size** setting.
8. Set the other items as necessary.
9. Click **Print**.

### Related Information

- ➔ [“Loading Paper in the Paper Cassette 1” on page 62](#)
- ➔ [“Loading Paper in the Paper Cassette 2” on page 66](#)
- ➔ [“Printing Basics - Mac OS” on page 103](#)

## Printing Multiple Files Together (for Windows Only)

**Job Arranger Lite** allows you to combine several files created by different applications and print them as a single print job. You can specify the print settings for combined files, such as layout, print order, and orientation.

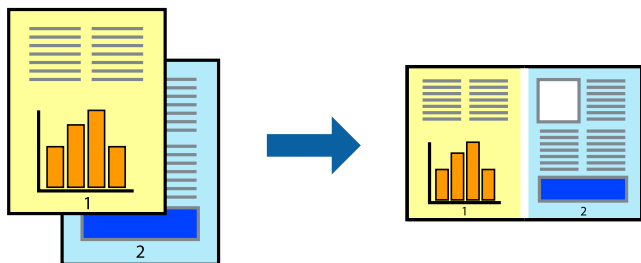

1. Load paper in the printer.
2. Open the file you want to print.
3. Access the printer driver window.
4. Select **Job Arranger Lite** on the **Main** tab.
5. Click **OK** to close the printer driver window.
6. Click **Print**.

The **Job Arranger Lite** window is displayed and the print job is added to the **Print Project**.

## Printing

- With the **Job Arranger Lite** window opened, open the file that you want to combine with the current file, and then repeat steps 3 to 6.

**Note:**

- ❑ If you close the **Job Arranger Lite** window, the unsaved **Print Project** is deleted. To print later, select **Save** from the **File** menu.
- ❑ To open a **Print Project** saved in **Job Arranger Lite**, click **Job Arranger Lite** on the printer driver's **Maintenance** tab. Next, select **Open** from the **File** menu to select the file. The extension of the saved files is ".ecl".

- Select the **Layout** and **Edit** menus in **Job Arranger Lite** to edit the **Print Project** as necessary. See the help of **Job Arranger Lite** for details.
- Select **Print** from the **File** menu.

### Related Information

- ➔ [“Loading Paper in the Paper Cassette 1” on page 62](#)
- ➔ [“Loading Paper in the Paper Cassette 2” on page 66](#)
- ➔ [“Printing Basics - Windows” on page 101](#)

## Printing One Image on Multiple Sheets to Create a Poster (for Windows Only)

This feature allows you to print one image on multiple sheets of paper. You can create a larger poster by taping them together.

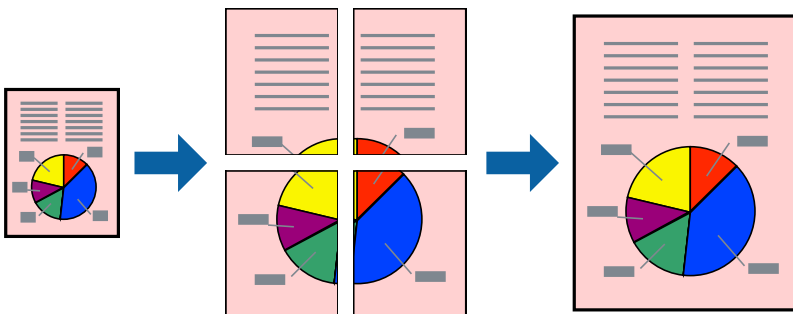

**Note:**

*This feature is not available for borderless printing.*

- Load paper in the printer.
- Open the file you want to print.
- Access the printer driver window.
- Select **2x1 Poster**, **2x2 Poster**, **3x3 Poster**, or **4x4 Poster** from **Multi-Page** on the **Main** tab.
- Click **Settings**, make the appropriate settings, and then click **OK**.

**Note:**

***Print Cutting Guides** allows you to print a cutting guide.*

- Set the other items on the **Main** and **More Options** tabs as necessary, and then click **OK**.

## Printing

7. Click **Print**.

### Related Information

- ➔ “Loading Paper in the Paper Cassette 1” on page 62
- ➔ “Loading Paper in the Paper Cassette 2” on page 66
- ➔ “Loading Paper in the Paper Cassette 1” on page 62
- ➔ “Loading Paper in the Paper Cassette 2” on page 66
- ➔ “Printing Basics - Windows” on page 101

### Making Posters Using Overlapping Alignment Marks

Here is an example of how to make a poster when **2x2 Poster** is selected, and **Overlapping Alignment Marks** is selected in **Print Cutting Guides**.

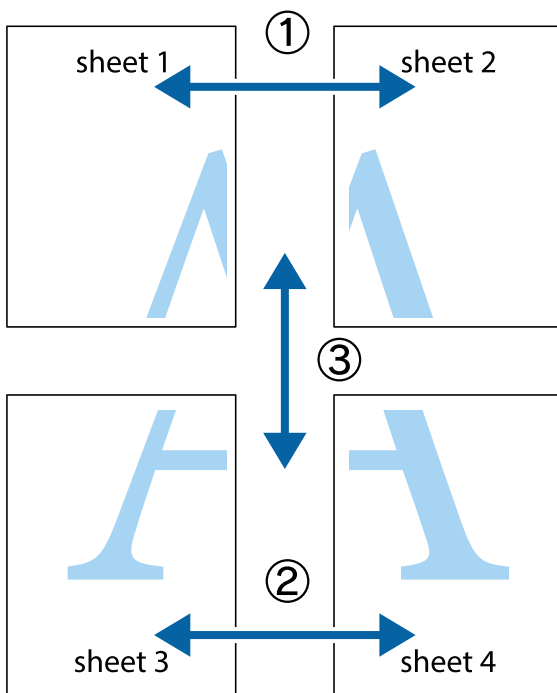



**Printing**

1. Prepare Sheet 1 and Sheet 2. Cut off the margins of Sheet 1 along the vertical blue line through the center of the top and bottom cross marks.

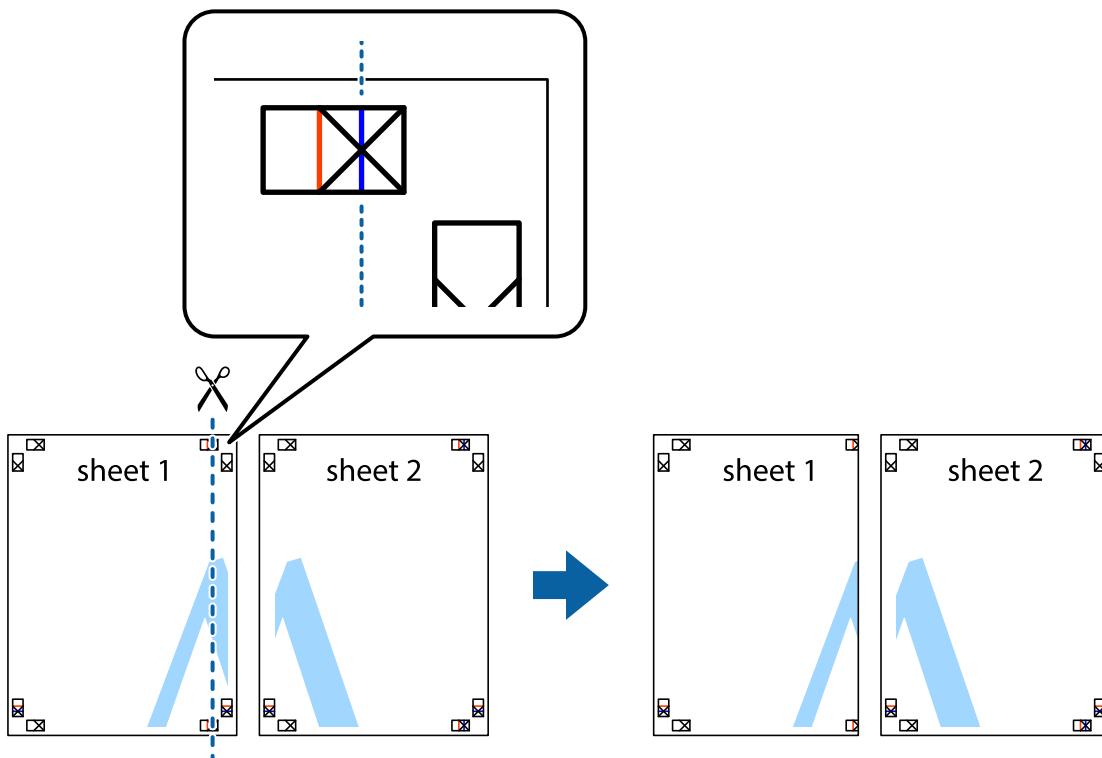

2. Place the edge of Sheet 1 on top of Sheet 2 and align the cross marks, then temporarily tape the two sheets together from the back.

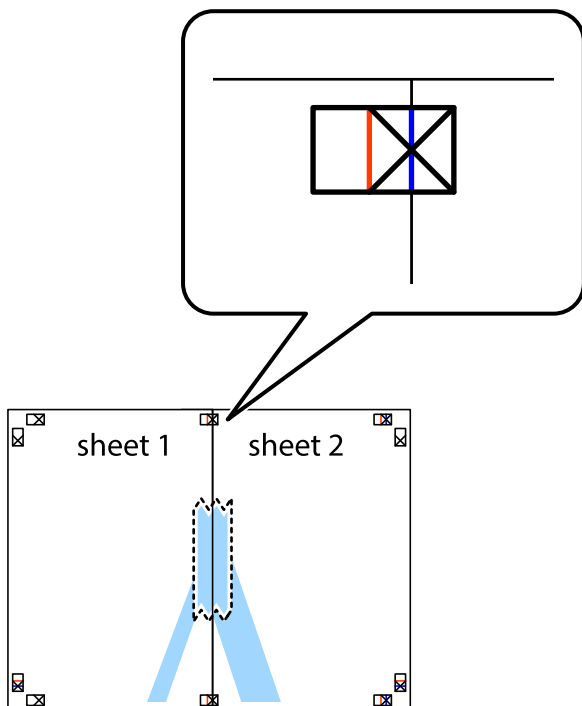

### Printing

- Cut the taped sheets in two along the vertical red line through the alignment markers (this time, the line to the left of the cross marks).

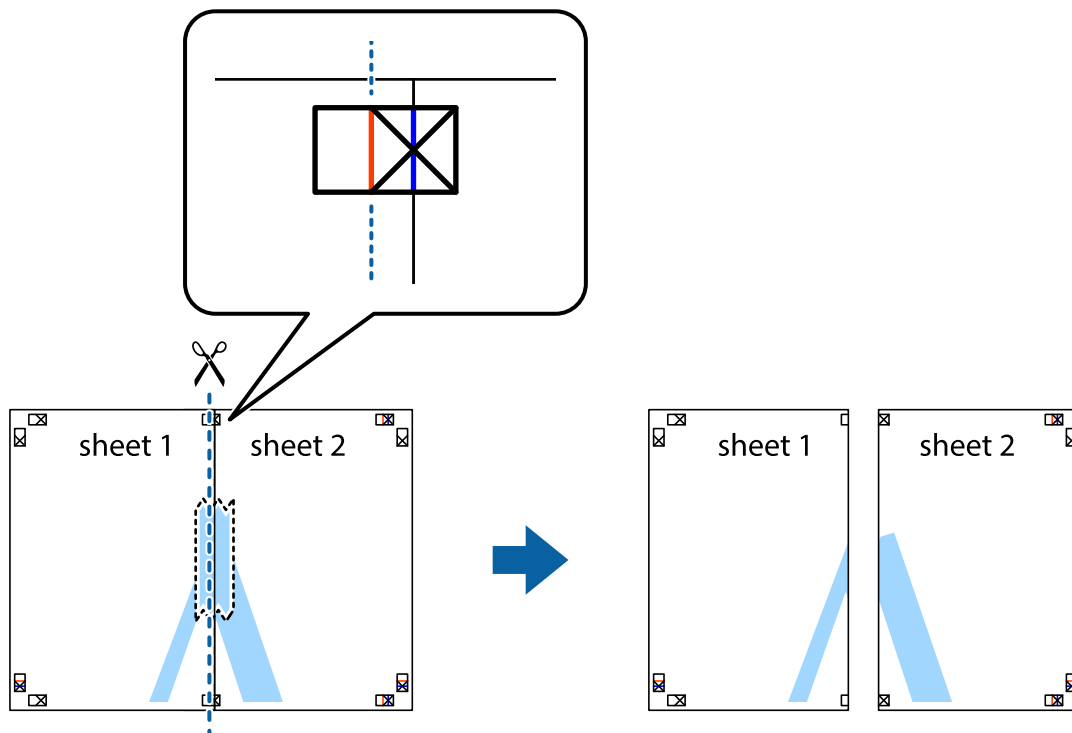

- Tape the sheets together from the back.

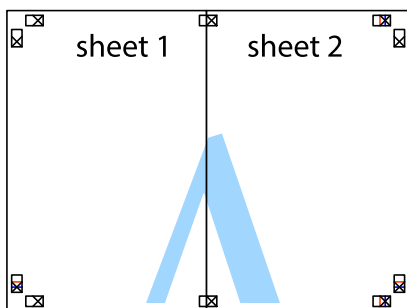

- Repeat steps 1 to 4 to tape Sheet 3 and Sheet 4 together.

### Printing

6. Cut off the margins of Sheet 1 and Sheet 2 along the horizontal blue line through the center of the left and right side cross marks.

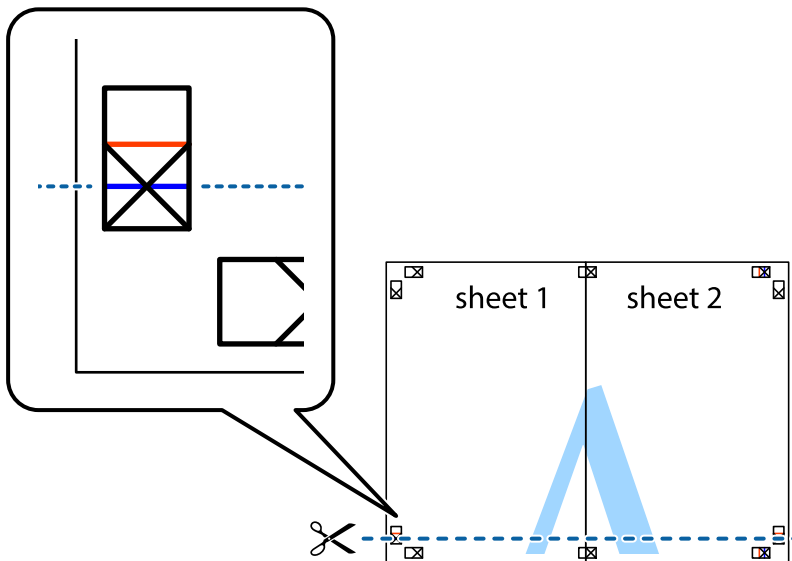

7. Place the edge of Sheet 1 and Sheet 2 on top of Sheet 3 and Sheet 4 and align the cross marks, and then temporarily tape them together from the back.

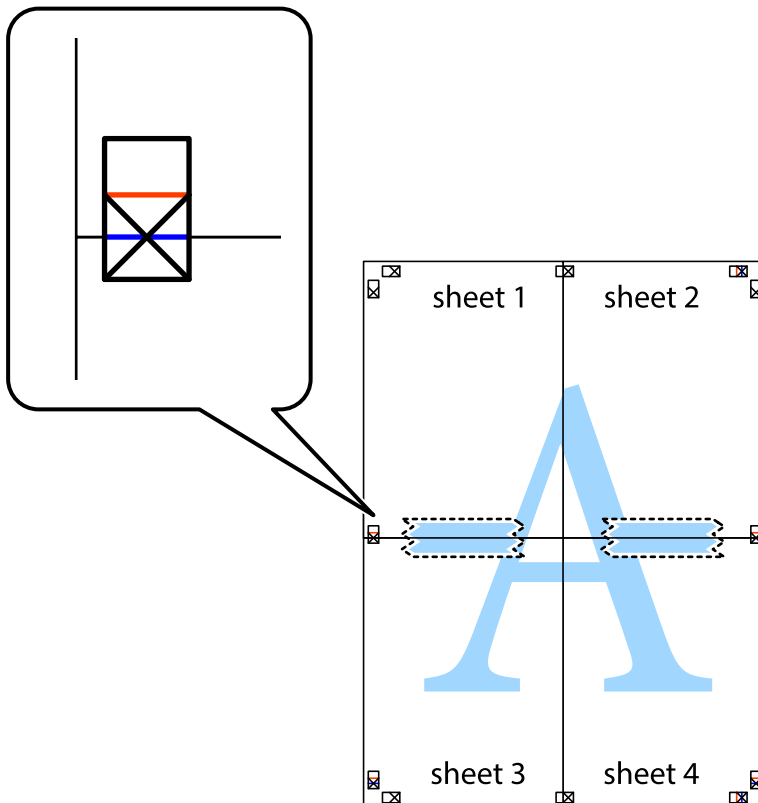

### Printing

- Cut the taped sheets in two along the horizontal red line through the alignment markers (this time, the line above the cross marks).



- Tape the sheets together from the back.

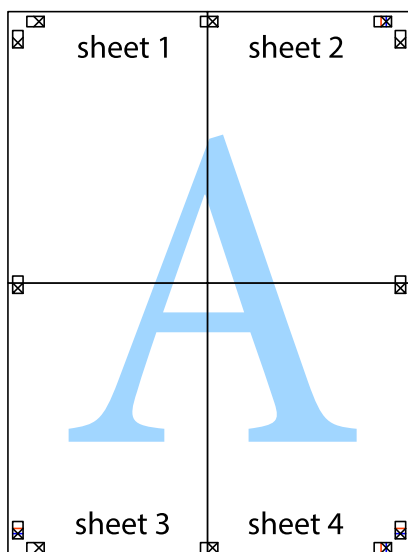

## Printing

10. Cut off the remaining margins along the outer guide.

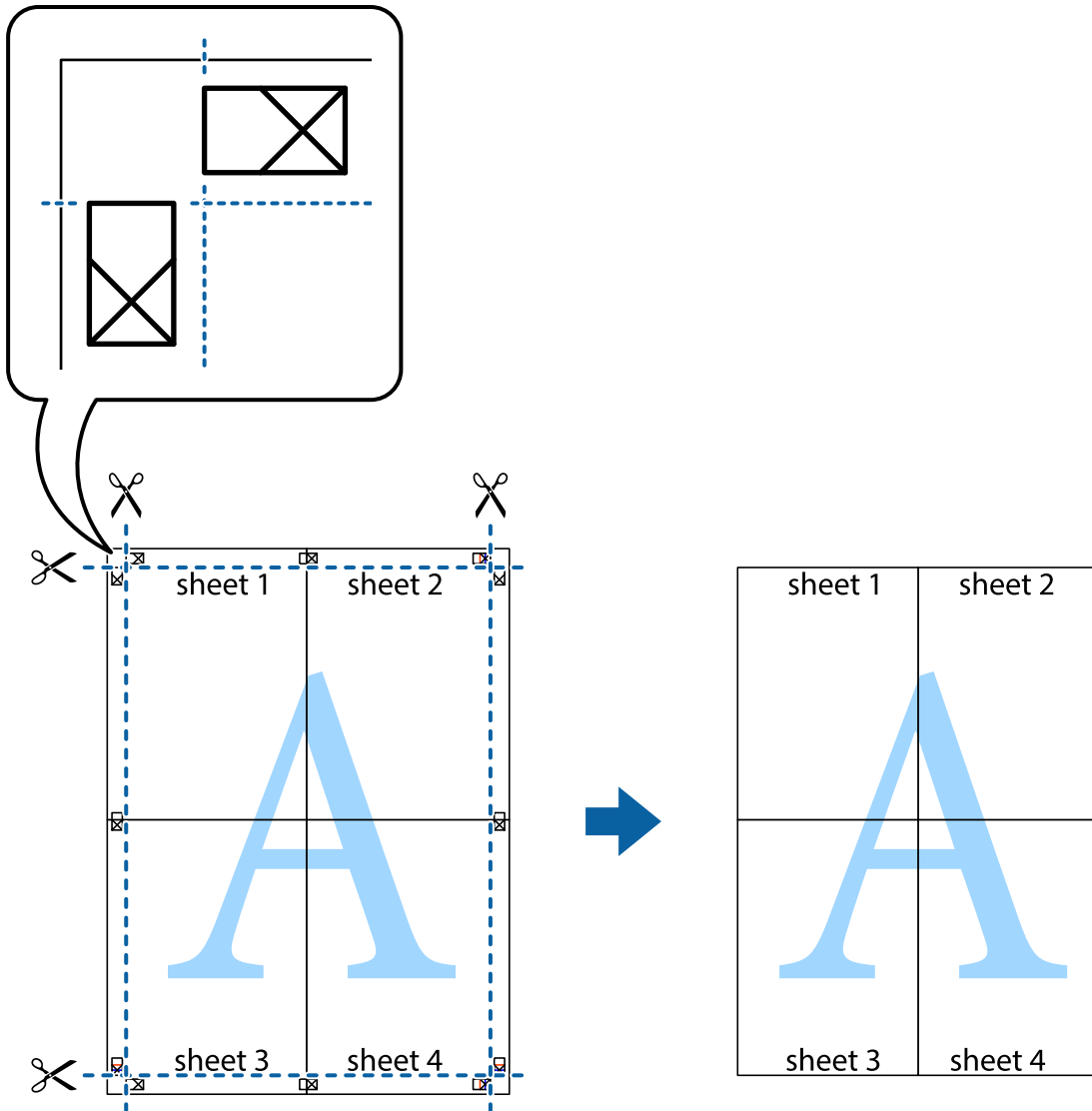

## Printing Using Advanced Features

This section introduces a variety of additional layout and printing features available on the printer driver.

### Related Information

- ➔ [“Windows Printer Driver” on page 188](#)
- ➔ [“Mac OS Printer Driver” on page 191](#)

## Adding a Printing Preset to Print Easily

If you create your own preset of frequently used print settings on the printer driver, you can print easily by selecting the preset from the list.

## Printing

### Windows

To add your own preset, set items such as the **Document Size** and **Paper Type** on the **Main** or **More Options** tab, and then click **Add/Remove Presets** in **Printing Presets**.

**Note:**

To delete an added preset, click **Add/Remove Presets**, select the preset name you want to delete from the list, and then delete it.

### Mac OS

Access the print dialog. To add your own preset, set items such as the **Paper Size** and **Media Type**, and then save the current settings as the preset in the **Presets** setting.

**Note:**

To delete an added preset, click **Presets > Show Presets**, select the preset name you want to delete from the list, and then delete it.

## Printing a Reduced or Enlarged Document

You can reduce or enlarge the size of a document by a specific percentage.

### Windows

**Note:**

This feature is not available for borderless printing.

Set the **Document Size** on the **More Options** tab. Select **Reduce/Enlarge Document**, **Zoom to**, and then enter a percentage.

### Mac OS

**Note:**

Operations differ depending on the application. See the application's help for details.

Select **Page Setup** (or **Print**) from the **File** menu. Select the printer from **Format For**, select the paper size, and then enter a percentage in **Scale**. Close the window, and then print following the basic printing instructions.

## Adjusting the Print Color

You can adjust the colors used in the print job.

**PhotoEnhance** produces sharper images and more vivid colors by automatically adjusting the contrast, saturation, and brightness of the original image data.

**Note:**

- These adjustments are not applied to the original data.
- PhotoEnhance** adjusts the color by analyzing the location of the subject. Therefore, if you have changed the location of the subject by reducing, enlarging, cropping, or rotating the image, the color may change unexpectedly. Selecting the borderless setting also changes the location of the subject resulting in changes in color. If the image is out of focus, the tone may be unnatural. If the color is changed or becomes unnatural, print in a mode other than **PhotoEnhance**.

### Windows

Select the method of color correction from **Color Correction** on the **More Options** tab.

## Printing

If you select **Automatic**, the colors are automatically adjusted to match the paper type and print quality settings. If you select **Custom** and click **Advanced**, you can make your own settings.

### Mac OS

Access the print dialog. Select **Color Matching** from the pop-up menu, and then select **EPSON Color Controls**. Select **Color Options** from the pop-up menu, and then select one of the available options. Click the arrow next to **Advanced Settings** and make the appropriate settings.

### Printing a Watermark (for Windows Only)

You can print a watermark such as "Confidential" on your printouts. You can also add your own watermark.

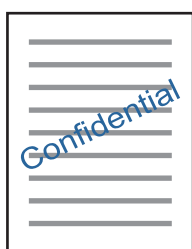

**Note:**

*This feature is not available with borderless printing.*

Click **Watermark Features** on the **More Options** tab, and then select a watermark. Click **Settings** to change details such as the density and position of the watermark.

### Printing a Header and Footer (for Windows Only)

You can print information such as a user name and printing date as headers or footers.

Click **Watermark Features** in the **More Options** tab, and then select **Header/Footer**. Click **Settings** and select necessary items from the drop-down list.

## Printing Photos Using Epson Easy Photo Print

Epson Easy Photo Print lets you lay out and print photos easily on various types of paper. See the application's help for details.

**Note:**

- By printing on genuine Epson photo paper, the ink quality is maximized and the printouts are vivid and clear.*
- To perform borderless printing using a commercially available application, make the following settings.*
  - Create image data to fit the paper size. If a margin setting is available in the application you are using, set the margin to 0 mm.
  - Enable the borderless printing setting in the printer driver.

### Related Information

- ➔ [“Application for Laying Out Photos \(Epson Easy Photo Print\)” on page 196](#)
- ➔ [“Installing Applications” on page 198](#)

## Printing

### Printing a CD/DVD Label with Epson Print CD

Epson Print CD lets you easily create and print an original design CD/DVD label. You can also create and print a CD/DVD jacket.

You can set the print range for the CD/DVD to a minimum of 18 mm for the inner diameter, and a maximum of 120 mm for the outer diameter. Depending on the settings, the CD/DVD or tray may be smeared. Set within the print range for the CD/DVD you want to print.

See the application's help for details.

**Note:**

*When printing a CD/DVD label using a commercially available application, make the following settings.*

- For Windows, A4 is automatically selected as the **Document Size** setting when you select **CD/DVD Tray** as the **Paper Source** setting. Select **Portrait** as the **Orientation** setting, and **CD/DVD** as the **Paper Type** setting.
- For Mac OS, select **A4 (CD/DVD)** as the **Paper Size** setting. Select portrait as the printing direction, and then select **CD/DVD** as the **Media Type** on the **Print Settings** menu.
- On some applications, you may need to specify the tray type. Select **Epson Tray Type 2**. The setting name may vary slightly depending on the application.

#### Related Information

- ➔ [“Application for Printing Text or Images on a Disc \(Epson Print CD\)” on page 196](#)
- ➔ [“Installing Applications” on page 198](#)

---

## Printing from Smart Devices

### Using Epson iPrint

Epson iPrint is an application that allows you to print photos, documents, and web pages from a smart device such as a smartphone or tablet. You can use local print, printing from a smart device that is connected to the same wireless network as your printer, or remote print, printing from a remote location over the Internet. To use remote print, register your printer in the Epson Connect service.

If you start Epson iPrint when the printer is not connected to the network, a message is displayed instructing you to connect to the printer. Follow the instructions to complete the connection. See the URL below for the operating conditions.

<http://epson.sn>



#### Related Information

- ➔ [“Epson Connect Service” on page 186](#)



## Printing

### Installing Epson iPrint

You can install Epson iPrint on your smart device from the following URL or QR code.

<http://ipr.to/a>



### Printing Using Epson iPrint

Start Epson iPrint from your smart device and select the item you want to use from the home screen.

The following screens are subject to change without notice. The contents may vary depending on the product.

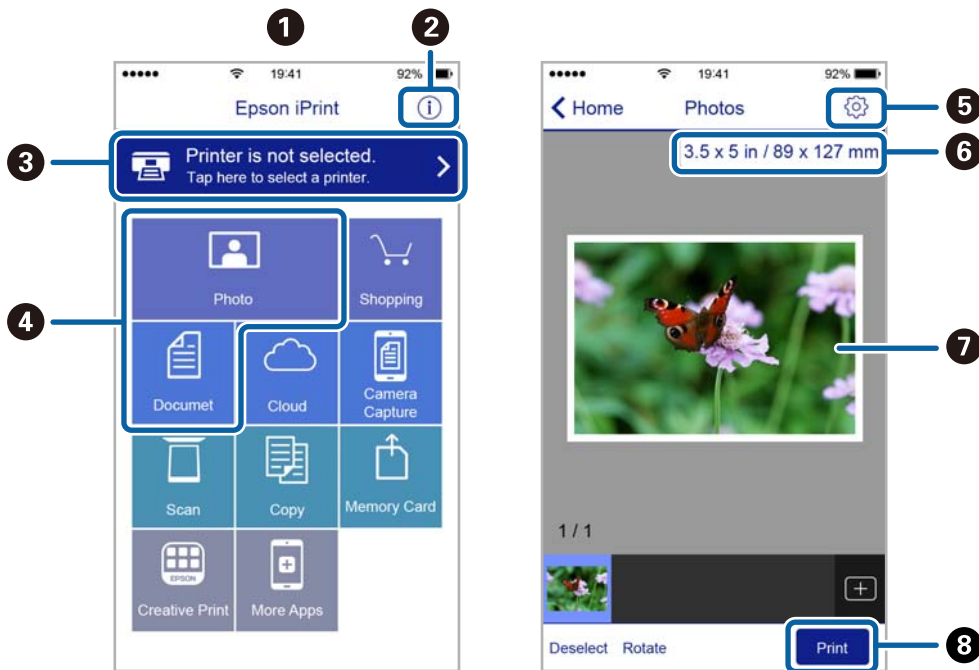

1	Home screen displayed when the application is started.
2	Displays information on how to setup the printer and a FAQ.
3	Displays the screen where you can select the printer and make printer settings. Once you have selected the printer, you do not need to select it again from the next time.
4	Select what you want to print such as photos and documents.
5	Displays the screen to make print settings such as paper size and paper type.
6	Displays the paper size. When this is displayed as a button, tap it to display the paper settings currently set on the printer.
7	Displays photos and documents you selected.

## Printing

8	Starts printing.
---	------------------

**Note:**

To print from the document menu using iPhone, iPad, and iPod touch running iOS, start Epson iPrint after transferring the document you want to print using the file sharing function in iTunes.

## Using Epson Print Enabler

You can wirelessly print your documents, emails, photos, and web pages right from your Android phone or tablet (Android v4.4 or later). With a few taps, your Android device will discover an Epson printer that is connected to the same wireless network.

1. Load paper in the printer.
2. Set up your printer for wireless printing.
3. On your Android device, install the Epson Print Enabler plug-in from Google Play.
4. Connect your Android device to the same wireless network as your printer.
5. Go to **Settings** on your Android device, select **Printing**, and then enable Epson Print Enabler.
6. From an Android application such as Chrome, tap the menu icon and print whatever is on the screen.

**Note:**

If you do not see your printer, tap **All Printers** and select your printer.

### Related Information

- ➔ [“Loading Paper in the Paper Cassette 1” on page 62](#)
- ➔ [“Loading Paper in the Paper Cassette 2” on page 66](#)
- ➔ [“Connecting to a Smart Device” on page 28](#)

## Using AirPrint

AirPrint enables instant wireless printing from iPhone, iPad, and iPod touch with the latest version of iOS, and Mac with the latest version of OS X or macOS.



## Printing

**Note:**

If you disabled paper configuration messages on your product control panel, you cannot use AirPrint. See the link below to enable the messages, if necessary.

1. Load paper in your product.
2. Set up your product for wireless printing. See the link below.  
<http://epson.sn>
3. Connect your Apple device to the same wireless network that your product is using.
4. Print from your device to your product.

**Note:**

For details, see the AirPrint page on the Apple website.

### Related Information

- ➔ “Cannot Print from an iPhone or iPad” on page 220
- ➔ “Menu Options for Printer Settings” on page 181
- ➔ “Loading Paper in the Paper Cassette 1” on page 62
- ➔ “Loading Paper in the Paper Cassette 2” on page 66

---

## Printing from a Digital Camera

**Note:**

- You can print photos directly from a PictBridge-compatible digital camera. For more details on making operations on your camera, see the documentation provided with your camera.
- Usually digital camera settings are given priority; however, in the following situations, the printer settings are given priority.
  - When the camera's print setting is set to "use printer settings"
  - When the **Sepia** or **B&W** option is selected in the printer's print settings.
  - When combining the print settings of the camera and the printer produces settings that are not available on the printer.

## Printing from a Digital Camera Connected by USB Cable

You can print photos directly from a digital camera connected by USB cable.

1. Remove a memory device from the printer.
2. Load paper in the printer.
3. Select **Settings** > **Camera Print Settings** from the home screen.

To select an item, move the focus to the item using the ▲ ▼ ◀ ▶ buttons, and then press the OK button.

4. Select **Print Settings** or **Photo Adjustments** and change the settings if necessary.

## Printing

5. Turn on the digital camera, and then connect to the printer using a USB cable.

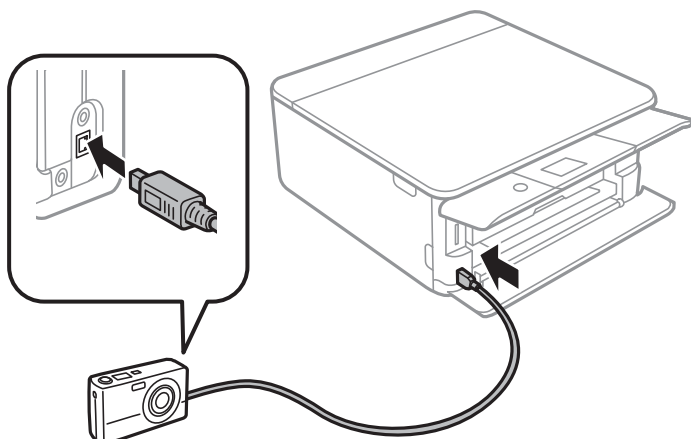

**Note:**

Use a USB cable that is shorter than two meters.

6. Select the photos you want to print from the digital camera, make settings such as the number of copies, and then start printing.

### Related Information

- ➔ [“Loading Paper in the Paper Cassette 1” on page 62](#)
- ➔ [“Loading Paper in the Paper Cassette 2” on page 66](#)
- ➔ [“Menu Options for Paper and Print Settings” on page 88](#)
- ➔ [“Menu Options for Editing Photos” on page 89](#)

## Printing from a Digital Camera Connected Wirelessly

You can wirelessly print photos from digital cameras that support the DPS over IP standard (from here on referred to as PictBridge (wireless LAN)).

1. Make sure the icon that indicates that the printer is connected to a wireless network is displayed on the home screen.
2. Load paper in the printer .
3. Select **Settings** > **Camera Print Settings** from the home screen.  
To select an item, move the focus to the item using the ▲ ▼ ◀ ▶ buttons, and then press the OK button.
4. Select **Print Settings** or **Photo Adjustments** and change the settings if necessary.
5. Connect the digital camera to the same network as the printer.
6. Display the list of available printers on the digital camera, and then select the printer you want to connect to.

**Note:**

- ❑ To check the printer's name, select the network status icon on the home screen.
- ❑ If your digital camera has a function that allows you to register printers, you can connect to the printer by selecting it from the next time.

## Printing

7. Select the photos you want to print from the digital camera, make settings such as the number of copies, and then start printing.
8. Disconnect the PictBridge (wireless LAN) connection to the printer from the digital camera.

**Important:**

*When using PictBridge (wireless LAN), you cannot use other printer functions or print from other devices. Disconnect immediately when you have finished printing.*

### Related Information

- ➔ [“Icons displayed in the LCD Screen” on page 19](#)
- ➔ [“Loading Paper in the Paper Cassette 1” on page 62](#)
- ➔ [“Loading Paper in the Paper Cassette 2” on page 66](#)
- ➔ [“Menu Options for Paper and Print Settings” on page 88](#)
- ➔ [“Menu Options for Editing Photos” on page 89](#)

---

## Canceling Printing

**Note:**

- In Windows, you cannot cancel a print job from the computer once it has been completely sent to the printer. In this case, cancel the print job by using the printer's control panel.*
- When printing several pages from Mac OS, you cannot cancel all of the jobs by using the control panel. In this case, cancel the print job from the computer.*
- If you have sent a print job from Mac OS X v10.6.8 through the network, you may not be able to cancel printing from the computer. In this case, cancel the print job by using the printer's control panel.*

### Canceling Printing - Control Panel

Press the  button on the printer's control panel to cancel the print job in progress.

### Canceling Printing - Windows

1. Access the printer driver window.
2. Select the **Maintenance** tab.
3. Click **Print Queue**.
4. Right-click on the job you want to cancel and then select **Cancel**.

### Related Information

- ➔ [“Windows Printer Driver” on page 188](#)

## Canceling Printing - Mac OS

1. Click the printer icon in the **Dock**.
2. Select the job you want to cancel.
3. Cancel the job.
  - OS X Mountain Lion or later  
Click  next to the progress meter.
  - Mac OS X v10.6.8 to v10.7.x  
Click **Delete**.

# Copying

## Copying Basics

This section explains the steps for copying from the **Copy** menu on the control panel.

1. Load paper in the printer.
2. Place the originals.
3. Select **Copy** on the home screen.

To select an item, move the focus to the item using the ▲ ▼ ◀ ▶ buttons, and then press the OK button.

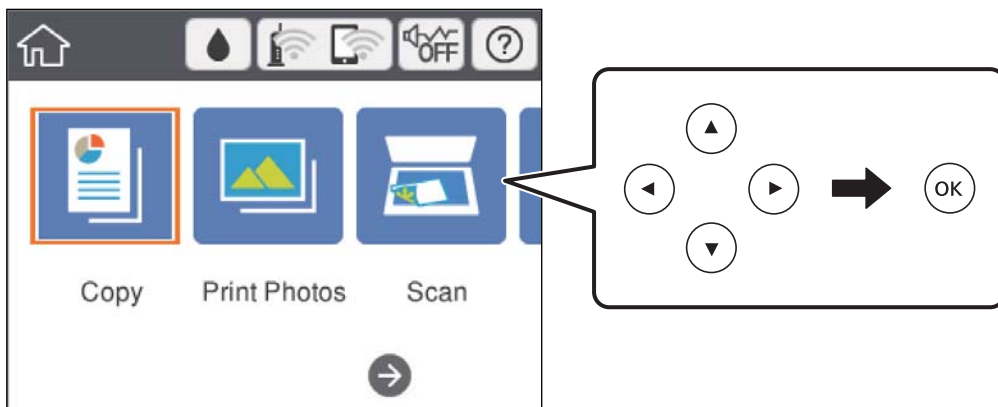

4. Make the settings on the **Copy** tab.
  - ❑ B&W/Color: Select color copy or monochrome copy.
  - ❑ (2-Sided Copying): When making 2-sided copies, select the item, select **1→2-Sided**, and then make settings for **Original Orientation** and **Binding Margin**. Select **Done** to confirm.
  - ❑ (Density): Select the item to make settings for copy density. Press the + button to increase the density, and press the - button to decrease the density. Select **Done** to confirm.
5. Select the **Advanced Settings** tab, and then change the settings as necessary.
6. Select the **Copy** tab, and then set the number of copies.
7. Press the button.

**Note:**

*The color, size, and border of the copied image are slightly different from the original.*

### Related Information

- ➔ [“Loading Paper in the Paper Cassette 1” on page 62](#)
- ➔ [“Loading Paper in the Paper Cassette 2” on page 66](#)
- ➔ [“Placing Originals on the Scanner Glass” on page 72](#)

➔ [“Menu Options for Copying” on page 133](#)

---

## Various Copying Methods

### Copying in Various Layout

You can copy easily by selecting a menu for your purpose such as copying both sides of an ID card onto one side of A4 size paper, or copying two facing pages of a book onto a single sheet of paper.

1. Load paper in the printer.
2. Select **Various prints** on the control panel.

To select an item, move the focus to the item using the ▲ ▼ ◀ ▶ buttons, and then press the OK button.

3. Select **Various copies**, and then select a copy menu.

ID Card

Scans both sides of an ID card and copies onto one side of A4 size paper.

Book Copy

Copies two A4 facing pages of a book and so on onto a single sheet of paper.

Borderless Copy

Copies without margins around the edges. The image is enlarged a little to remove margins from the edges of the paper.

4. Place the originals.

For **Book Copy**, place the first page of the originals following the instructions displayed on the screen, and then press the OK button.

5. Make the settings on the **Copy** tab.

Available items vary depending on the copy menu.

6. Make the settings for each item on the **Advanced Settings** tab as necessary.

7. Select the **Copy** tab, and then set the number of copies.

8. Press the ◊ button.

**Note:**

If you select **Preview**, you can check the scanned image.

9. For **ID Card** or **Book Copy**, follow the on-screen instructions to place the rest of the originals, and then select **Start Scanning**.

#### Related Information

- ➔ [“Loading Paper in the Paper Cassette 1” on page 62](#)
- ➔ [“Loading Paper in the Paper Cassette 2” on page 66](#)
- ➔ [“Placing Originals on the Scanner Glass” on page 72](#)



## Copying

- ➔ [“Placing an ID Card for Copying” on page 74](#)
- ➔ [“Menu Options for Copying” on page 133](#)

## Copying Photos

You can copy multiple photos at the same time. You can also restore the colors in faded photos.

The smallest size of original you can copy is 30×40 mm.

**Note:**

*White space around the photo may not be detected.*

1. Load paper in the printer.
2. Select **Various prints** on the home screen.  
To select an item, move the focus to the item using the ▲ ▼ ◀ ▶ buttons, and then press the OK button.
3. Select **Various copies > Copy/Restore Photos**.
4. Change the print settings as necessary, and then press the ▶ button.
5. Place the photos on the scanner glass, and then select **Start Scanning**.  
The photos are scanned and displayed on the screen.
6. Press the  button if necessary to make settings such as photo adjustments.  
**Note:**  
*If you want to print by enlarging part of a photo, select **Crop/Zoom**, and then make settings. Slide the print area frame using the ▲ ▼ ◀ ▶ buttons, and then change the frame size using the + or - button.*
7. Set the number of copies as necessary, and then press the ◊ button.

### Related Information

- ➔ [“Loading Paper in the Paper Cassette 1” on page 62](#)
- ➔ [“Loading Paper in the Paper Cassette 2” on page 66](#)
- ➔ [“Placing Photos for Copying” on page 73](#)
- ➔ [“Menu Options for Paper and Print Settings for Copying Photos” on page 129](#)
- ➔ [“Menu Options for Photo Adjustments for Copying Photos” on page 130](#)

## Menu Options for Paper and Print Settings for Copying Photos

### Restore Color

Restores the color of faded photos.

### Paper Size

Select the paper size you loaded.

## Copying

### Paper Type

Select the paper type you loaded.

### Paper Cassettes

Check the paper source that you want to use.

### Border Setting

Borderless

Copies without margins around the edges. The image is enlarged a little to remove margins from the edges of the paper. Select how much to enlarge in the Expansion setting.

With Border

Copies with margins around the edges.

### Clear All Settings:

Resets the copy settings to their defaults.

## Menu Options for Photo Adjustments for Copying Photos

### Photo Adjustments

Selecting **PhotoEnhance** produces sharper images and more vivid colors by automatically adjusting the contrast, saturation, and brightness of the original image data.

### Filter

Copies in monochrome.

### Crop/Zoom

Enlarges a part of the photo to be copied.

### Clear Edit.

Clear photo edit.

## Copying on a CD/DVD Label

You can copy a disc label or a square original such as a photo onto a CD/DVD label.



### **Important:**

- Before printing on the CD/DVD, see the CD/DVD handling precautions.
- Do not insert the CD/DVD tray while the printer is operating. This may damage the printer.
- Do not insert the CD/DVD tray until you are instructed to do so. Otherwise, an error occurs and the CD/DVD is ejected.

1. Select **Various prints** on the home screen.

To select an item, move the focus to the item using the ▲ ▼ ◀ ▶ buttons, and then press the OK button.

2. Select **Copy to CD/DVD > Copy to CD/DVD**.

## Copying

- Place the original following the instructions displayed on the screen, and then press the OK button.
- Specify the inner diameter and the outer diameter using the - or + button, and then select **Select Type**.  
You can also select within the frame of the inner diameter and outer diameter, and then enter the value using the on-screen keypad.

**Note:**

- ❑ You can set 114 to 120 mm as the outer diameter, and 18 to 46 mm as the inner diameter in 1 mm increments.
- ❑ The outer diameter and the inner diameter you set are restored to their defaults after printing the disc label. You need to set these diameters every time you print.

- Select **Print on CD/DVD**.

**Note:**

To make a test print, select **Test print on A4 paper**, and then load A4 plain paper in the paper cassette. You can check the printout image before printing on a CD/DVD label.

- When the message is displayed on the screen telling you to load a CD/DVD, select **How To**, and then follow the on-screen instructions to load a CD/DVD.

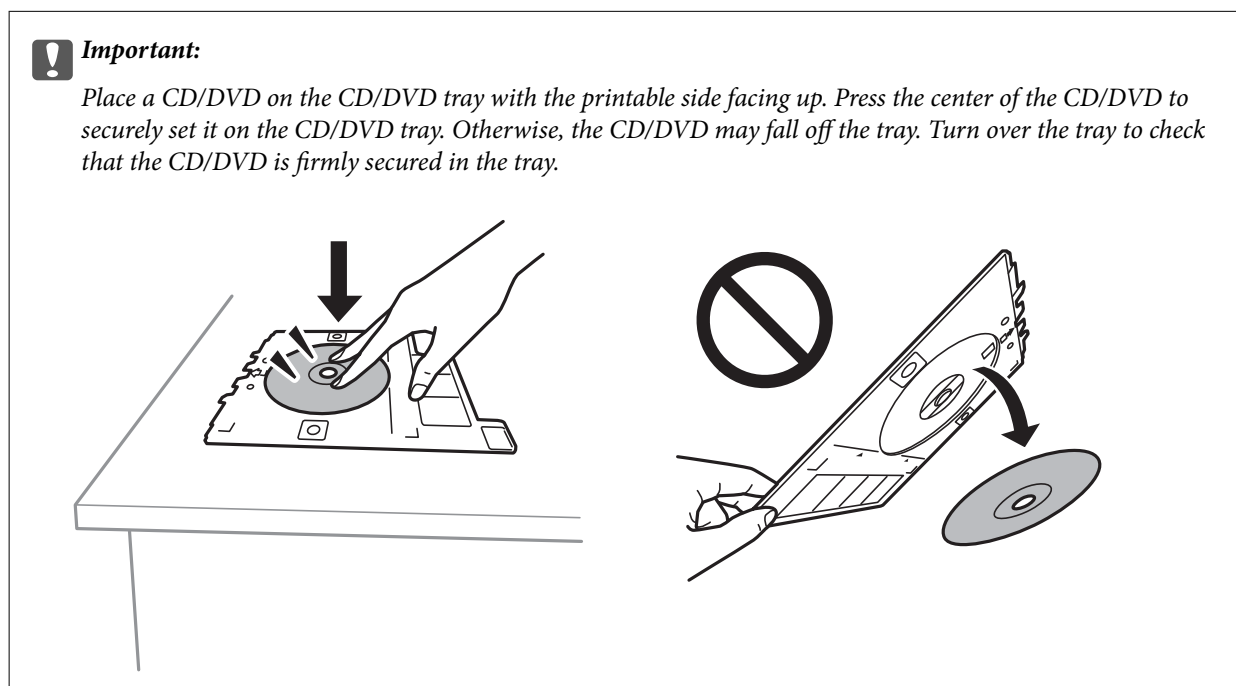

**Note:**

You may feel slight friction when inserting the tray into the printer. This is normal and you should continue to insert it horizontally.

- Select **Installed**.
- Select color copy or monochrome copy, and then change the copy density as necessary.

**Note:**

Select  to view the scanned image. You can adjust the printing position on the preview screen.

- Press the  button.

## Copying

10. When printing has finished, the CD/DVD tray is ejected. Remove the tray from the printer, and then follow the on-screen instructions to select **Done**.



### **Important:**

*After printing is finished, make sure you remove the CD/DVD tray. If you do not remove the tray and turn the printer on or off, or run head cleaning, the CD/DVD tray will strike the print head and may cause the printer to malfunction.*

11. Remove the CD/DVD and store the CD/DVD tray on the bottom of the paper cassette 2.

### Related Information

- ➔ [“Placing a CD/DVD for Copying Labels” on page 74](#)
- ➔ [“CD/DVD Handling Precautions” on page 78](#)
- ➔ [“Menu Options for Copy to CD/DVD” on page 132](#)

## Menu Options for Copy to CD/DVD

### Inner, Outer

Specify the print range. Up to 120 mm for the outer diameter, and a minimum of 18 mm for the inner diameter can be specified. Depending on the setting, the CD/DVD or CD/DVD tray may get dirty. Set the range to fit the printable area of your CD/DVD.

### Print on CD/DVD, Test print on A4 paper

Select whether to print on a CD/DVD or make a test print on A4 size plain paper. When you select **Test print on A4 paper**, you can check the print result before printing on a CD/DVD.



### (Print position adjustment)

Start scanning the original and displays the scanned image. You can adjust the printing position on the preview screen.

### Color

Copies the original in color.

### B&W

Copies the original in black and white (monochrome).

### Density

Increase the level of density by using + when the copying results are faint. Decrease the level of density by using - when ink smears.

### Original Type

Select the type of your original. Copies in optimal quality to match the type of original.

### Quality

Select the quality for copying. Selecting **Best** provides higher quality printing, but the printing speed may be slower.

## Copying

### Clear All Settings

Resets the copy settings to their defaults.

---

## Menu Options for Copying

Available items on the **Copy** tab and **Advanced Settings** tab vary depending on the menu you selected.

### Preview

Shows a scanned image to preview the copy results.

### B&W

Copies the original in black and white (monochrome).

### Color

Copies the original in color.



### (2-Sided Copying)

1→1-Sided

Copies one side of an original onto a single side of paper.

1→2-Sided

Copies two single-sided originals onto both sides of a single sheet of paper. Select the orientation of your original and the binding position of the paper.



### (Density)

Increase the level of density by using + when the copying results are faint. Decrease the level of density by using - when ink smears.

### Reduce/Enlarge

Enlarges or reduces the originals. Select the value and specify the magnification used to enlarge or reduce the original within a range of 25 to 400%.

Actual Size

Copies at 100 % magnification.

## Copying

### Auto Fit Page

Detects the scan area and automatically enlarges or reduces the original to fit to the paper size you selected. When there are white margins around the original, the white margins from the corner mark of the scanner glass are detected as the scan area, but the margins at the opposite side may be cropped.

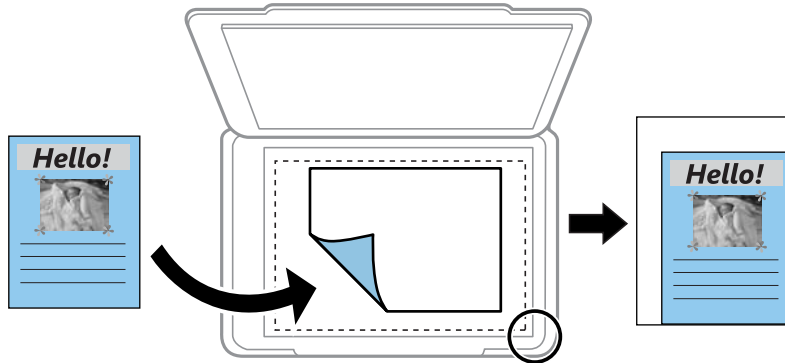

### 10x15cm→A4, A4→10x15cm, and so on

Automatically enlarges or reduces the original to fit to a specific paper size.

### Paper Size

Select the paper size you loaded.

### Paper Type

Select the paper type you loaded.

### Paper Cassettes

Select the paper source that you want to use.

### Multi-Page

#### Single Page

Copies a single-sided original onto a single sheet.

#### 2-up

Copies two single-sided originals onto a single sheet in 2-up layout. You can select the orientation and the size of your original. Check the image on the right side to select Original Orientation, and then select **Done** to confirm.

### Quality

Select the quality for copying. Selecting **Best** provides higher quality printing, but the printing speed may be slower.

### Remove Background

Detects the paper color (background color) of the original document, and removes or lightens the color. Depending on the darkness and vividness of the color, it may not be removed or lightened.

### Clear All Settings

Resets the copy settings to their defaults.

# Scanning

## Scanning Using the Control Panel

### Scanning to a Memory Device

You can save the scanned image to a memory device.

**Note:**

You cannot save multiple originals as one PDF file when scanning from the control panel. By using Epson Scan 2 and setting *Add or edit pages after scanning* on the **Document Mode**, you can scan additional originals after you scanned the original, and then save as one file.

1. Insert an external memory device into the printer.
2. Place the originals.
3. Select **Scan** on the home screen.

To select an item, move the focus to the item using the ▲▼◀▶ buttons, and then press the OK button.

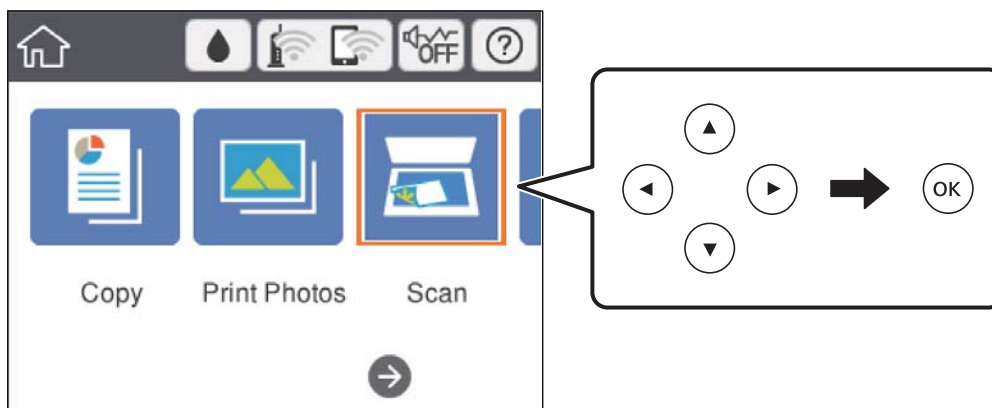

4. Select **Memory Device**.

If you attach multiple memory devices to the printer, select the memory device to which the scanned images are saved.

5. Set items on **Scan** tab, such as the save format.

- B&W/Color: Select whether to scan in color or in monochrome.
- JPEG/PDF: Select the format in which to save the scanned image.
-  (Quality): Select the item, and then set the **Original Type** and **Resolution**.

6. Select **Advanced Settings** tab, and then check settings, and change them if necessary.

## Scanning

7. Select **Scan** tab, and then press the  button.

**Note:**

- Scanned images are saved in the "001" to "999" folders in "EPSCAN" folder.
- The color, size, and border of the scanned image will not be exactly the same as the original.

### Related Information

- ➔ ["Inserting a Memory Card" on page 76](#)
- ➔ ["Placing Originals on the Scanner Glass" on page 72](#)

## Basic Menu Options for Scanning to a Memory Device

### B&W/Color:

Select whether to scan in color or in monochrome.

### JPEG/PDF:

Select the format in which to save the scanned image.



### (Quality) :

- Original Type:  
Select the type of your original.
- Resolution:  
Select the scanning resolution.

## Advanced Menu Options for Scanning to a Memory Device

### Scan Settings:

- Scan Size:  
Select the scan size. To crop the white space around the text or image when scanning, select **Auto Cropping**. To scan at the maximum area of the scanner glass, select **Max Area**.
- Original Orientation:  
Select the orientation of the original.

### Contrast:

Select the contrast of the scanned image.

### Select memory device:

Select the memory device to which you want to save the scanned image.

### Clear All Settings:

Resets the scan settings to their defaults.



## Scanning to a Computer

### **!** Important:

Before scanning, install *Epson Scan 2* and *Epson Event Manager* on your computer.

### Note:

You cannot save multiple originals as one PDF file when scanning from the control panel. By using *Epson Scan 2* and setting **Add or edit pages after scanning** on the **Document Mode**, you can scan additional originals after you scanned the original, and then save as one file.

1. Place the originals.
2. Select **Scan** on the home screen.

To select an item, move the focus to the item using the ▲▼◀▶ buttons, and then press the OK button.

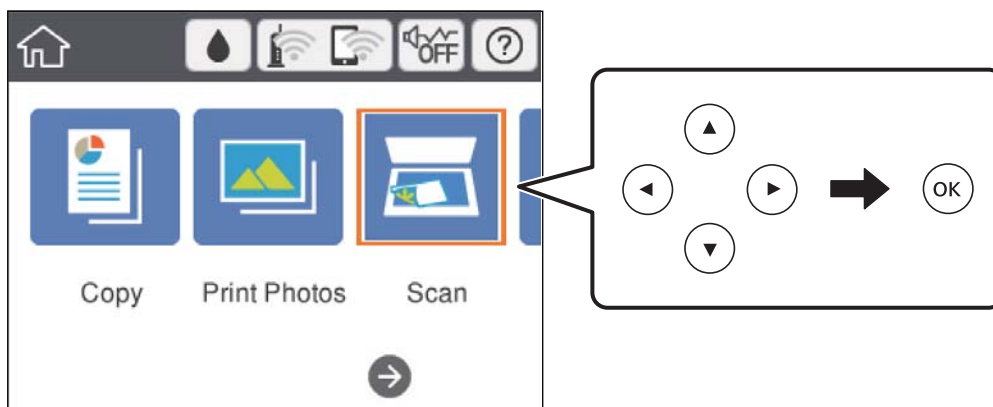

3. Select **Computer**.
4. Select **+** to select the computer to which you want to save the scanned images.

### Note:

When the printer is connected to a network, you can select the computer to which you want to save the scanned image. You can display up to 20 computers on the printer's control panel. If you set **Network Scan Name (Alphanumeric)** on *Epson Event Manager*, it is displayed on the control panel.

5. Select **+** to select how to save the scanned image to a computer.
  - Save as JPEG: Saves the scanned image in JPEG format.
  - Save as PDF: Saves the scanned image in PDF format.
  - Attach to e-mail: Starts the email client on your computer, and then automatically attaches it to an email.
  - Follow custom setting: Saves the scanned image using the settings on the *Epson Event Manager*. You can change the scan settings such as the scanning size, folder to save to, or save format.
6. Press the **◇** button.

### Note:

The color, size, and border of the scanned image will not be exactly the same as the original.

## Scanning

### Related Information

- ➔ [“Placing Originals on the Scanner Glass” on page 72](#)
- ➔ [“Application for Configuring Scanning Operations from the Control Panel \(Epson Event Manager\)” on page 195](#)

## Making Custom Settings in Epson Event Manager

You can set the scan settings for **Follow custom setting** in Epson Event Manager.

See the Epson Event Manager help for details.

1. Start Epson Event Manager.
2. Make sure that your scanner is selected as the **Scanner** on the **Button Settings** tab on the main screen.

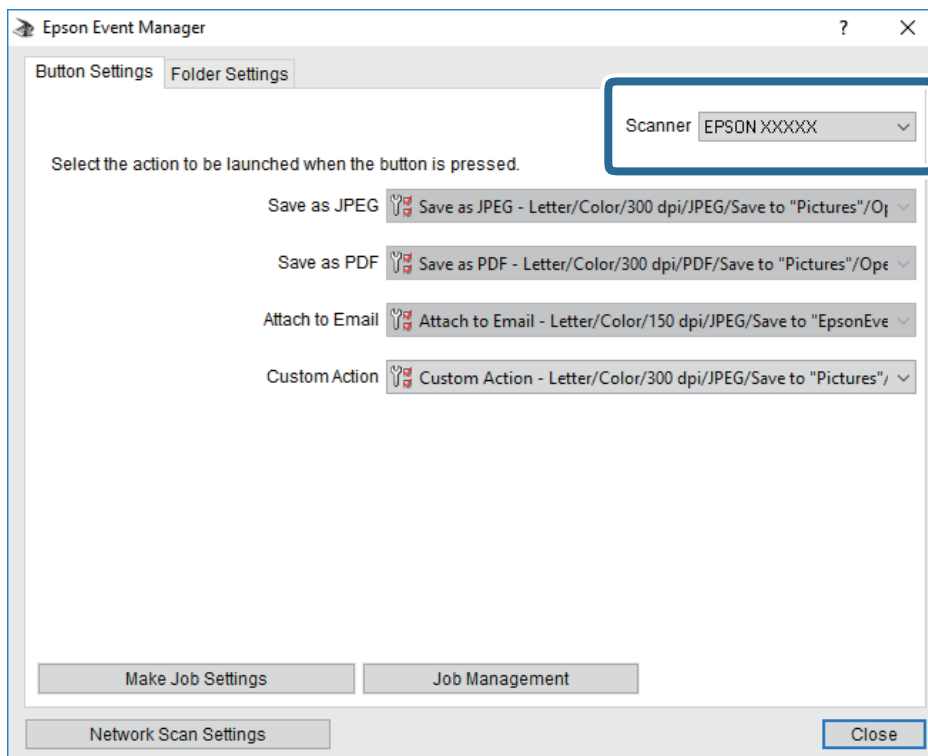

## Scanning

3. Click **Make Job Settings**.

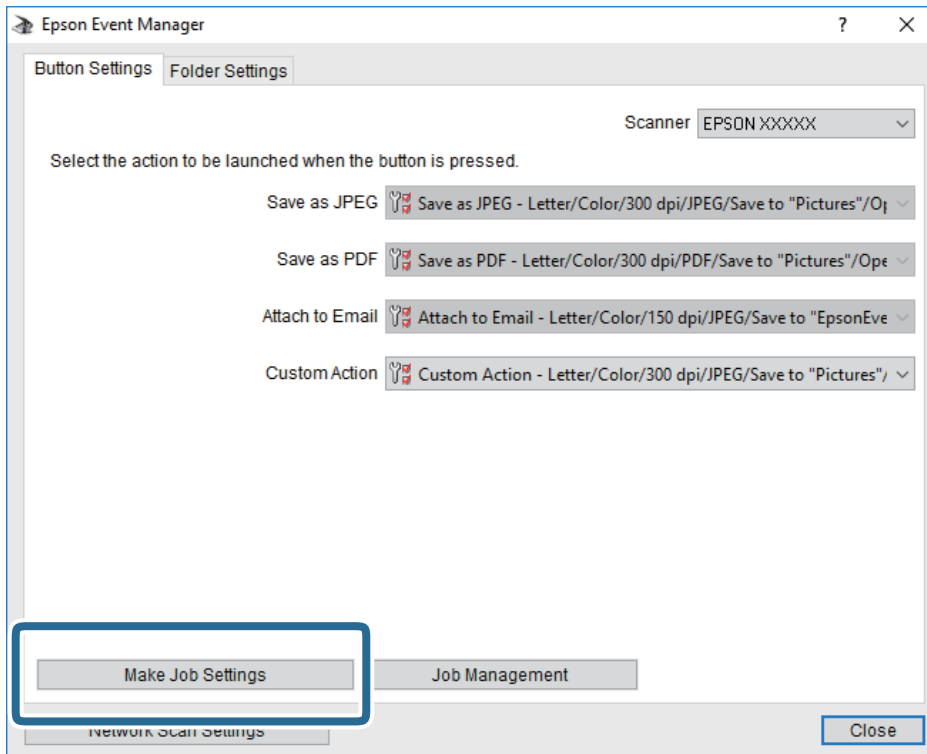

## Scanning

4. Make scan settings on the **Job Settings** screen.

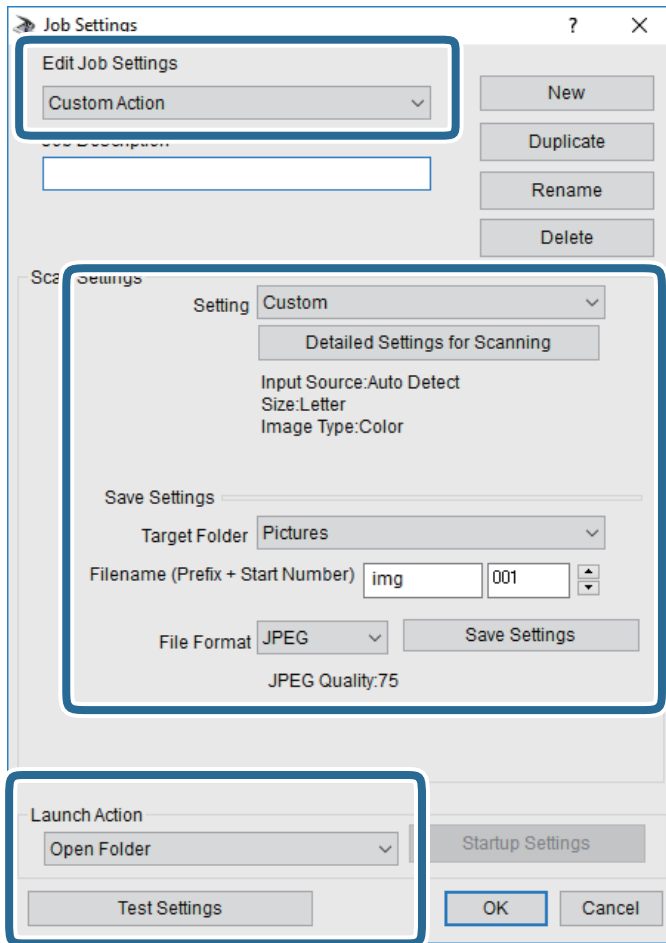

- Edit Job Settings: Select **Custom Action**.
- Setting: Scan using the best settings for the selected type of original. Click **Detailed Settings for Scanning** to set the items such as the resolution or the color for saving the scanned image.
- Target Folder: Select the save folder for the scanned image.
- Filename (Prefix + Start Number): Change the settings for the file name you want to save.
- File Format: Select the save format.
- Launch Action: Select the action when scanning.
- Test Settings: Starts test scanning using current settings.

5. Click **OK** to return to the main screen.

## Scanning

6. Make sure that the **Custom Action** is selected on the **Custom Action** list.

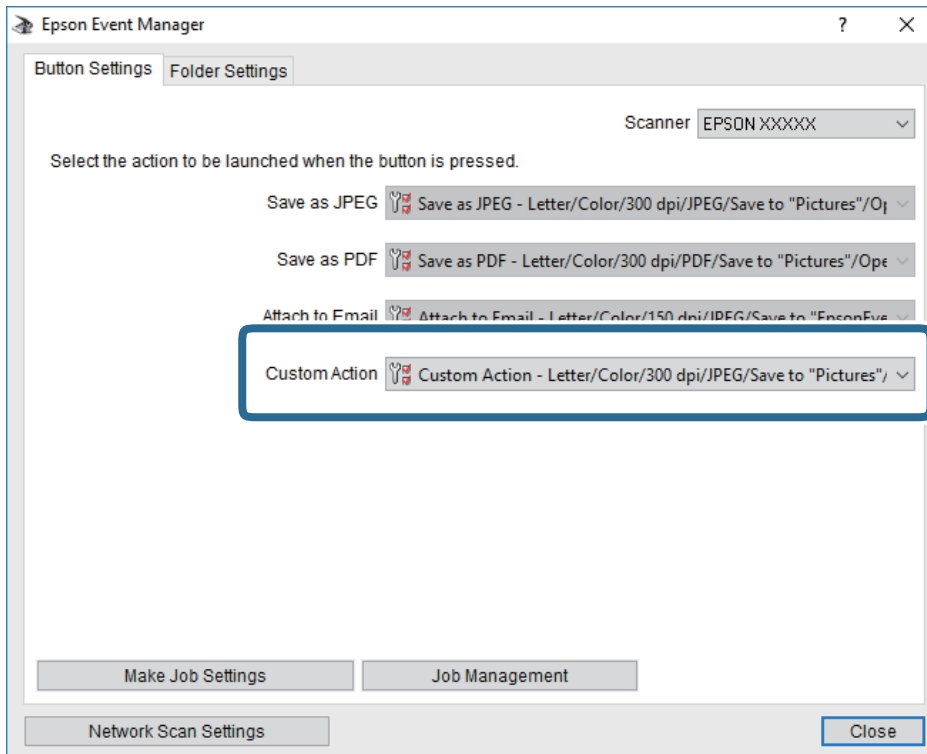

7. Click **Close** to close Epson Event Manager.

### Related Information

➔ “Application for Configuring Scanning Operations from the Control Panel (Epson Event Manager)” on page 195

## Scanning to the Cloud

You can send scanned images to cloud services. Before using this feature, make settings using Epson Connect. See the following Epson Connect portal website for details.

<https://www.epsonconnect.com/>

<http://www.epsonconnect.eu> (Europe only)

### Note:

*You cannot save multiple originals as one PDF file when scanning from the control panel. By using Epson Scan 2 and setting **Add or edit pages after scanning** on the **Document Mode**, you can scan additional originals after you scanned the original, and then save as one file.*

1. Make sure that you have made settings using Epson Connect.
2. Place the originals.

## Scanning

3. Select **Scan** on the home screen.

To select an item, move the focus to the item using the ▲▼◀▶ buttons, and then press the OK button.

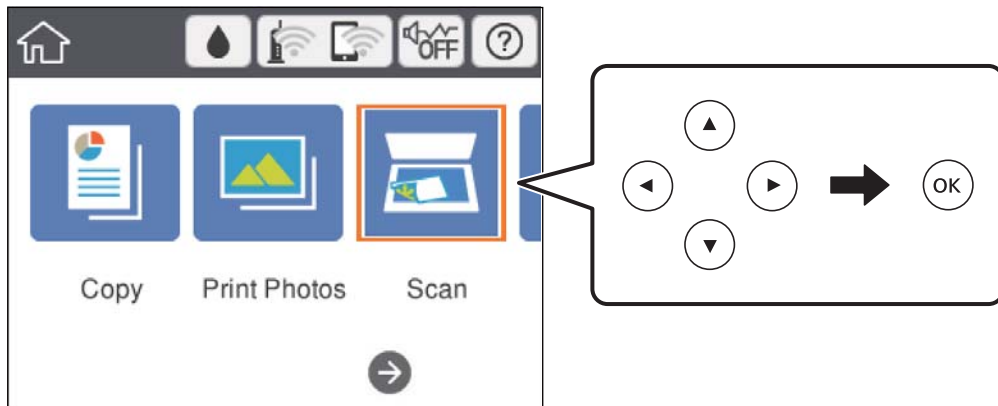

4. Select **Cloud**.
5. Select **+** on the top of the screen, and then select a destination.
6. Set items on **Scan** tab, such as the save format.
  - B&W/Color: Select whether to scan in color or in monochrome.
  - JPEG/PDF: Select the format in which to save the scanned image.
7. Select **Advanced Settings** tab, and then check settings, and change them if necessary.
8. Select **Scan** tab, and then press the **◇** button.

**Note:**

*The color, size, and border of the scanned image will not be exactly the same as the original.*

### Related Information

➔ [“Placing Originals on the Scanner Glass” on page 72](#)

## Basic Menu Options for Scanning to the Cloud

**B&W/Color:**

Select whether to scan in color or in monochrome.

**JPEG/PDF:**

Select the format in which to save the scanned image.

## Advanced Menu Options for Scanning to the Cloud

**Original Type:**

Select the type of your original.

## Scanning

### Scan Settings:

Scan Size:

Select the scan size. To crop the white space around the text or image when scanning, select **Auto Cropping**. To scan at the maximum area of the scanner glass, select **Max Area**.

Original Orientation:

Select the orientation of the original.

### Contrast:

Select the contrast of the scanned image.

### Clear All Settings:

Resets the scan settings to their defaults.

## Scanning Using WSD

**Note:**

- This feature is only available for computers running Windows 10/Windows 8.1/Windows 8/Windows 7/Windows Vista.
- If you are using Windows 7/Windows Vista, you need to setup your computer in advance using this feature.

1. Place the originals.
2. Select **Scan** on the home screen.

To select an item, move the focus to the item using the ▲▼◀▶ buttons, and then press the OK button.

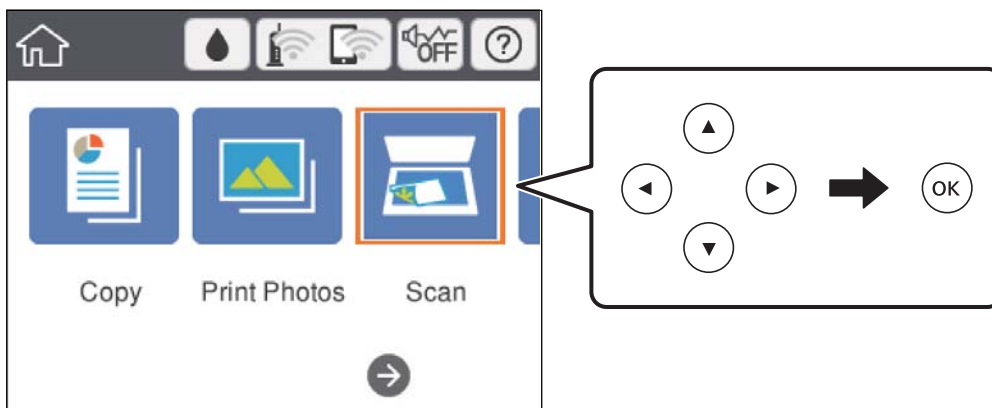

3. Select **WSD**.
4. Select a computer.
5. Press the **◆** button.

**Note:**

The color, size, and border of the scanned image will not be exactly the same as the original.

## Scanning

### Setting Up a WSD Port

This section explains how to set up a WSD port for Windows 7/Windows Vista.

**Note:**

For Windows 10/Windows 8.1/Windows 8, the WSD port is set up automatically.

The following is necessary to set up a WSD port.

- The printer and the computer are connected to the network.
- The printer driver is installed on the computer.

1. Turn the printer on.
2. Click start, and then click **Network** on the computer.
3. Right-click the printer, and then click **Install**.  
Click **Continue** when the **User Account Control** screen is displayed.  
Click **Uninstall** and start again if the **Uninstall** screen is displayed.

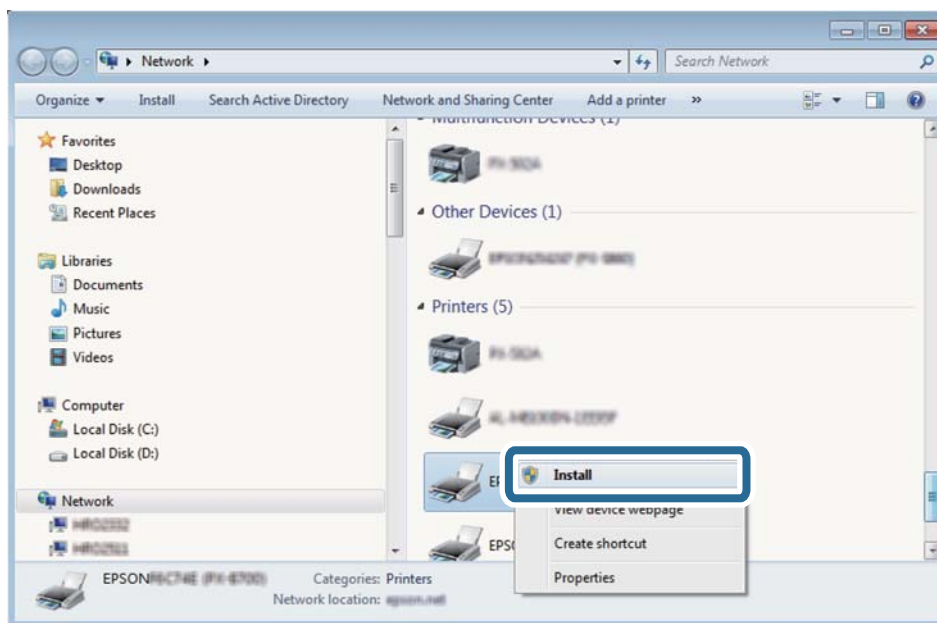

**Note:**

The printer name you set on the network and model name (EPSON XXXXXX (XX-XXXX)) are displayed on the network screen. You can check the printer's name set on the network from the printer's control panel or by printing a network status sheet.



## Scanning

- Click **Your device is ready to use**.

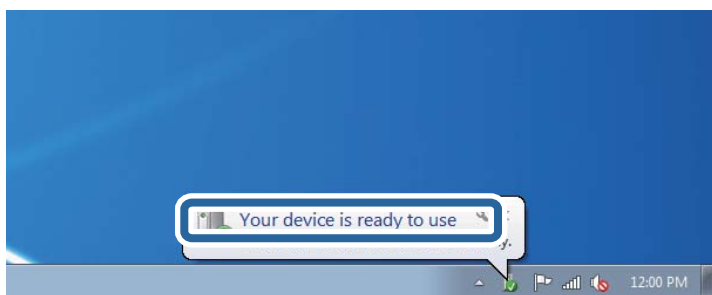

- Check the message, and then click **Close**.

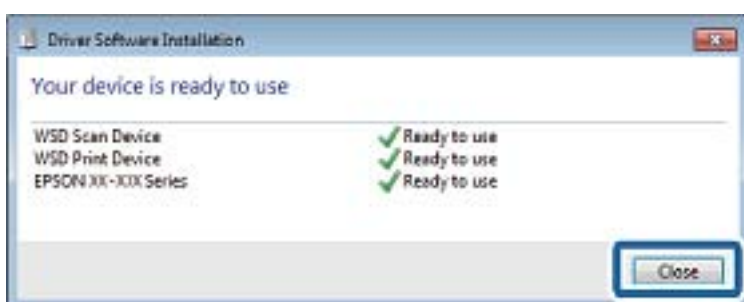

- Open the **Devices and Printers** screen.

- Windows 7

Click start > **Control Panel** > **Hardware and Sound** (or **Hardware**) > **Devices and Printers**.

- Windows Vista

Click start > **Control Panel** > **Hardware and Sound** > **Printers**.

- Check that an icon with the printer's name on the network is displayed.

Select the printer name when using with WSD.

## Scanning from a Computer

### Scanning Using Epson Scan 2

You can scan by using the scanner driver "Epson Scan 2". See the Epson Scan 2 help for an explanation of each setting item.

#### Related Information

➔ ["Application for Scanning Documents and Images \(Epson Scan 2\)" on page 194](#)

### Scanning Documents (Document Mode)

Using **Document Mode** in Epson Scan 2, you can scan originals using detailed settings that are suitable for text documents.

## Scanning

1. Place the originals.
2. Start Epson Scan 2.
3. Select **Document Mode** from the **Mode** list.
4. Make the following settings on the **Main Settings** tab.

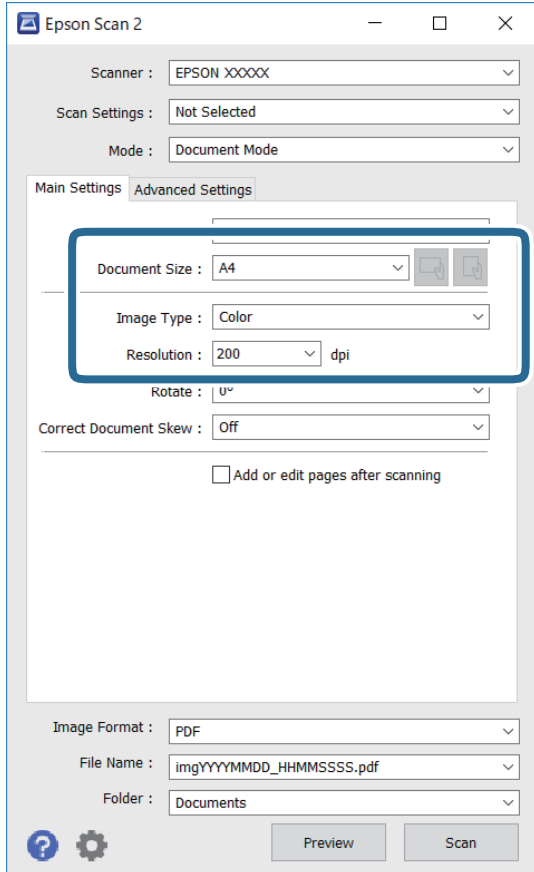

- Document Size: Select the size of the original you placed.



- (Original orientation) buttons: Select the set orientation of the original you placed. Depending on the size of the original, this item may be set automatically and cannot be changed.

- Image Type: Select the color for saving the scanned image.

- Resolution: Select the resolution.

**Note:**

- The **Document Source** setting is fixed as **Scanner Glass**. You cannot change this setting.
- If you set **Add or edit pages after scanning**, you can scan additional originals after scanning the original. In addition, if you set the **Image Format** as PDF or Multi-TIFF, you can save the scanned images as one file.

5. Make other scan settings if necessary.

- You can preview the scanned image by clicking the **Preview** button. The preview window opens, and the previewed image is displayed.

## Scanning

- ❑ On the **Advanced Settings** tab, you can make detailed image adjustment settings that are suitable for text documents, such as the following.
  - ❑ **Remove Background:** Remove the background of the originals.
  - ❑ **Text Enhancement:** You can make blurred letters in the original clear and sharp.
  - ❑ **Auto Area Segmentation:** You can make letters clear and images smooth when performing black and white scanning for a document that contains images.
  - ❑ **Color Enhance:** You can enhance the color specified for the scanned image, and then save it in grayscale or black and white.
  - ❑ **Brightness:** You can adjust the brightness for the scanned image.
  - ❑ **Contrast:** You can adjust the contrast for the scanned image.
  - ❑ **Gamma:** You can adjust the gamma (brightness of the intermediate range) for the scanned image.
  - ❑ **Threshold:** You can adjust the border for monochrome binary (black and white).
  - ❑ **Unsharp Mask:** You can enhance and sharpen the outlines of the image.
  - ❑ **Descreening:** You can remove moiré patterns (web-like shadows) that appear when scanning printed papers such as a magazine.
  - ❑ **Edge Fill:** You can remove the shadow created around the scanned image.
  - ❑ **Dual Image Output (Windows Only):** You can scan once and save two images with different output settings at the same time.

**Note:**

*The items may not be available depending on other settings you made.*

## Scanning

### 6. Set the file saving settings.

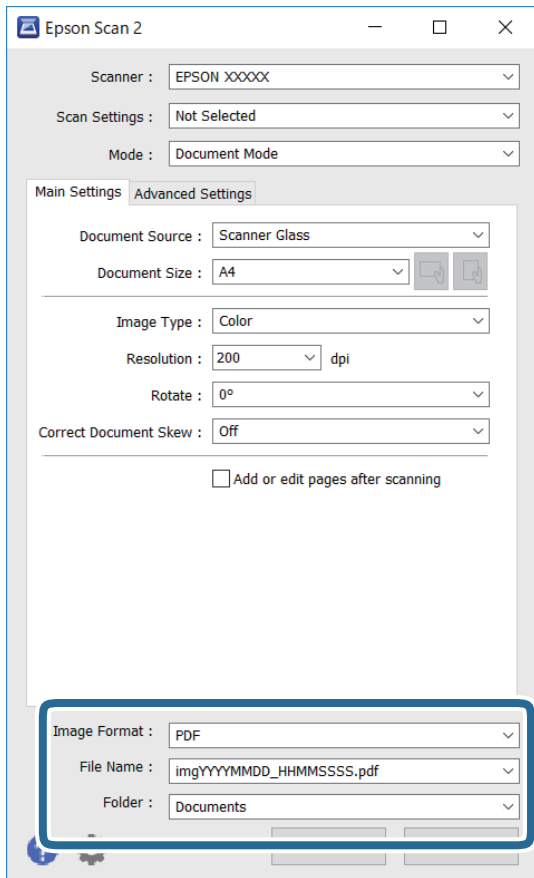

- Image Format:** Select the save format from the list.

You can make detailed settings for each save format except BITMAP and PNG. Select **Options** from the list after selecting the save format.

- File Name:** Confirm the save file name displayed.

You can change settings for the file name by selecting **Settings** from the list.

- Folder:** Select the save folder for the scanned image from the list.

You can select another folder or create a new folder by selecting **Select** from the list.

### 7. Click **Scan**.

#### Related Information

➔ [“Placing Originals on the Scanner Glass” on page 72](#)

## Scanning Photos or Pictures (Photo Mode)

Using **Photo Mode** in Epson Scan 2, you can scan originals with wide variety of image adjustment features that are suitable for photos or pictures.

### 1. Place the originals.

By placing multiple originals on the scanner glass, you can scan them all at the same time. Make sure there is a gap of at least 20 mm between the originals.

## Scanning

2. Start Epson Scan 2.
3. Select **Photo Mode** from the **Mode** list.
4. Make the following settings on the **Main Settings** tab.

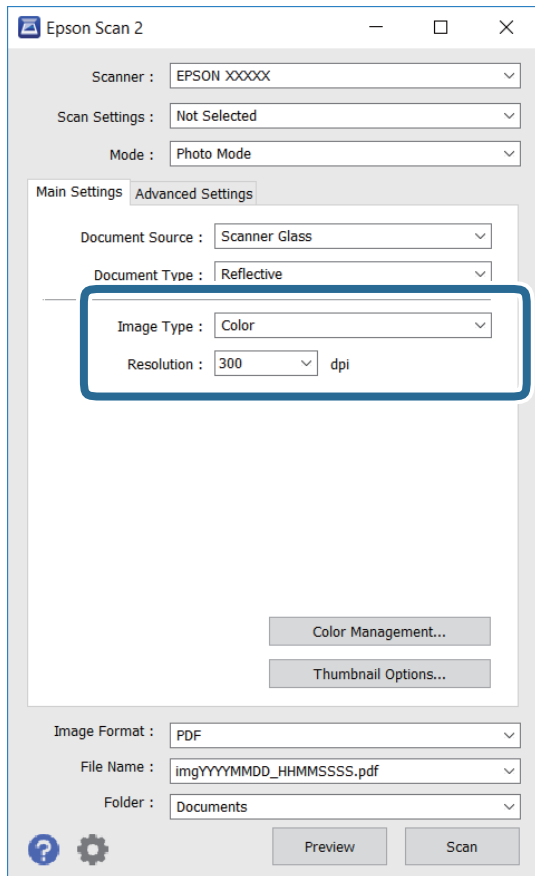

- Image Type: Select the color for saving the scanned image.
- Resolution: Select the resolution.

**Note:**

The **Document Source** setting is fixed as **Scanner Glass**, and the **Document Type** setting is fixed as **Reflective**. (**Reflective** means originals which are not transparent, for example ordinary papers or photos.) You cannot change these settings.

## Scanning

5. Click **Preview**.

The preview window opens, and the previewed images are displayed as thumbnails.

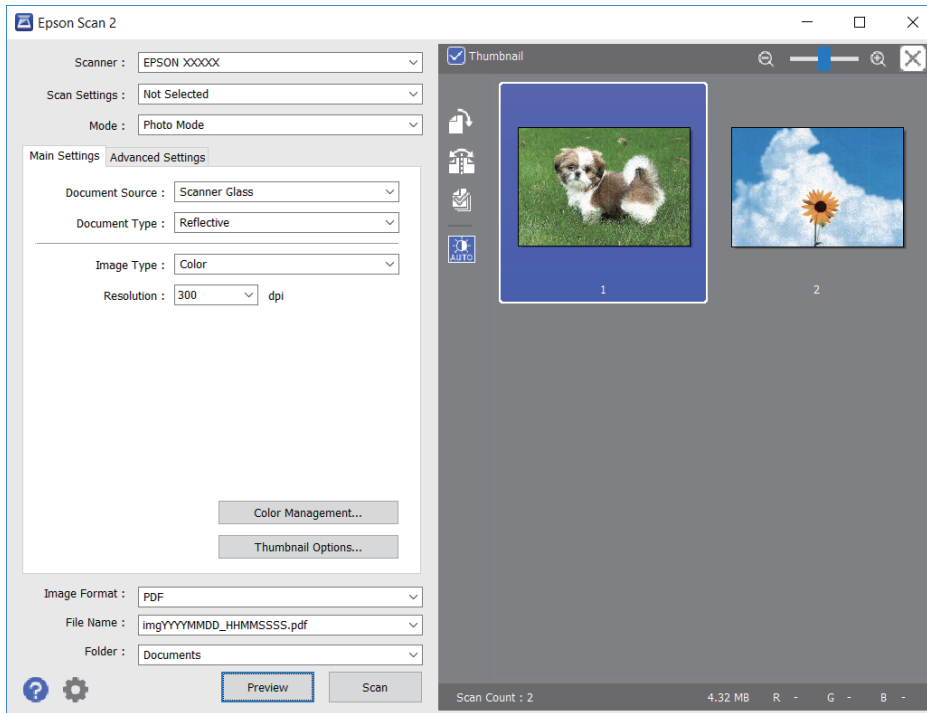

**Note:**

To preview the entire scanned area, clear the **Thumbnail** check box at the top of the preview window.

6. Confirm the preview, and make image adjustment settings on the **Advanced Settings** tab if necessary.

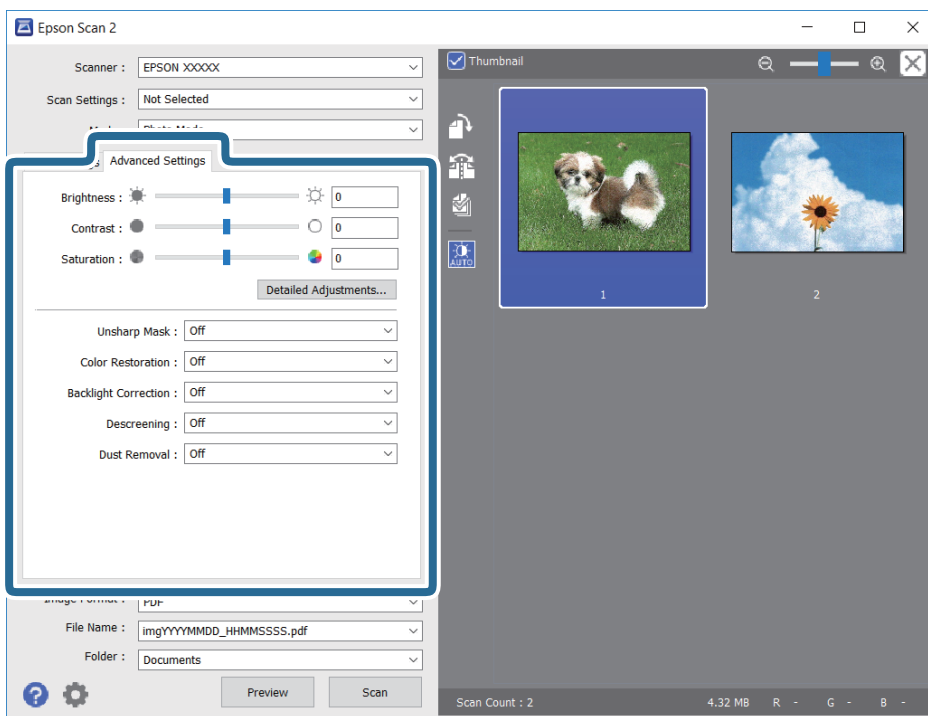

## Scanning

You can adjust the scanned image using detailed settings that are suitable for photos or pictures, such as the following.

- Brightness:** You can adjust the brightness for the scanned image.
- Contrast:** You can adjust the contrast for the scanned image.
- Saturation:** You can adjust the saturation (color vividness) for the scanned image.
- Unsharp Mask:** You can enhance and sharpen the outlines of the scanned image.
- Color Restoration:** You can correct images that have faded to return them to their original colors.
- Backlight Correction:** You can lighten scanned images that are dark due to backlight.
- Descreening:** You can remove moiré patterns (web-like shadows) that appear when scanning printed papers such as a magazine.
- Dust Removal:** You can remove dust on the scanned image.

**Note:**

- The items may not be available depending on other settings you made.*
- Depending on the original, the scanned image may not be adjusted correctly.*
- When multiple thumbnails are created, you can adjust the image quality for each thumbnail. Depending on the adjustment items, you can adjust the quality of scanned images all together by selecting multiple thumbnails.*

### 7. Set the file saving settings.

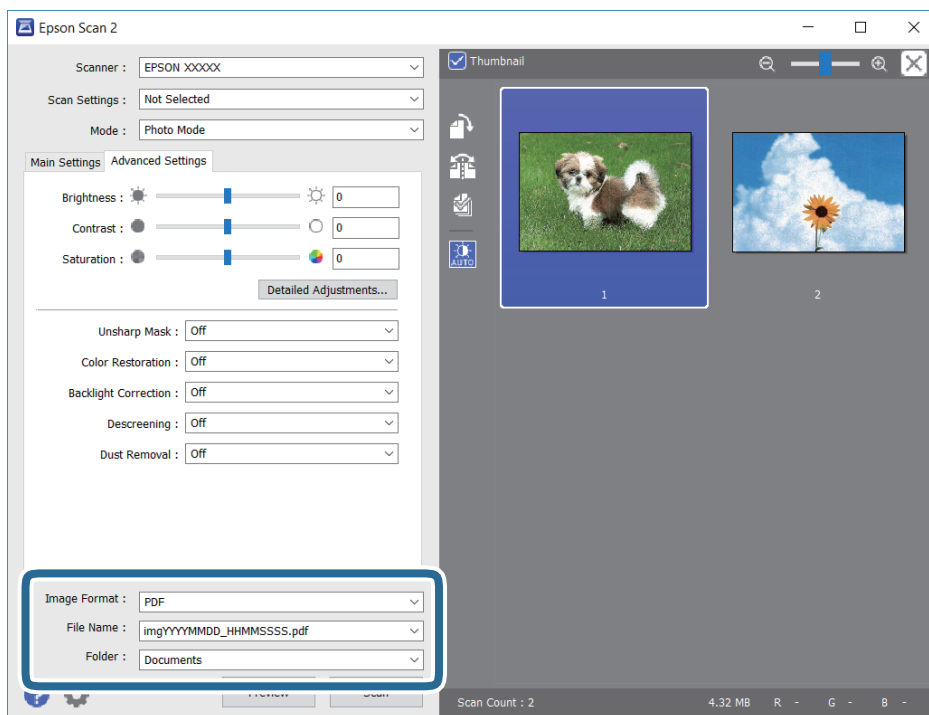

- Image Format:** Select the save format from the list.  
You can make detailed settings for each save format except BITMAP and PNG. Select **Options** from the list after selecting the save format.
- File Name:** Confirm the save file name displayed.  
You can change settings for the file name by selecting **Settings** from the list.

## Scanning

- ❑ Folder: Select the save folder for the scanned image from the list.

You can select another folder or create a new folder by selecting **Select** from the list.

8. Click **Scan**.

### Related Information

- ➔ “Placing Originals on the Scanner Glass” on page 72
- ➔ “Placing Multiple Photos for Scanning at the Same Time” on page 74

---

## Scanning from Smart Devices

Epson iPrint is an application that allows you to scan photos and documents from a smart device, such as a smartphone or tablet, that is connected to the same wireless network as your printer. You can save the scanned data on a smart device or to Cloud services, send it by email, or print it.

If you start Epson iPrint when the printer is not connected to the network, a message is displayed instructing you to connect to the printer. Follow the instructions to complete the connection. See the URL below for the operating conditions.

<http://epson.sn>



### Installing Epson iPrint

You can install Epson iPrint on your smart device from the following URL or QR code.

<http://ipr.to/a>



### Scanning Using Epson iPrint

Start Epson iPrint from your smart device and select the item you want to use from the home screen.



## Scanning

The following screens are subject to change without notice.

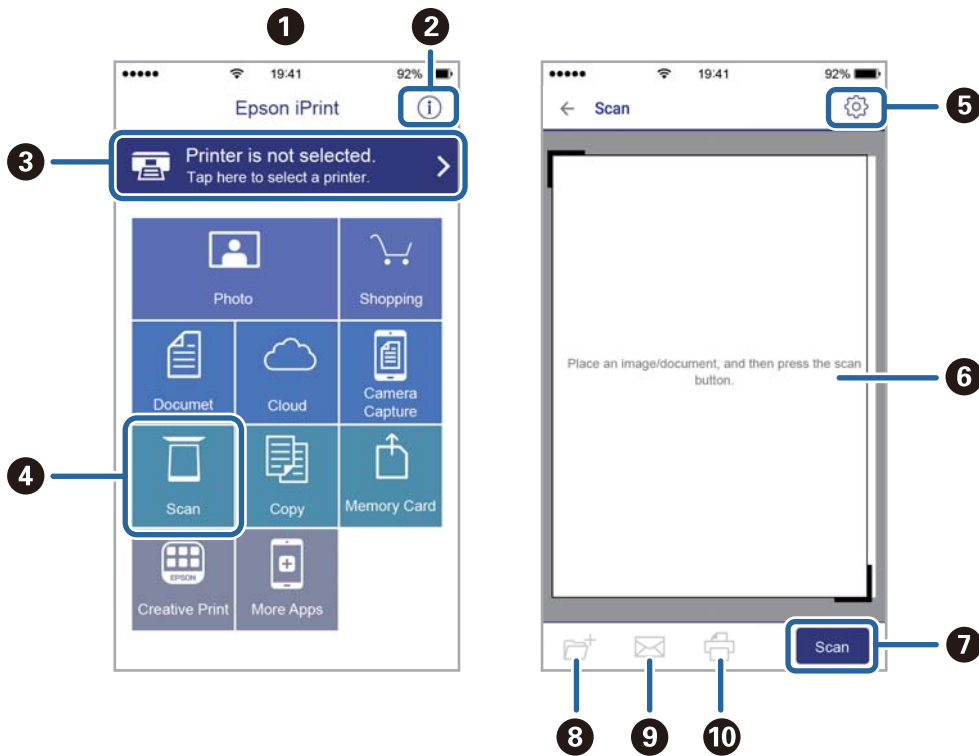

1	Home screen displayed when the application is started.
2	Displays information on how to setup the printer and a FAQ.
3	Displays the screen where you can select the printer and make printer settings. Once you have selected the printer, you do not need to select it again from the next time.
4	Displays the scanning screen.
5	Displays the screen where you can make scan settings such as resolution.
6	Displays scanned images.
7	Starts scanning.
8	Displays the screen where you can save scanned data to a smart device or Cloud services.
9	Displays the screen where you can send scanned data by email.
10	Displays the screen where you can print scanned data.

# Replacing Ink Cartridges and Other Consumables

---

## Checking the Status of the Remaining Ink and the Maintenance Box

You can check the approximate ink levels and the approximate service life of the maintenance box from the control panel or the computer.

**Note:**

*You can continue printing while the ink low message is displayed. Replace the ink cartridges when required.*

### Checking the Status of the Remaining Ink and the Maintenance Box - Control Panel

1. Select **Settings** on the home screen.

To select an item, move the focus to the item using the ▲ ▼ ◀ ▶ buttons, and then press the OK button.

2. Select **Supply Status**.

### Checking the Status of the Remaining Ink and the Maintenance Box - Windows

1. Access the printer driver window.
2. Click **EPSON Status Monitor 3** on the **Maintenance** tab, and then click **Details**.

**Note:**

*If EPSON Status Monitor 3 is disabled, click **Extended Settings** on the **Maintenance** tab, and then select **Enable EPSON Status Monitor 3**.*

#### Related Information

➔ [“Windows Printer Driver” on page 188](#)

### Checking the Status of the Remaining Ink and the Maintenance Box - Mac OS

1. Select **System Preferences** from the  menu > **Printers & Scanners** (or **Print & Scan**, **Print & Fax**), and then select the printer.
2. Click **Options & Supplies** > **Utility** > **Open Printer Utility**.

## Replacing Ink Cartridges and Other Consumables

- Click EPSON Status Monitor.

### Ink Cartridge Codes

The following are the codes for genuine Epson ink cartridges.

**Note:**

- Ink cartridge codes may vary by location. For the correct codes in your area, contact Epson support.
- Although the ink cartridges may contain recycled materials, this does not affect printer function or performance.
- Specifications and appearance of the ink cartridge are subject to change without prior notice for improvement.

For Europe

Icon	BK: Black	PB: Photo Black	C: Cyan	M: Magenta	Y: Yellow
Kiwi 	202 202XL*	202 202XL*	202 202XL*	202 202XL*	202 202XL*

\* "XL" indicates a large cartridge.

**Note:**

For users in Europe, visit the following website for information on Epson's ink cartridge yields.

<http://www.epson.eu/pageyield>

For Australia and New Zealand

BK: Black	PB: Photo Black	C: Cyan	M: Magenta	Y: Yellow
302 302XL*	302 302XL*	302 302XL*	302 302XL*	302 302XL*

\* "XL" indicates a large cartridge.

Epson recommends the use of genuine Epson ink cartridges. Epson cannot guarantee the quality or reliability of non-genuine ink. The use of non-genuine ink may cause damage that is not covered by Epson's warranties, and under certain circumstances, may cause erratic printer behavior. Information about non-genuine ink levels may not be displayed.

#### Related Information

➔ ["Technical Support Web Site" on page 249](#)

---

## Ink Cartridge Handling Precautions

### Storing precautions for ink

- Keep the ink cartridges out of direct sunlight.
- Do not store the ink cartridges in high or freezing temperatures.
- Epson recommends using the ink cartridge before the date printed on the package.
- For best results, use up ink cartridge within six months of opening the package.
- For best results, store ink cartridge packages with their bottom down.
- After bringing an ink cartridge inside from a cold storage site, allow it to warm up at room temperature for at least three hours before using it.
- Do not open the ink cartridge package until you are ready to install it in the printer. The cartridge is vacuum packed to maintain its reliability. If you leave a cartridge unpacked for a long time before using it, normal printing may not be possible.

### Handling precautions for replacing ink cartridges

- Do not touch the sections shown in the illustration. Doing so may prevent normal operation and printing.

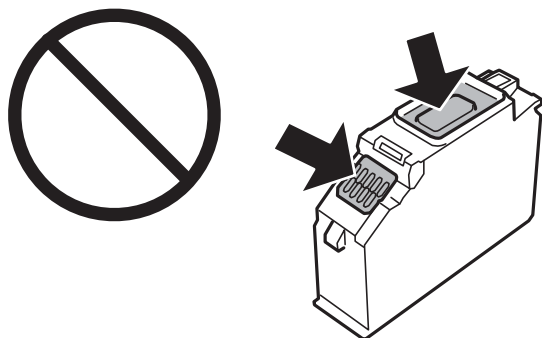

- Install all ink cartridges; otherwise you cannot print.
- Do not replace ink cartridges with the power off. Do not move the print head by hand; otherwise, you may damage the printer.
- After installing the ink cartridge, the power light continues to flash while the printer is charging ink. Do not turn off the printer during ink charging. If the ink charging is incomplete, you may not be able to print.
- Do not leave the printer with the ink cartridges removed or do not turn off the printer during cartridge replacement. Otherwise, ink remaining in the print head nozzles will dry out and you may not be able to print.
- Be careful not to let dust or any objects get inside the ink cartridge holder. Anything inside the holder may adversely affect the printing results or result in an inability to print. If anything gets inside the holder, remove it carefully.

## Replacing Ink Cartridges and Other Consumables

- ❑ If you remove the cartridge from the printer for later use or to dispose of it, make sure you put the cap back on the cartridge's ink supply port to prevent ink from drying out or to prevent surrounding areas from getting smeared by ink. Place the cap securely until it clicks into place.

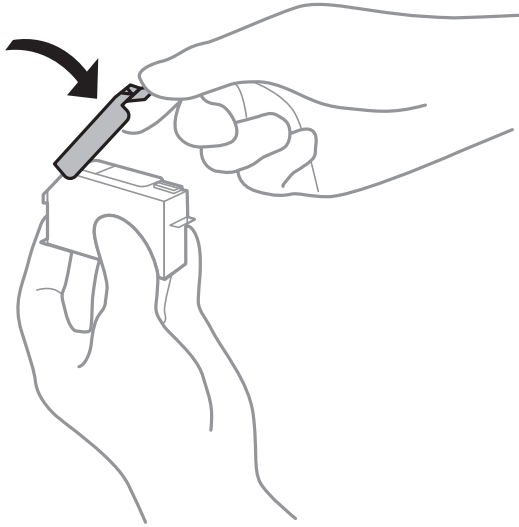

- ❑ If you remove an ink cartridge from the printer for later use, Epson recommends using it up as soon as possible.
- ❑ This printer uses ink cartridges equipped with a green chip that monitors information such as the amount of remaining ink for each cartridge. This means that even if the cartridge is removed from the printer before it is expended, you can still use the cartridge after reinserting it back into the printer. However, when reinserting a cartridge, some ink may be consumed to guarantee printer performance.
- ❑ For maximum ink efficiency, only remove an ink cartridge when you are ready to replace it. Ink cartridges with low ink status may not be used when reinserted.
- ❑ To ensure you receive premium print quality and to help protect your print head, a variable ink safety reserve remains in the cartridge when your printer indicates to replace the cartridge. The yields quoted for you do not include this reserve.
- ❑ Do not disassemble or remodel the ink cartridge, otherwise you may not be able to print normally.
- ❑ You cannot use the cartridges that came with the printer for the replacement.
- ❑ Finish ink cartridge replacement promptly. Do not leave the printer with the ink cartridges removed.

### Consumption of Ink

- ❑ To maintain optimum print head performance, some ink is consumed from all cartridges during maintenance operations. Ink may also be consumed when you replace ink cartridges or turn the printer on.
- ❑ When printing in monochrome or grayscale, color inks instead of black ink may be used depending on the paper type or print quality settings. This is because a mixture of color inks is used to create black.
- ❑ The ink in the ink cartridges supplied with your printer is partly used during initial setup. In order to produce high quality printouts, the print head in your printer will be fully charged with ink. This one-off process consumes a quantity of ink and therefore these cartridges may print fewer pages compared to subsequent ink cartridges.
- ❑ Quoted yields may vary depending on the images that you are printing, the paper type that you are using, the frequency of your prints and environmental conditions such as temperature.

## Replacing Ink Cartridges

**Caution:**

Be careful not to trap your hand or fingers when opening or closing the scanner unit. Otherwise you may be injured.

**Important:**

When replacing ink cartridges, replace them at the correct replacement position. If you replace these in the wrong position, a recognition error occurs. If an error occurs, reinsert these in the correct replacement position.

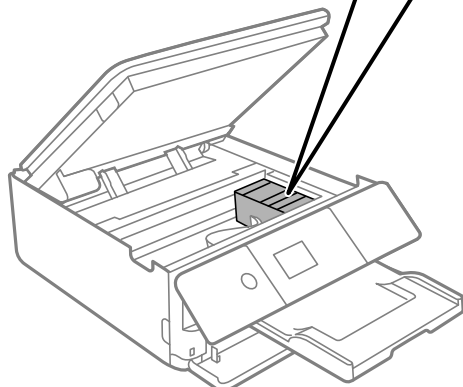
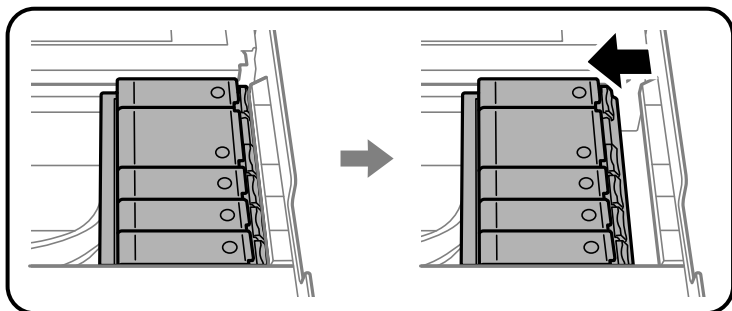
**Note:**

You can continue printing even after the printer indicates that the ink is low. However, prepare new ink cartridges as soon as possible.

1. If the CD/DVD tray has been inserted, remove the tray.
2. Do one of the following.
  - When prompted to replace ink cartridges:  
Check which ink cartridge needs to be replaced, select **Next**, and then select **Yes, replace now**.
  - When replacing ink cartridges before they are expended:  
Select **Maintenance** > **Ink Cartridge Replacement** from the home screen.

To select an item, move the focus to the item using the ▲ ▼ ◀ ▶ buttons, and then press the OK button.

### Replacing Ink Cartridges and Other Consumables

- When replacing the black ink cartridge, gently shake the new black ink cartridge four or five times and then remove it from its package. When replacing other color cartridges and the photo black cartridge, remove the new color cartridges and the photo black cartridge from their package without shaking.

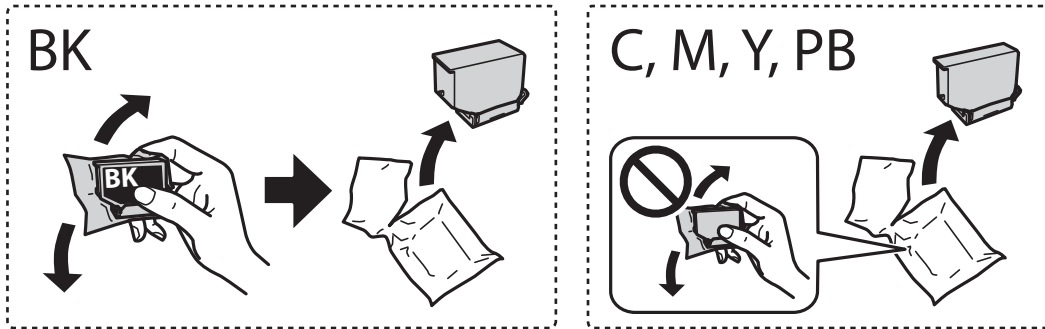

**!** **Important:**

*Do not shake cartridges after opening the package, as they may leak.*

- Remove the new ink cartridge from its package, and then select **Next**.

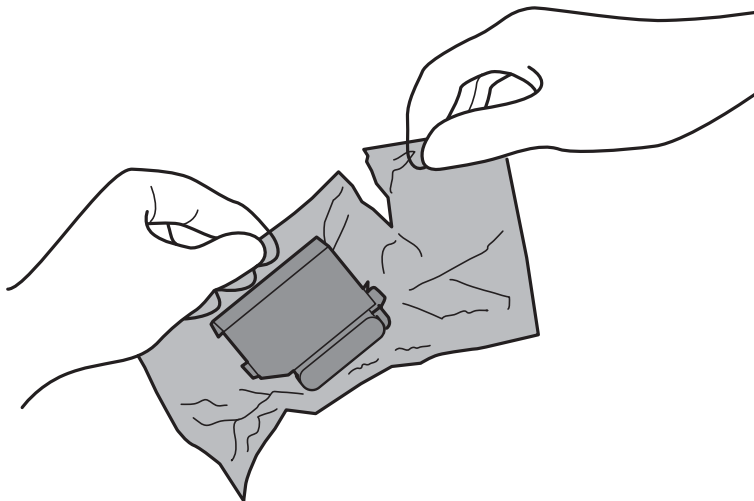

## Replacing Ink Cartridges and Other Consumables

5. Make sure the cap is facing up, and then remove it.

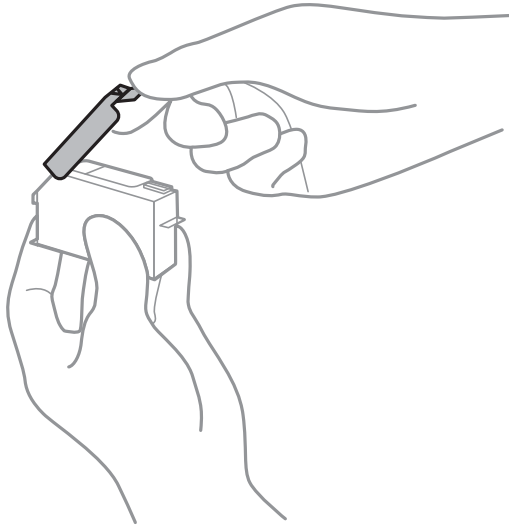

**!** *Important:*

*Do not touch the sections shown in the illustration. Doing so may prevent normal operation and printing.*

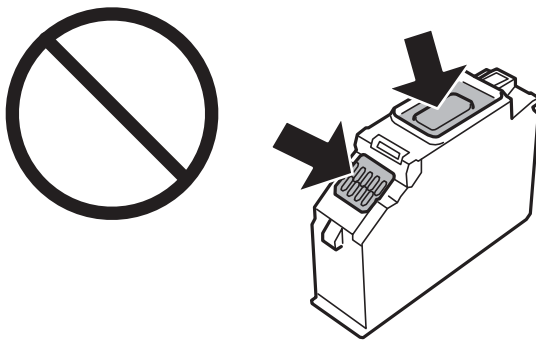

6. Open the scanner unit with the document cover closed.

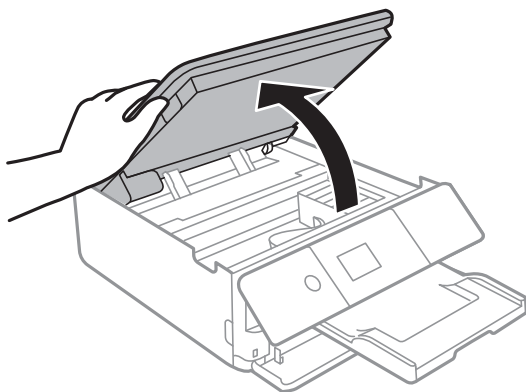

7. Confirm the message, and then press the Start button.

The ink cartridge holder moves to the replacement position. However, the ink cartridge holder may return after a few minutes. In that case, repeat steps 2 to 7.



## Replacing Ink Cartridges and Other Consumables

8. Push the tab to unlock the ink cartridge holder, and then remove the cartridge diagonally.

**!** *Important:*

*Replace ink cartridges one after another as soon as possible. If you replace two or more cartridges at a time or if replacement takes time, some ink may be consumed to guarantee printer performance.*

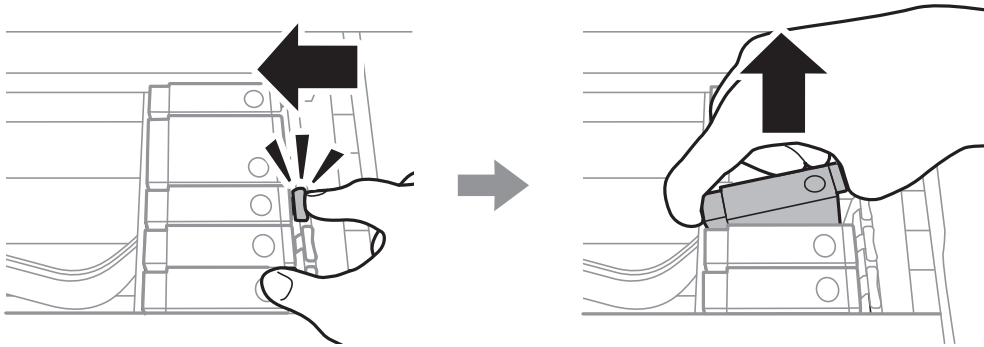

9. Insert the ink cartridge diagonally into the cartridge holder and gently push it down until it clicks into place.

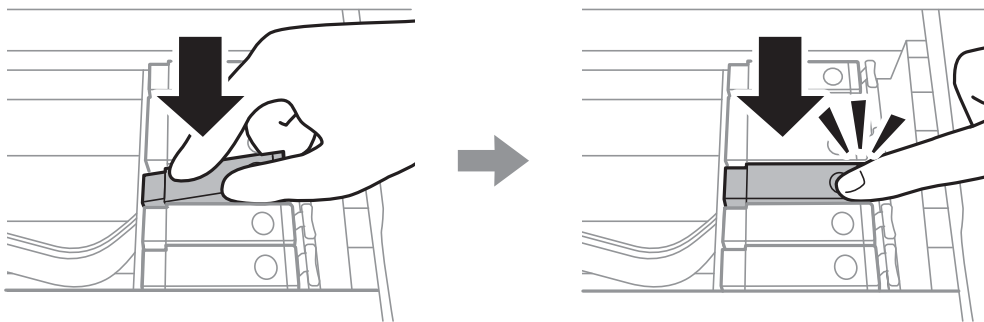

10. Close the scanner unit, and then select **Completed**.

## Replacing Ink Cartridges and Other Consumables

11. Follow the on-screen instructions.

**!** *Important:*

- ❑ *If you remove the cartridge from the printer for later use or to dispose of it, make sure you put the cap back on the cartridge's ink supply port to prevent ink from drying out or to prevent surrounding areas from getting smeared by ink. Place the cap securely until it clicks into place.*

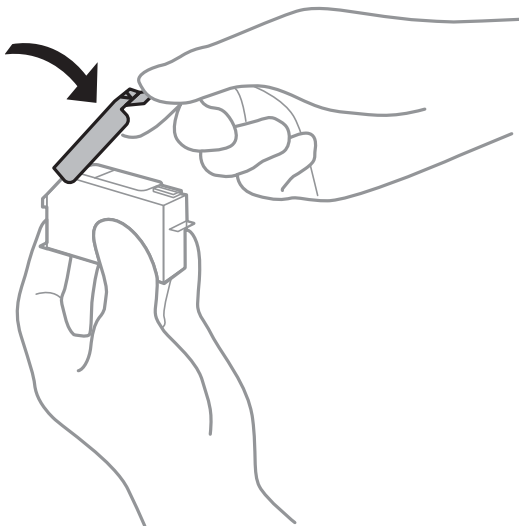

- ❑ *After installing the ink cartridge, the power light continues to flash while the printer is charging ink. Do not turn off the printer during ink charging. If the ink charging is incomplete, you may not be able to print.*
- ❑ *Do not insert the CD/DVD tray until ink charging is complete.*

### Related Information

- ➔ [“Ink Cartridge Codes” on page 155](#)
- ➔ [“Ink Cartridge Handling Precautions” on page 156](#)

---

## Maintenance Box Code

The maintenance box can be purchased and replaced by the user.

Epson recommends the use of a genuine Epson maintenance box.

The following is the code for the genuine Epson maintenance box.

T3661

**!** *Important:*

*Once a maintenance box has been installed in a printer it cannot be used with other printers.*

---

## Maintenance Box Handling Precautions

Read the following instructions before replacing the maintenance box.

## Replacing Ink Cartridges and Other Consumables

- Do not touch the green chip on the side of the maintenance box. Doing so may prevent normal operation and printing.
- Do not replace the maintenance box during printing; otherwise, ink may leak.
- Do not remove the maintenance box and its cover except when replacing the maintenance box; otherwise ink may leak.
- Do not reuse a maintenance box which has been removed and left detached for a long period. Ink inside the box will have solidified and no more ink can be absorbed.
- Do not tilt the used maintenance box until after it is sealed in the plastic bag; otherwise ink may leak.
- Do not store the maintenance box in high or freezing temperatures.
- Keep the maintenance box out of direct sunlight.

---

## Replacing a Maintenance Box

In some print cycles a very small amount of surplus ink may be collected in the maintenance box. To prevent ink leakage from the maintenance box, the printer is designed to stop printing when the absorbing capacity of the maintenance box has reached its limit. Whether and how often this is required will vary according to the number of pages you print, the type of material that you print and the number of cleaning cycles that the printer performs. When a message is displayed prompting you to replace the maintenance box, prepare a flat-head screwdriver and follow the on-screen instructions. The need for replacement of the box does not mean that your printer has ceased to operate in accordance with its specifications. The Epson warranty does not cover the cost of this replacement. It is a user-serviceable part.



**Note:**

- When it is full, you cannot print until the maintenance box is replaced to avoid ink leakage. However, you can perform operations such as saving data to an external USB device.
- When the following screen is displayed, the part cannot be replaced by users. Contact Epson support.



## Replacing Ink Cartridges and Other Consumables

1. Remove the new maintenance box from its package.



**Important:**

*Do not touch the green chip on the side of the maintenance box. Doing so may prevent normal operation and printing.*

**Note:**

*A transparent bag for the used maintenance box is provided with the new maintenance box.*

2. Lift up paper cassette 2 slightly to pull it out.

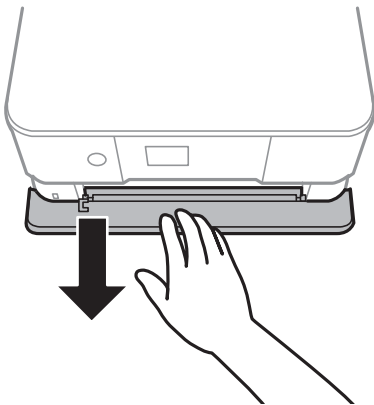

3. Open the control panel.

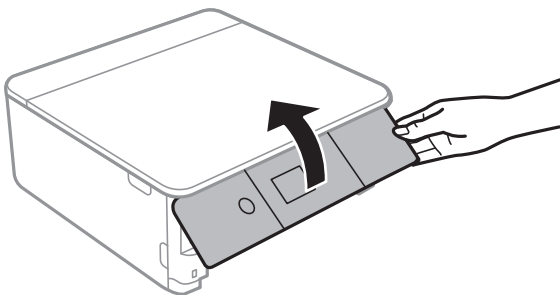

4. Loosen the screw with a flat-head screwdriver, and then remove the cover.

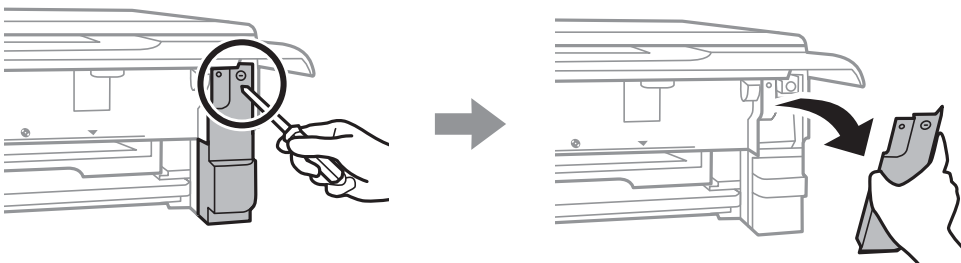

## Replacing Ink Cartridges and Other Consumables

5. Remove the used maintenance box.

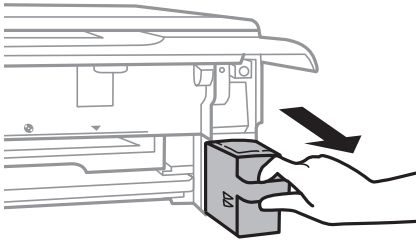

**!** *Important:*

*Do not touch the sections shown in the illustration. Doing so may prevent normal operation and you may get smeared with ink.*

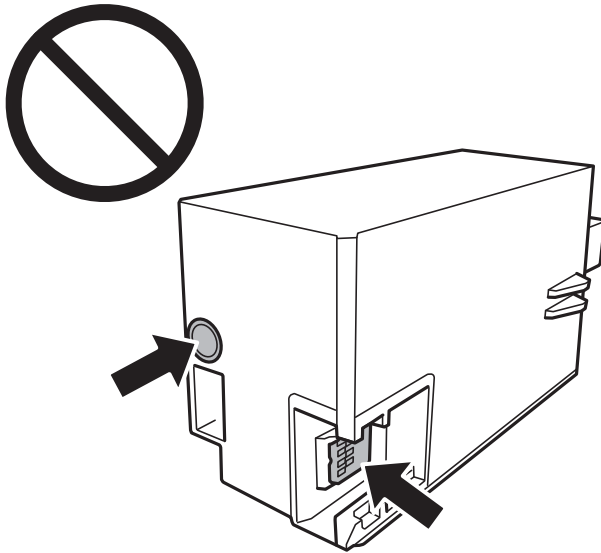

6. Put the used maintenance box in the transparent bag that came with the new maintenance box and seal the bag shut.
7. Insert the new maintenance box all the way into the printer.

## Replacing Ink Cartridges and Other Consumables

8. Reattach the cover.

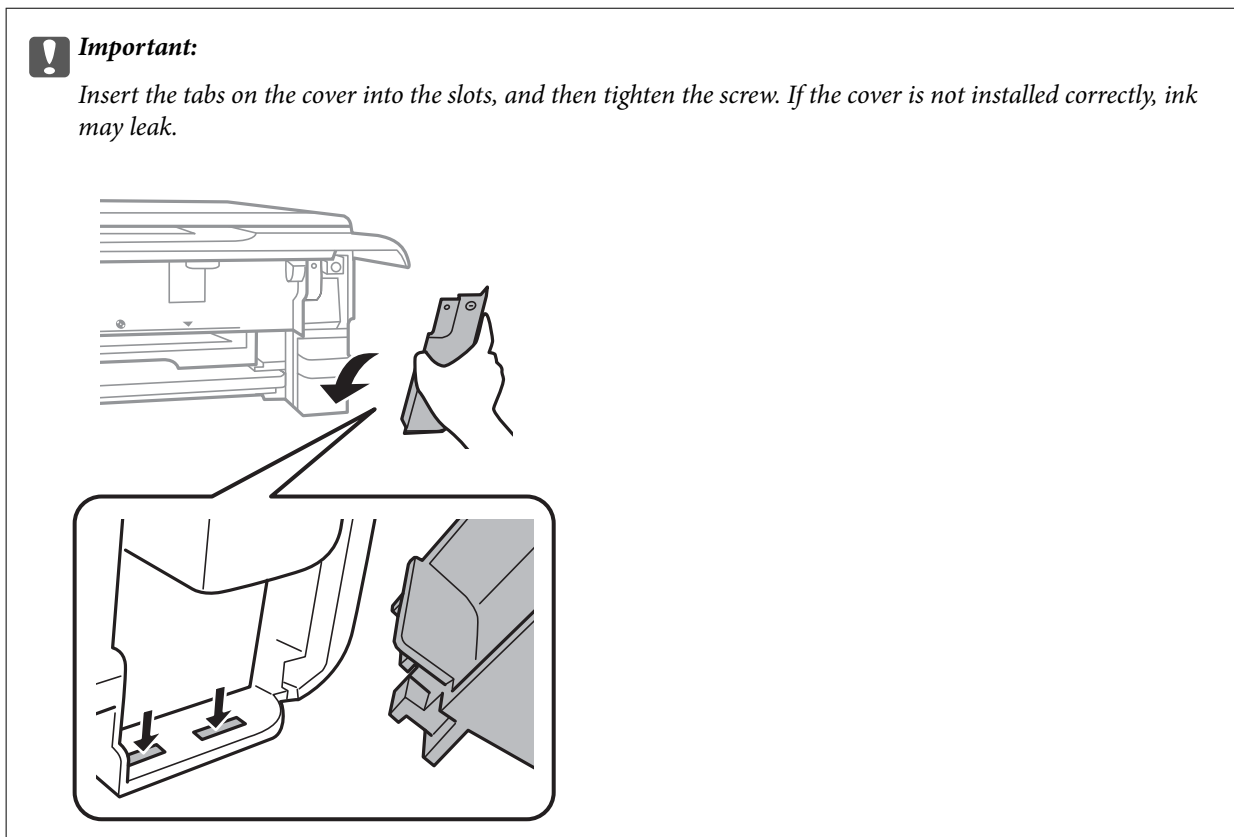

9. Insert paper cassette.

10. Select **Done**.

**!** **Important:**  
*If the maintenance box cannot be recognized, try installing it again. If it is still not recognized, replace the maintenance box. Once a maintenance box has been installed in a printer it cannot be used with other printers.*

### Related Information

- ➔ [“Maintenance Box Code” on page 162](#)
- ➔ [“Maintenance Box Handling Precautions” on page 162](#)

---

## Temporarily Printing with Black Ink

When color ink or photo black ink is expended but black ink still remains while printing from a computer, you can use the following settings to continue printing for a short time using only black ink.

- Type of paper: plain papers, Envelope
- Color: **Grayscale**
- Borderless: Not selected
- EPSON Status Monitor 3: Enabled (for Windows only)

## Replacing Ink Cartridges and Other Consumables

Because this feature is only available for approximately five days, replace the expended ink cartridge as soon as possible.

**Note:**

- ❑ If **EPSON Status Monitor 3** is disabled, access the printer driver, click **Extended Settings** on the **Maintenance** tab, and then select **Enable EPSON Status Monitor 3**.
- ❑ The available period varies depending on the usage conditions.

## Temporarily Printing with Black Ink - Windows

1. When the following window is displayed, cancel printing.

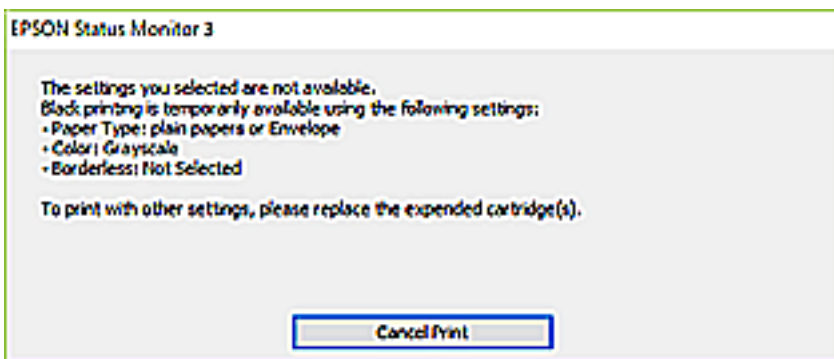
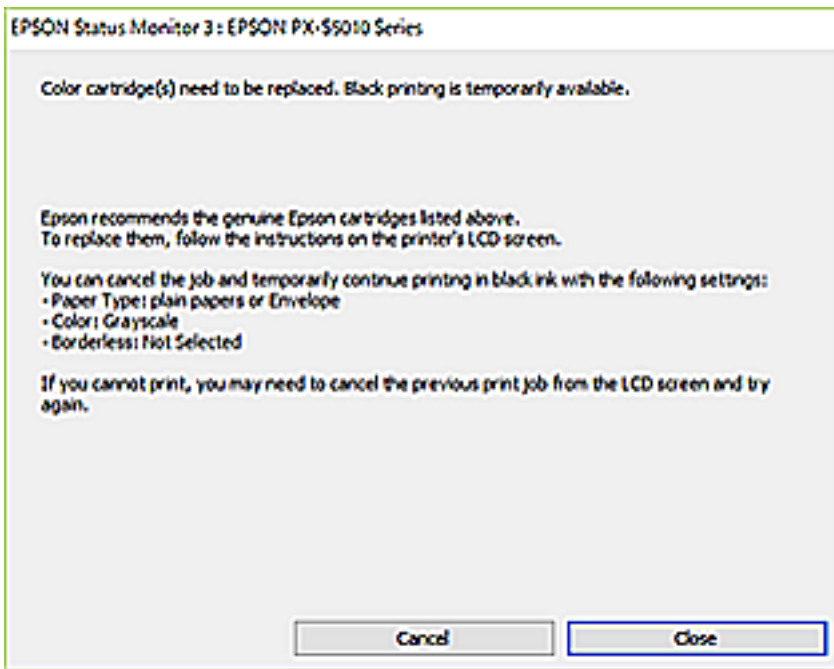

**Note:**

If you cannot cancel printing from the computer, cancel using the printer's control panel.

2. Access the printer driver window.
3. Clear **Borderless** on the **Main** tab.
4. Select **plain papers** or **Envelope** as the **Paper Type** setting on the **Main** tab.

## Replacing Ink Cartridges and Other Consumables

5. Select **Grayscale**.
6. Set the other items on the **Main** and **More Options** tabs as necessary, and then click **OK**.
7. Click **Print**.
8. Click **Print in Black** in the window displayed.

### Related Information

- ➔ [“Loading Paper in the Paper Cassette 1” on page 62](#)
- ➔ [“Loading Paper in the Paper Cassette 2” on page 66](#)
- ➔ [“Printing Basics - Windows” on page 101](#)

## Temporarily Printing with Black Ink - Mac OS

### Note:

To use this feature through a network, connect with **Bonjour**.

1. Click the printer icon in the **Dock**.
2. Cancel the job.

### Note:

If you cannot cancel printing from the computer, cancel using the printer's control panel.

3. Select **System Preferences** from the  menu > **Printers & Scanners** (or **Print & Scan, Print & Fax**), and then select the printer. Click **Options & Supplies** > **Options** (or **Driver**).
4. Select **On** as the **Permit temporary black printing** setting.
5. Access the print dialog.
6. Select **Print Settings** from the pop-up menu.
7. Select any paper size except for a borderless size as the **Paper Size** setting.
8. Select **plain papers** or **Envelope** as the **Media Type** setting.
9. Select **Grayscale**.
10. Set the other items as necessary.
11. Click **Print**.

### Related Information

- ➔ [“Canceling Printing” on page 125](#)
- ➔ [“Loading Paper in the Paper Cassette 1” on page 62](#)
- ➔ [“Loading Paper in the Paper Cassette 2” on page 66](#)
- ➔ [“Printing Basics - Mac OS” on page 103](#)



## Conserving Black Ink when the Black Ink Is Low (for Windows Only)

When black ink is running low and there is enough color ink remaining, you can use a mixture of color inks to create black. You can continue printing while preparing a replacement black ink cartridge.

This feature is only available when you select the following settings in the printer driver.

- Paper Type: **plain papers**
- Quality: **Standard**
- EPSON Status Monitor 3: Enabled

**Note:**

- If **EPSON Status Monitor 3** is disabled, access the printer driver, click **Extended Settings** on the **Maintenance** tab, and then select **Enable EPSON Status Monitor 3**.
- Composite black looks slightly different from pure black. In addition, the print speed is reduced.
- To maintain the quality of the print head, black ink is also consumed.

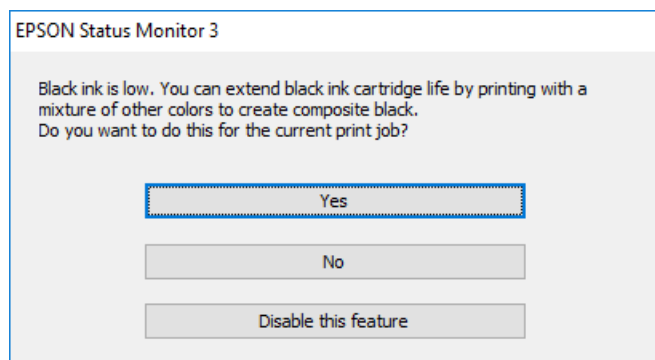

Menu	Descriptions
Yes	Select to use a mixture of color inks and photo black ink to create black. This window is displayed the next time you print a similar job.
No	Select to continue using the remaining black ink. This window is displayed the next time you print a similar job.
Disable this feature	Select to continue using the remaining black ink. This window is not displayed until you replace the black ink cartridge and it runs low again.

# Maintaining the Printer

## Checking and Cleaning the Print Head

If the nozzles are clogged, the printouts become faint, there is visible banding, or unexpected colors appear. When print quality has declined, use the nozzle check feature and check if the nozzles are clogged. If the nozzles are clogged, clean the print head.

### **Important:**

- Do not open the scanner unit or turn off the printer during head cleaning. If the head cleaning is incomplete, you may not be able to print.
- Because print head cleaning uses some ink, clean the print head only if quality declines.
- When ink is low, you may not be able to clean the print head.
- If print quality has not improved after repeating nozzle check and head cleaning about three times, wait for at least six hours without printing, and then run the nozzle check again and repeat the head cleaning if necessary. We recommend to turn off the printer. If print quality has still not improved, contact Epson support.
- To prevent the print head from drying out, do not unplug the printer while the power is on.

## Checking and Cleaning the Print Head - Control Panel

1. Load A4-size plain paper in the paper cassette.

2. Select **Maintenance** on the home screen.

To select an item, move the focus to the item using the ▲ ▼ ◀ ▶ buttons, and then press the OK button.

3. Select **Print Head Nozzle Check**.

4. Follow the on-screen instructions to print the nozzle check pattern.

5. Examine the printed pattern.

- If you cannot see any broken lines or missing segments as in the following "OK" pattern, the nozzles are not clogged. Print head cleaning is not necessary. Select . No further steps are necessary.
- If there are broken lines or missing segments as shown in the "NG" pattern, the print head nozzles may be clogged. Go to the next step.

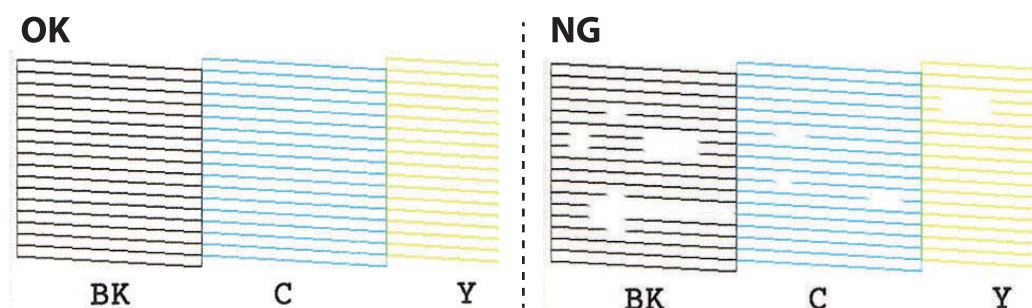

## Maintaining the Printer

6. Select .
7. Follow the on-screen instructions to clean the print head.
8. When cleaning is finished, select **Check**, and then follow the on-screen instructions to print the nozzle check pattern again. Repeat cleaning and printing the pattern until all lines are printed completely.

### Related Information

- ➔ [“Loading Paper in the Paper Cassette 2” on page 66](#)

## Checking and Cleaning the Print Head - Windows

1. Load A4-size plain paper in the paper cassette.
2. Access the printer driver window.
3. Click **Nozzle Check** on the **Maintenance** tab.
4. Follow the on-screen instructions.

### Related Information

- ➔ [“Loading Paper in the Paper Cassette 2” on page 66](#)
- ➔ [“Windows Printer Driver” on page 188](#)

## Checking and Cleaning the Print Head - Mac OS

1. Load A4-size plain paper in the paper cassette.
2. Select **System Preferences** from the  menu > **Printers & Scanners** (or **Print & Scan**, **Print & Fax**), and then select the printer.
3. Click **Options & Supplies** > **Utility** > **Open Printer Utility**.
4. Click **Nozzle Check**.
5. Follow the on-screen instructions.

### Related Information

- ➔ [“Loading Paper in the Paper Cassette 2” on page 66](#)

---

## Aligning the Print Head

If you notice a misalignment of vertical lines or blurred images, align the print head.

## Maintaining the Printer

### Aligning the Print Head - Control Panel

1. Load A4-size plain paper in the paper cassette.
2. Select **Maintenance** on the home screen.  
To select an item, move the focus to the item using the ▲ ▼ ◀ ▶ buttons, and then press the OK button.
3. Select **Print Head Alignment**.
4. Select one of the alignment menus.
  - Vertical Alignment: Select this if your printouts look blurry or vertical ruled lines appear misaligned.
  - Horizontal Alignment: Select this if you see horizontal banding at regular intervals.
5. Follow the on-screen instructions to print an alignment pattern and select the number for the optimum pattern.
  - Vertical Alignment: Find and select the number for the most solid pattern in each group.

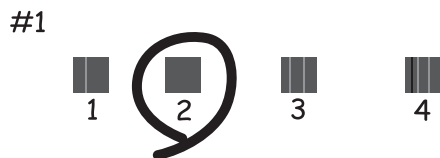

- Horizontal Alignment: Find and select the number for the least separated and overlapping pattern.



#### Related Information

➔ [“Loading Paper in the Paper Cassette 2” on page 66](#)

---

## Cleaning the Paper Path

When the printouts are smeared or scuffed or paper does not feed correctly, clean the roller inside.

## Maintaining the Printer

**!** *Important:*

*Do not use tissue paper to clean the inside of the printer. The print head nozzles may be clogged with lint.*

### Cleaning the Paper Path for Ink Smears

When the printouts are smeared or scuffed, clean the roller inside.

**!** *Important:*

*Do not use tissue paper to clean the inside of the printer. The print head nozzles may be clogged with lint.*

1. Load A4-size plain paper in the paper cassette.

2. Select **Maintenance** on the home screen.

To select an item, move the focus to the item using the ▲▼◀▶ buttons, and then press the OK button.

3. Select **Paper Guide Cleaning**.

4. Follow the on-screen instructions to clean the paper path.

5. Repeat the above procedure until the paper is not smeared with ink.

If the paper still gets dirty with ink even after cleaning several times, go to next step.

6. Turn off the printer by pressing the ⏻ button.

7. Unplug the power cord, and then disconnect the power cord.

8. Raise the control panel as far as it will go so that it is horizontal.

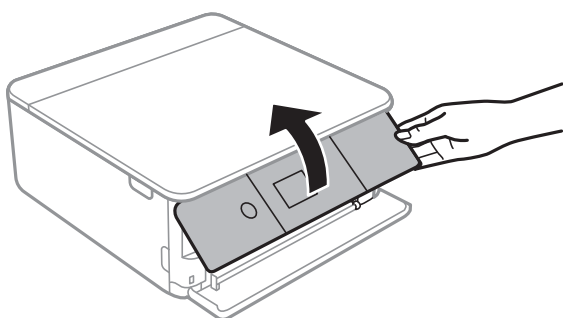

## Maintaining the Printer

- Slide out the output tray.

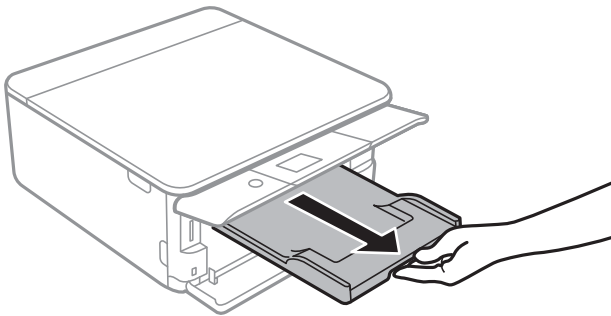

- Gently wipe the two white rollers using a soft, moist cloth.

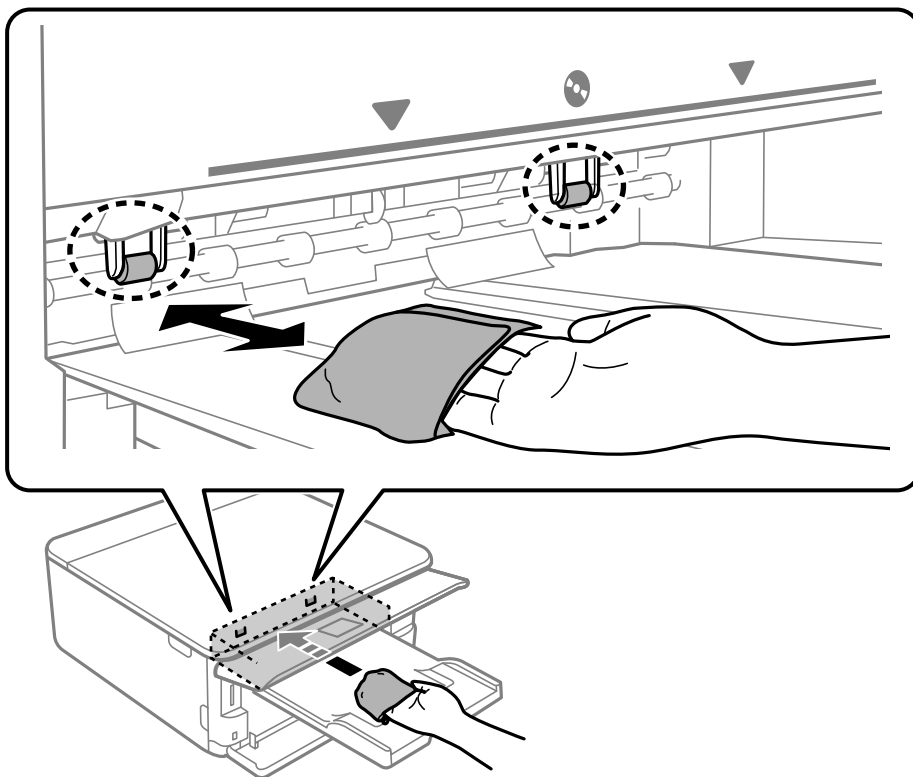

- Connect the power cord.

### Related Information

➔ [“Loading Paper in the Paper Cassette 2” on page 66](#)

## Cleaning the Paper Path for Paper Feeding Problems

When paper is not fed from the paper cassette correctly, clean the roller inside.

- Turn off the printer by pressing the  button.
- Unplug the power cord, and then disconnect the power cord.

## Maintaining the Printer

3. Disconnect the USB cable, and then remove the memory card.
4. Pull out the paper cassettes.  
For paper cassette 2, lift it up slightly, and then pull it out.

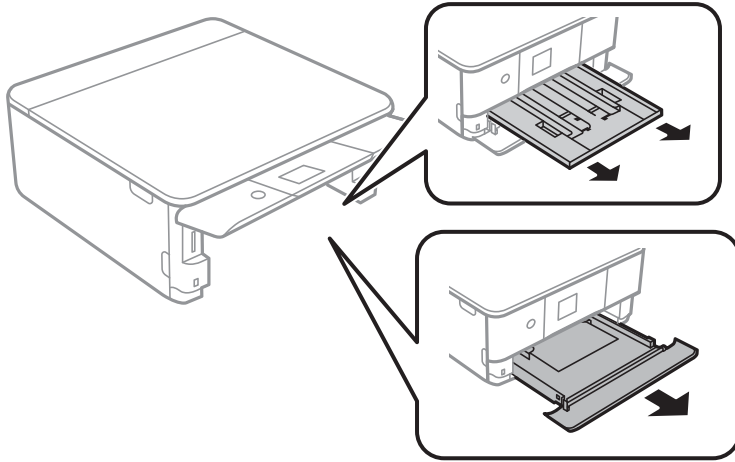

5. Stand the printer with the control panel's  button at the top.

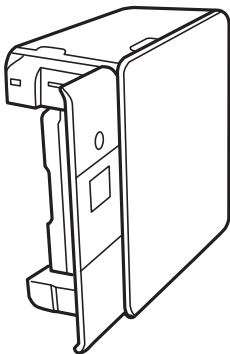

**Caution:**

*Be careful not to trap your hand or fingers when standing the printer. Otherwise you may be injured.*

6. Dampen a cloth with water, wring it out thoroughly, and then wipe the roller while rotating it with the cloth.

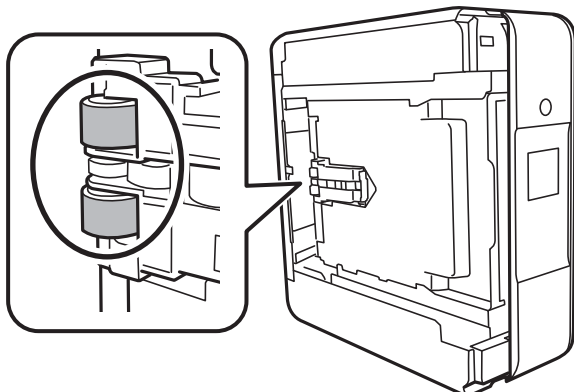

## Maintaining the Printer

- Return the printer to its normal position, and then insert the paper cassettes.

**Important:**

*Do not leave the printer standing for a long time.*

- Connect the power cord.

---

## Cleaning the Scanner Glass

When the copies or scanned images are smeared, clean the scanner glass.

**Important:**

*Never use alcohol or thinner to clean the printer. These chemicals can damage the printer.*

- Open the document cover.

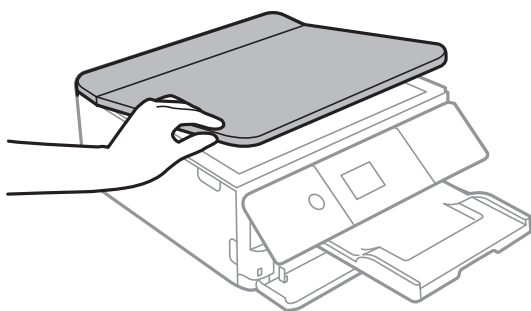

- Use a soft, dry, clean cloth to clean the surface of the scanner glass.

**Important:**

- If the glass surface is stained with grease or some other hard-to-remove material, use a small amount of glass cleaner and a soft cloth to remove it. Wipe off all remaining liquid.
- Do not press the glass surface too hard.
- Be careful not to scratch or damage the surface of the glass. A damaged glass surface can decrease the scan quality.

---

## Cleaning the Translucent Film

When the printout is not improved after aligning the print head or cleaning the paper path, the translucent film inside the printer may be smeared.

Items required:

- Cotton swabs (several)
- Water with a few drops of detergent (2 to 3 drops of detergent in 1/4 cup of tap water)
- Light for checking smears



## Maintaining the Printer

**!** *Important:*

*Do not use cleaning liquid other than water with a few drops of detergent.*

1. Turn off the printer by pressing the  button.
2. Open the scanner unit.

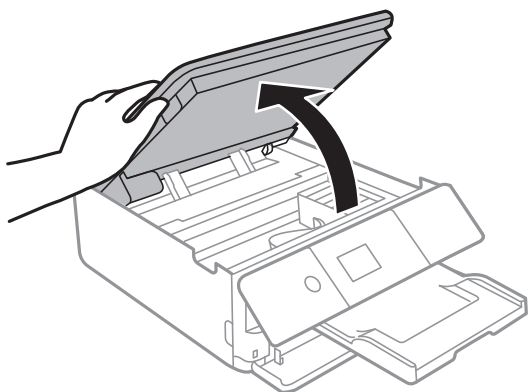

3. Check if the translucent film is smeared. Smears are easier to see if you use a light.  
If there are smears (such as finger marks or grease) on the translucent film (A), go to the next step.

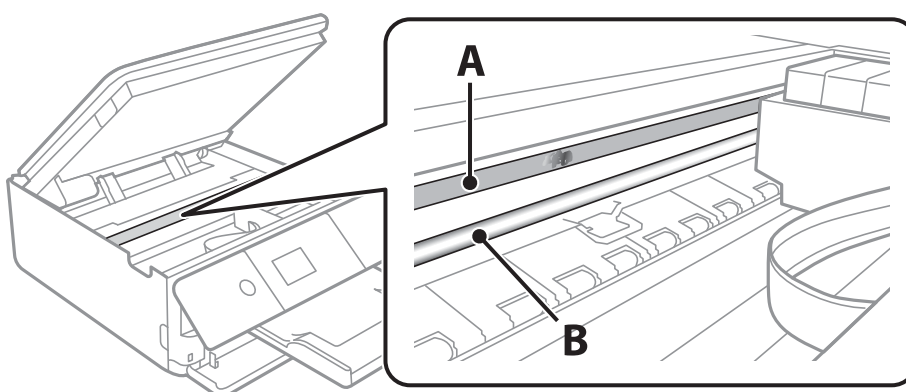

A: Translucent film

B: Rail

**!** *Important:*

*Be careful not to touch the rail (B). Otherwise, you may not be able to print. Do not wipe off the grease on the rail, because this is necessary for operations.*

## Maintaining the Printer

- Moisten a cotton swab with the water with a few drops of detergent so that it is not dripping water, and then wipe the smeared part.

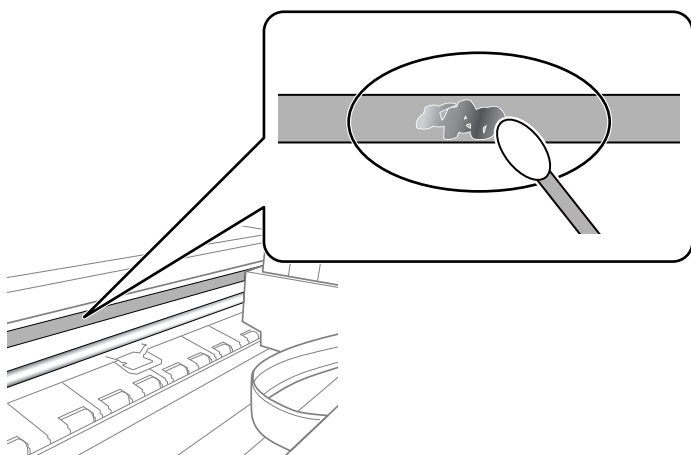

**!** **Important:**

*Wipe off the smear gently. If you press the cotton swab too hard to the film, the springs of the film may be dislocated and the printer may be damaged.*

- Use a new dry cotton swab to wipe the film.

**!** **Important:**

*Do not leave any fibers on the film.*

**Note:**

*To prevent the smear from spreading, frequently replace the cotton swab with a new one.*

- Repeat steps 4 and 5 until the film is not smeared.
- Visually check that the film is not smeared.

---

## Saving Power

The printer enters sleep mode or turns off automatically if no operations are performed for a set period. You can adjust the time before power management is applied. Any increase will affect the product's energy efficiency. Please consider the environment before making any change.

Depending on the location of purchase, the printer may have a feature that turns it off automatically if it is not connected to the network for 30 minutes.

### Saving Power - Control Panel

- Select **Settings** on the home screen.

To select an item, move the focus to the item using the ▲ ▼ ◀ ▶ buttons, and then press the OK button.

- Select **Basic Settings**.

## Maintaining the Printer

3. Do one of the following.
  - Select **Sleep Timer** or **Power Off Settings** > **Power Off If Inactive** or **Power Off If Disconnected**, and then make settings.
  - Select **Sleep Timer** or **Power Off Timer**, and then make settings.

**Note:**

*Your product may have the **Power Off Settings** or **Power Off Timer** feature depending on the location of purchase.*

# Menu Options for Settings

Select **Settings** on the home screen of the printer to make various settings.



---

## Menu Options for Supply Status

Select the menu on the control panel as described below.

### Settings > Supply Status

Displays the approximate level of the ink and service life of the maintenance box.

When  is displayed, ink is running low or the maintenance box is nearly full. When  is displayed, you need to replace the item as ink is expended or the maintenance box is full.

You can replace ink cartridges or print supply status information from this screen.

### Related Information

➔ [“Replacing Ink Cartridges” on page 158](#)

---

## Menu Options for Basic Settings

Select the menus on the control panel as described below.

### Settings > Basic Settings

#### Screen Saver:

Select **Memory Card Data** to display photos as a slideshow when no operations are performed for about three minutes.

#### LCD Brightness:

Adjust the brightness of the LCD screen.

#### Auto Power On:

Select **On** to turn on the printer automatically when it receives a print or scan job over a USB-connection or a network connection. To start printing, you need to slide out the output tray. Also, enabling **Auto Power On** increases power consumption slightly in standby status when compared to turning the printer off completely.

Use the **Power Off Timer** setting if you want the printer to automatically turn off when the print or scan job is finished and a set time period has passed with no operations performed. This is useful when printing from a remote location such as over the Internet.

#### Power Off Timer:

Your product may have this feature or the **Power Off Settings** feature depending on the location of purchase.

## Menu Options for Settings

Select this setting to turn the printer off automatically when it is not used for a specified period of time. You can adjust the time before power management is applied. Any increase will affect the product's energy efficiency. Please consider the environment before making any change.

### Power Off Settings:

Your product may have this feature or the **Power Off Timer** feature depending on the location of purchase.

#### Power Off If Inactive

Select this setting to turn the printer off automatically if it is not used for a specified period of time. Any increase will affect the product's energy efficiency. Please consider the environment before making any change.

#### Power Off If Disconnected

Select this setting to turn the printer off after 30 minutes when all ports including the USB port are disconnected. This feature may not be available depending on your region.

### Sleep Timer:

Adjust the time period to enter a sleep mode (energy saving mode) when the printer has not performed any operations. The LCD screen turns black when the setting time passes.

### Language:

Select the language used on the LCD screen.

### Clear All Settings:

Resets the **Basic Settings** to their defaults.

### Related Information

➔ ["Saving Power" on page 178](#)

---

## Menu Options for Printer Settings

Select the menus on the control panel as described below.

### Settings > Printer Settings

#### Paper Source Setting:

##### Paper Setup:

Select the paper size and paper type you loaded in the paper source. You can make **Favorite Paper Settings** in paper size and paper type.

##### Paper Configuration:

Select **On** to display the paper settings screen automatically by referring to **Settings > Printer Settings > Paper Source Setting > Paper Setup** when paper is loaded in the paper source. If you disable this feature, you cannot print from an iPhone or iPad using AirPrint

#### CD/DVD:

Adjusts the printing position of a CD/DVD by moving up, down, left, or right to fit.

## Menu Options for Settings

### CD Inner/Outer:

Adjusts the printing position of the inner and outer diameters of a CD/DVD. Up to 120 mm for the outer diameter, and a minimum of 18 mm for the inner diameter can be specified. Depending on the setting, the CD/DVD or CD/DVD tray may get dirty. Set the range to fit the printable area of your CD/DVD. The print area set here is the initial value when printing photos from a memory card onto a CD/DVD.

### Stickers:

Adjusts the printing position of a photo sticker by moving up, down, left, or right to fit.

### Thick Paper:

Select **On** to prevent ink from smearing on your printouts, however, this may lower the print speed.

### Quiet Mode:

Select **On** to reduce noise during printing, however, this may lower the print speed. Depending on the paper type and print quality settings you selected, there may be no difference in the printer's noise level.

### Ink Drying Time:

Select the ink drying time you want to use when performing 2-sided printing. The printer prints the other side after printing one side. If your printout is smeared, increase the time setting.

### Bidirectional:

Select **On** to change the print direction; Prints while the print head moves to the left and to the right. If vertical or horizontal ruled lines on your printout look blurred or misaligned, disabling this feature may solve the problem; however, doing so may reduce print speed.

### Clear All Settings

Resets the **Printer Settings** to their defaults.

---

## Menu Options for Network Settings

Select the menus on the control panel as described below.

### Settings > Network Settings

#### Wi-Fi Setup:

Set up or change wireless network settings. Choose the connection method from following and then follow the instructions on the control panel.

- Wi-Fi (Recommended):
- Wi-Fi Direct

#### Network Status:

Displays the current network connections.

- Wi-Fi Status
- Wi-Fi Direct Status
- Print Status Sheet

## Menu Options for Settings

### Connection Check:

Checks the current network connection and prints the report. If there are any problems with the connection, see the report to solve the problem.

### Advanced:

Make the following detailed settings.

- Device Name
- TCP/IP
- Proxy Server

### Related Information

- ➔ “Making Wi-Fi Settings by Entering the SSID and Password” on page 38
- ➔ “Making Wi-Fi Settings by Push Button Setup (WPS)” on page 39
- ➔ “Making Wi-Fi Settings by PIN Code Setup (WPS)” on page 41
- ➔ “Making Wi-Fi Direct (Simple AP) Connection Settings” on page 42
- ➔ “Checking the Network Connection Status” on page 44
- ➔ “Making Advanced Network Settings” on page 43

---

## Menu Options for Web Service Settings

Select the menus on the control panel as described below.

### Settings > Web Service Settings

#### Epson Connect Services:

Displays whether the printer is registered and connected to Epson Connect. You can register to the service by selecting **Register** and follow the instructions. When you have registered, you can change the following settings.

- Suspend/Resume
- Unregister

For details, see the following web site.

<https://www.epsonconnect.com/>

<http://www.epsonconnect.eu> (Europe only)

#### Google Cloud Print Services:

Displays whether the printer is registered and connected to Google Cloud Print services. When you have registered, you can change the following settings.

- Enable/Disable
- Unregister

For details on registering to Google Cloud Print services, see the following web site.

<https://www.epsonconnect.com/>

<http://www.epsonconnect.eu> (Europe only)

## Menu Options for Settings

### Related Information

➔ [“Epson Connect Service” on page 186](#)

---

## Menu Options for File Sharing Setup

Select the menus on the control panel as described below.

### Settings > File Sharing Setup

Select the connection method between the printer and a computer that will have write access to the memory card inserted in the printer. Read and write access is given to the computer with the priority connection. Only read access is given to other computers.

### Related Information

➔ [“Accessing a Memory Card From a Computer” on page 248](#)

---

## Menu Options for Camera Print Settings

Select the menus on the control panel as described below.

### Settings > Camera Print Settings

Make settings when printing from a digital camera.

### Related Information

➔ [“Menu Options for Paper and Print Settings” on page 88](#)

➔ [“Menu Options for Editing Photos” on page 89](#)

---

## Menu Options for Guide Functions

Select the menus on the control panel as described below.

### Settings > Guide Functions

#### Paper Mismatch:

Displays a warning if the paper settings (print settings) for the print job do not match the printer's paper settings made when you loaded the paper. This setting prevents misprinting. However, the paper setting screen is not displayed when **Paper Configuration** is disabled in the following menus.

#### Settings > Printer Settings > Paper Source Setting

#### Auto Selection Mode:

When any of the following operations are performed, the menus appropriate to the operation are displayed.

- A memory card is inserted.



## Menu Options for Settings

A USB memory is inserted.

All settings:

Enables or disables all guidance functions.

Clear All Settings:

Resets the **Guide Functions** settings to their defaults.

---

## Menu Options for Firmware Update

Select the menus on the control panel as described below.

### Settings > Firmware Update

Update:

Check if the latest version of the firmware has been uploaded to the network server. If an update is available, you can select whether or not to start updating.

Notification:

Select **On** to receive a notification if a firmware update is available.

### Related Information

➔ [“Software Update Tools \(EPSON Software Updater\)” on page 198](#)

---

## Menu Options for Restore Default Settings

Select the menus on the control panel as described below.

### Settings > Restore Default Settings

Network Settings:

Resets the network settings to their defaults.

All Except Network Settings:

Resets all settings except for network settings to their defaults.

All Settings:

Resets all settings to their defaults.

# Network Service and Software Information

This section introduces the network services and software products available for your printer from the Epson website or the supplied software disc.

---

## Epson Connect Service

By using Epson Connect service available on the Internet, you can print from your smartphone, tablet PC, or laptop, anytime and practically anywhere.

The features available on the Internet are as follows.

Email Print	Epson iPrint remote print	Scan to Cloud	Remote Print Driver
✓	✓	✓	✓

See the Epson Connect portal website for details.

<https://www.epsonconnect.com/>

<http://www.epsonconnect.eu> (Europe only)

## Registering to Epson Connect Service from the Control Panel

Follow the steps below to register the printer.

1. Select **Settings** on the home screen.

To select an item, move the focus to the item using the ▲ ▼ ◀ ▶ buttons, and then press the OK button.

2. Select **Web Service Settings > Epson Connect Services > Register > Start Setup** on the home screen to print the registration sheet.
3. Follow the instructions on the registration sheet to register the printer.

---

## Application for Configuring Printer Operations (Web Config)

Web Config is an application that runs in a web browser, such as Internet Explorer and Safari, on a computer or smart device. You can confirm the printer status or change the network service and printer settings. To use the Web Config, connect the printer and the computer or device to the same network.

The following browsers are supported.

## Network Service and Software Information

OS	Browser
Windows XP SP3 or later	Microsoft Edge, Internet Explorer 8 or later, Firefox*, Chrome*
Mac OS X v10.6.8 or later	Safari*, Firefox*, Chrome*
iOS*	Safari*
Android 2.3 or later	Default browser
Chrome OS*	Default browser

\* Use the latest version.

## Running Web Config on a Web Browser

1. Check the printer's IP address.

Select the network icon on the printer's home screen, and then select the active connection method to confirm the printer's IP address.

To select an item, move the focus to the item using the ▲ ▼ ◀ ▶ buttons, and then press the OK button.

**Note:**

*You can also check the IP address by printing the network connection report.*

2. Launch a Web browser from a computer or smart device, and then enter the printer's IP address.

Format:

IPv4: http://the printer's IP address/

IPv6: http://[the printer's IP address]/

Examples:

IPv4: http://192.168.100.201/

IPv6: http://[2001:db8::1000:1]/

**Note:**

*Using the smart device, you can also run Web Config from the maintenance screen of Epson iPrint.*

### Related Information

- ➔ [“Using Epson iPrint” on page 120](#)
- ➔ [“Printing a Network Connection Report” on page 45](#)

## Running Web Config on Windows

When connecting a computer to the printer using WSD, follow the steps below to run Web Config.

1. Open the printer list on the computer.

- Windows 10

Click on the start button, and then select **Windows System > Control Panel > View devices and printers in Hardware and Sound**.

## Network Service and Software Information

Windows 8.1/Windows 8

Select **Desktop > Settings > Control Panel > View devices and printers in Hardware and Sound (or Hardware)**.

Windows 7

Click the start button, and select **Control Panel > View devices and printers in Hardware and Sound**.

Windows Vista

Click the start button, and select **Control Panel > Printers in Hardware and Sound**.

2. Right-click on your printer and select **Properties**.

3. Select the **Web Service** tab and click the URL.

## Running Web Config on Mac OS

1. Select **System Preferences** from the  menu > **Printers & Scanners** (or **Print & Scan, Print & Fax**), and then select the printer.

2. Click **Options & Supplies > Show Printer Webpage**.

---

## Windows Printer Driver

The printer driver controls the printer according to the commands from an application. Making settings on the printer driver provides the best printing results. You can also check the status of the printer or keep it in top operating condition using the printer driver utility.

**Note:**

You can change the language of the printer driver. Select the language you want to use from the **Language** setting on the **Maintenance** tab.

### Accessing the printer driver from applications

To make settings that apply only to the application you are using, access from that application.

Select **Print** or **Print Setup** from the **File** menu. Select your printer, and then click **Preferences** or **Properties**.

**Note:**

Operations differ depending on the application. See the application's help for details.

### Accessing the printer driver from the control panel

To make settings that apply to all of the applications, access from the control panel.

Windows 10

Click on the start button, and then select **Windows System > Control Panel > View devices and printers in Hardware and Sound**. Right-click on your printer, or press and hold it and then select **Printing preferences**

Windows 8.1/Windows 8

Select **Desktop > Settings > Control Panel > View devices and printers in Hardware and Sound**. Right-click on your printer, or press and hold it and then select **Printing preferences**.

## Network Service and Software Information

### ❑ Windows 7

Click the start button, and select **Control Panel > View devices and printers** in **Hardware and Sound**. Right-click on your printer and select **Printing preferences**.

### ❑ Windows Vista

Click the start button, and select **Control Panel > Printers** in **Hardware and Sound**. Right-click on your printer and select **Select printing preferences**.

### ❑ Windows XP

Click the start button, and select **Control Panel > Printers and Other Hardware > Printers and Faxes**. Right-click on your printer and select **Printing preferences**.

### Accessing the printer driver from the printer icon on the task bar

The printer icon on the desktop task bar is a shortcut icon allowing you to quickly access the printer driver.

If you click the printer icon and select **Printer Settings**, you can access the same printer settings window as the one displayed from the control panel. If you double-click this icon, you can check the status of the printer.

#### **Note:**

*If the printer icon is not displayed on the task bar, access the printer driver window, click **Monitoring Preferences** on the **Maintenance** tab, and then select **Register the shortcut icon to the taskbar**.*

### Starting the utility

Access the printer driver window. Click the **Maintenance** tab.

### Related Information

➔ [“Guide to Windows Printer Driver” on page 189](#)

## Guide to Windows Printer Driver

Help is available in the printer driver for Windows. To view explanations of the setting items, right-click on each item, and then click **Help**.

### Main Tab

You can make basic settings for printing, such as paper type or paper size.

## Network Service and Software Information

You can also make settings for printing both sides of the paper or printing multiple pages on one sheet.

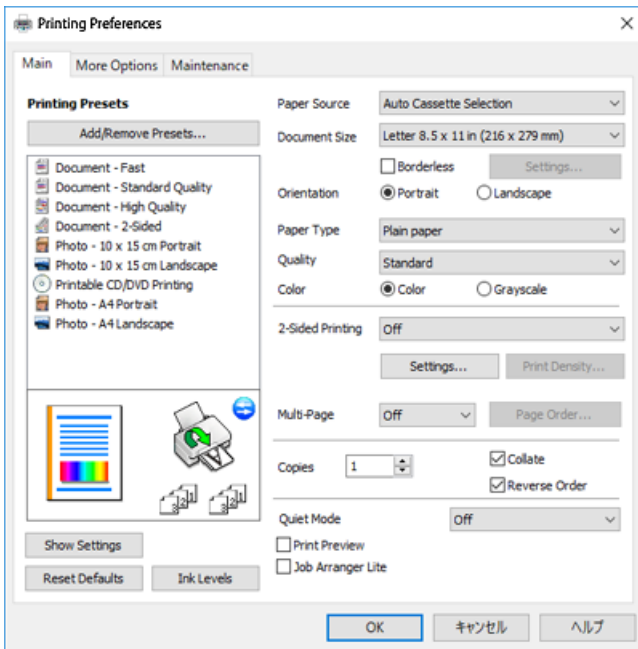

### More Options Tab

You can select additional layout and printing options such as changing the size of a printout or making color corrections.

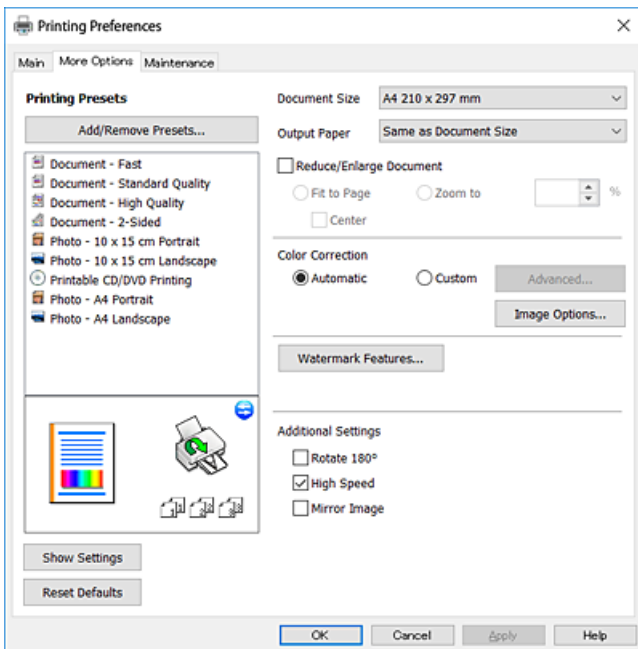

## Network Service and Software Information

### Maintenance Tab

You can run maintenance features such as nozzle check and print head cleaning, and by starting **EPSON Status Monitor 3**, you can check printer status and error information.

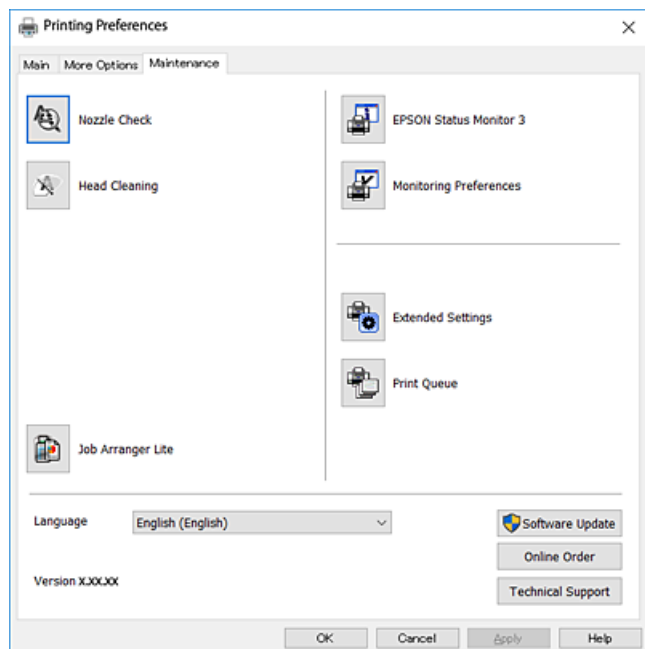

## Making Operation Settings for the Windows Printer Driver

You can make settings such as enabling **EPSON Status Monitor 3**.

1. Access the printer driver window.
2. Click **Extended Settings** on the **Maintenance** tab.
3. Make the appropriate settings, and then click **OK**.  
See the online help for explanations of the setting items.

### Related Information

➔ [“Windows Printer Driver” on page 188](#)

---

## Mac OS Printer Driver

The printer driver controls the printer according to the commands from an application. Making settings on the printer driver provides the best printing results. You can also check the status of the printer or keep it in top operating condition using the printer driver utility.

### Accessing the printer driver from applications

Click **Page Setup** or **Print** on the **File** menu of your application. If necessary, click **Show Details** (or ▼) to expand the print window.

## Network Service and Software Information

**Note:**

Depending on the application being used, **Page Setup** may not be displayed in the **File** menu, and the operations for displaying the print screen may differ. See the application's help for details.

### Starting the utility

Select **System Preferences** from the  menu > **Printers & Scanners** (or **Print & Scan**, **Print & Fax**), and then select the printer. Click **Options & Supplies** > **Utility** > **Open Printer Utility**.

### Related Information

➔ [“Guide to Mac OS Printer Driver” on page 192](#)

## Guide to Mac OS Printer Driver

### Print dialog

Switch the pop-up menu on the center of the screen to show more items.

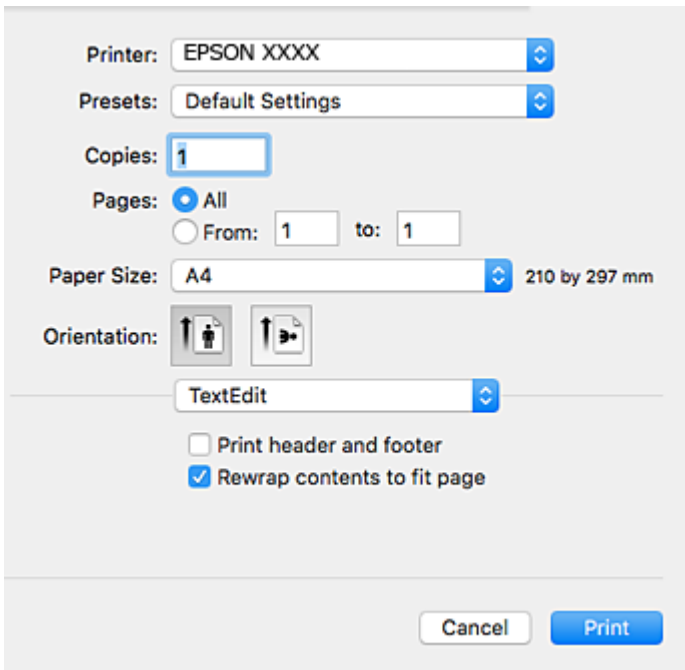

Pop-up Menu	Descriptions
Layout	You can select a layout for printing several pages on one sheet or select to print a border.
Color Matching	You can adjust the colors.
Paper Handling	You can reduce or enlarge the size of the print job to automatically fit the paper size you loaded.
Cover Page	You can select a cover for your documents. Select <b>Cover Page Type</b> to set the contents to be printed on the cover.
Print Settings	You can make the basic print settings such as paper type and print quality.



## Network Service and Software Information

Pop-up Menu	Descriptions
Color Options	When you select <b>EPSON Color Controls</b> from the <b>Color Matching</b> menu, you can select a color correction method.
Two-sided Printing Settings	You can select a binding direction for 2-sided printing or select a document type.

**Note:**

On OS X Mountain Lion or later, if **Print Settings** menu is not displayed, Epson printer driver has not been installed correctly.

Select **System Preferences** from the  menu > **Printers & Scanners** (or **Print & Scan**, **Print & Fax**), remove the printer, and then add the printer again. Access the following website, and then enter the product name. Go to **Support**, and then see **Tips**.

<http://epson.sn>

### Epson Printer Utility

You can run a maintenance feature such as nozzle check and print head cleaning, and by starting **EPSON Status Monitor**, you can check printer status and error information.

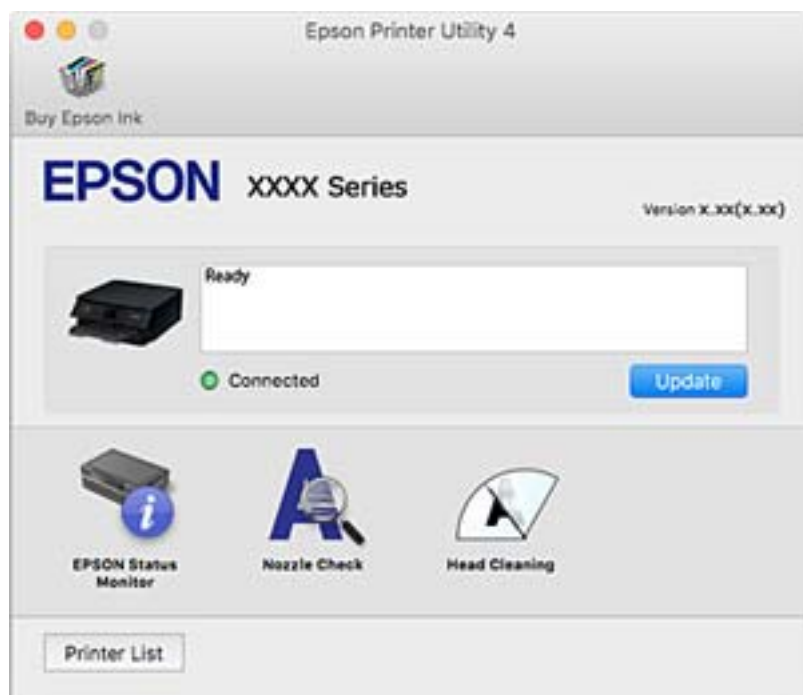

## Making Operation Settings for the Mac OS Printer Driver

### Accessing the Operation Settings Window of the Mac OS Printer Driver

Select **System Preferences** from the  menu > **Printers & Scanners** (or **Print & Scan**, **Print & Fax**), and then select the printer. Click **Options & Supplies** > **Options** (or **Driver**).

## Operation Settings of the Mac OS Printer Driver

- Thick paper and envelopes: Prevents the ink from smearing when printing on thick paper. However, this may reduce print speed.
- Skip Blank Page: Avoids printing blank pages.
- Quiet Mode: Reduces the noise the printer makes, however, may reduce print speed.
- Permit temporary black printing: Prints only with black ink temporarily.
- Automatic Cassette Switching: Automatically feeds paper from paper cassette 2 when paper run out in paper cassette 1. Load the same paper (type and size) in paper cassette 1 and paper cassette 2.
- High Speed Printing: Prints when the print head moves in both directions. The print speed is faster, but the quality may decline.
- Warning Notifications: Allows the printer driver to display warning notifications.
- Establish bidirectional communication : Usually, this should be set to **On**. Select **Off** when acquiring the printer information is impossible because the printer is shared with Windows computers on a network or for any other reason.

### Related Information

➔ [“Temporarily Printing with Black Ink” on page 166](#)

---

## Application for Scanning Documents and Images (Epson Scan 2)

Epson Scan 2 is an application for controlling scanning. You can adjust the size, resolution, brightness, contrast, and quality of the scanned image. You can also start Epson Scan 2 from a TWAIN-compliant scanning application. See the application's help for details.

### Starting on Windows

- Windows 10  
Click the start button, and then select **EPSON > Epson Scan 2**.
- Windows 8.1/Windows 8  
Enter the application name in the search charm, and then select the displayed icon.
- Windows 7/Windows Vista/Windows XP  
Click the start button, and then select **All Programs** or **Programs > EPSON > Epson Scan 2 > Epson Scan 2**.

### Starting on Mac OS

#### Note:

*Epson Scan 2 does not support the Mac OS fast user switching feature. Turn off fast user switching.*

Select **Go > Applications > Epson Software > Epson Scan 2**.

### Related Information

➔ [“Installing Applications” on page 198](#)

## Adding the Network Scanner

Before using Epson Scan 2, you need to add the network scanner.

1. Start the software, and then click **Add** on the **Scanner Settings** screen.

**Note:**

- If **Add** is grayed out, click **Enable Editing**.
- If the main screen of Epson Scan 2 is displayed, it has already been connected to the scanner. If you want to connect to another network, select **Scanner** > **Settings** to open the **Scanner Settings** screen.

2. Add the network scanner. Enter the following items, and then click **Add**.

- Model:** Select the scanner you want to connect to.
- Name:** Enter the scanner name within 32 characters.
- Search for Network:** When the computer and the scanner are on the same network, the IP address is displayed. If it is not displayed, click the  button. If the IP address is still not displayed, click **Enter address**, and then enter the IP address directly.

3. Select the scanner on the **Scanner Settings** screen, and then click **OK**.

---

## Application for Configuring Scanning Operations from the Control Panel (Epson Event Manager)

Epson Event Manager is an application that allows you to manage scanning from the control panel and save images to a computer. You can add your own settings as presets, such as the document type, the save folder location, and the image format. See the application's help for details.

### Starting on Windows

- Windows 10

Click the start button, and then select **Epson Software** > **Event Manager**.

- Windows 8.1/Windows 8

Enter the application name in the search charm, and then select the displayed icon.

- Windows 7/Windows Vista/Windows XP

Click the start button, and then select **All Programs** or **Programs** > **Epson Software** > **Event Manager**.

### Starting on Mac OS

**Go** > **Applications** > **Epson Software** > **Event Manager**.

### Related Information

- ➔ [“Scanning to a Computer” on page 137](#)
- ➔ [“Installing Applications” on page 198](#)

---

## Application for Laying Out Photos (Epson Easy Photo Print)

Epson Easy Photo Print is an application that allows you to easily print photos with various layouts. You can preview the photo image and adjust the images or position. You can also print photos with a frame. See the application's help for details.

By printing on genuine Epson photo paper, the ink quality is maximized and the printouts are vivid and clear.

To perform borderless printing using a commercially available application, make the following settings.

- Create image data to fit the paper size. If a margin setting is available in the application you are using, set the margin to 0 mm.
- Enable the borderless printing setting in the printer driver.

**Note:**

*To use this application, the printer driver needs to be installed.*

### Starting on Windows

- Windows 10

Click the start button, and then select **Epson Software > Epson Easy Photo Print**.

- Windows 8.1/Windows 8

Enter the application name in the search charm, and then select the displayed icon.

- Windows 7/Windows Vista/Windows XP

Click the start button, and then select **All Programs** or **Programs > Epson Software > Epson Easy Photo Print**.

### Starting on Mac OS

**Go > Applications > Epson Software > Epson Easy Photo Print**.

### Related Information

➔ [“Installing Applications” on page 198](#)

---

## Application for Printing Text or Images on a Disc (Epson Print CD)

Epson Print CD is an application that allows you to design a CD/DVD label to be printed directly onto a CD/DVD. You can also print a CD/DVD jacket for CD/DVD case. See the application's help for details.

**Note:**

*To use this application, the printer driver needs to be installed.*

### Starting on Windows

- Windows 10

Click the start button, and then select **Epson Software > Print CD**.

## Network Service and Software Information

### Windows 8/Windows 8.1

Enter the application name in the search charm, and then select the displayed icon.

### Windows 7/Windows Vista/Windows XP

Click the start button, and then select **All Programs** or **Programs > Epson Software > Print CD**.

### Starting on Mac OS

Select **Go > Applications > Epson Software > Print CD > Print CD**.

### Related Information

➔ [“Installing Applications” on page 198](#)

---

## Application for Printing Web Pages (E-Web Print)

E-Web Print is an application that allows you to easily print web pages with various layouts. See the application's help for details. You can access the help from the **E-Web Print** menu on the **E-Web Print** tool bar.

### Note:

*Mac OS is not supported.*

*Check for supported browsers and the latest version from the download site.*

### Starting

When you install E-Web Print, it is displayed in your browser. Click **Print** or **Clip**.

### Related Information

➔ [“Installing Applications” on page 198](#)

---

## Application for Scanning and Transferring Images (Easy Photo Scan)

Easy Photo Scan is an application that allows you to scan photos and easily send the scanned image to a computer or cloud service. You can also easily adjust the scanned image. See the application's help for details.

### Note:

*To use this application, the scanner driver Epson Scan 2 needs to be installed.*

### Starting on Windows

#### Windows 10

Click the start button, and then select **Epson Software > Easy Photo Scan**.

#### Windows 8.1/Windows 8

Enter the application name in the search charm, and then select the displayed icon.

#### Windows 7/Windows Vista/Windows XP

Click the start button, and then select **All Programs** or **Programs > Epson Software > Easy Photo Scan**.

## Network Service and Software Information

### Starting on Mac OS

Select **Go > Applications > Epson Software > Easy Photo Scan**.

### Related Information

➔ [“Installing Applications” on page 198](#)

---

## Software Update Tools (EPSON Software Updater)

EPSON Software Updater is an application that checks for new or updated software on the internet and installs it. You can also update the printer's firmware and manual.

### Starting on Windows

Windows 10

Click the start button, and then select **Epson Software > EPSON Software Updater**.

Windows 8.1/Windows 8

Enter the application name in the search charm, and then select the displayed icon.

Windows 7/Windows Vista/Windows XP

Click the start button, and then select **All Programs** or **Programs > Epson Software > EPSON Software Updater**.

#### **Note:**

*You can also start EPSON Software Updater by clicking the printer icon on the task bar on the desktop, and then selecting **Software Update**.*

### Starting on Mac OS

Select **Go > Applications > Epson Software > EPSON Software Updater**.

### Related Information

➔ [“Installing Applications” on page 198](#)

---

## Installing Applications

Connect your computer to the network and install the latest version of applications from the website.

#### **Note:**

*Log on to your computer as an administrator. Enter the administrator password if the computer prompts you.*

*When reinstalling an application, you need to uninstall it first.*

1. Quit all running applications.
2. When installing the printer driver or Epson Scan 2, disconnect the printer and the computer temporarily.

#### **Note:**

*Do not connect the printer and the computer until you are instructed to do so.*

## Network Service and Software Information

3. Access to the following website, and then enter the product name.

<http://epson.sn>

4. Select **Setup**, and then click **Download**.
5. Click or double-click the downloaded file, and then follow the on-screen instructions.

**Note:**

*If you are using a Windows computer and you cannot download applications from the website, install them from the software disc that came with the printer.*

### Related Information

- ➔ [“Uninstalling Applications” on page 200](#)

---

## Updating Applications and Firmware

You may be able to clear certain problems and improve or add functions by updating the applications and the firmware. Make sure you use the latest version of the applications and firmware.

1. Make sure that the printer and the computer are connected, and the computer is connected to the internet.
2. Start EPSON Software Updater, and update the applications or the firmware.



**Important:**

*Do not turn off the computer or the printer until the update is complete; otherwise, the printer may malfunction.*

**Note:**

*If you cannot find the application you want to update in the list, you cannot update using the EPSON Software Updater. Check for the latest versions of the applications from your local Epson website.*

<http://www.epson.com>

### Related Information

- ➔ [“Software Update Tools \(EPSON Software Updater\)” on page 198](#)

## Updating the Printer's Firmware using the Control Panel

If the printer is connected to the Internet, you can update the printer's firmware using the control panel. By updating the firmware, the printer's performance may improve, or new functions may be added. You can also set the printer to regularly check for firmware updates and notify you if any are available.

1. Select **Settings** on the home screen.
2. Select **Firmware Update > Update**.

**Note:**

*Enable **Notification** to set the printer to regularly check for available firmware updates.*

3. Check the message displayed on the screen and press the OK button to start searching for available updates.

## Network Service and Software Information

4. If a message is displayed on the LCD screen informing you that a firmware update is available, follow the on-screen instructions to start the update.

**Important:**

- Do not turn off or unplug the printer until the update is complete; otherwise, the printer may malfunction.
- If the firmware update is not completed or is unsuccessful, the printer does not start up normally and "Recovery Mode" is displayed on the LCD screen the next time the printer is turned on. In this situation, you need to update the firmware again using a computer. Connect the printer to the computer with a USB cable. While "Recovery Mode" is displayed on the printer, you cannot update the firmware over a network connection. On the computer, access your local Epson website, and then download the latest printer firmware. See the instructions on the website for the next steps.

---

## Uninstalling Applications

Log in to your computer as an administrator. Enter the administrator password if the computer prompts you.

### Uninstalling Applications - Windows

1. Press the  button to turn off the printer.
2. Quit all running applications.
3. Open **Control Panel**:
  - Windows 10  
Click on the start button, and then select **Windows System > Control Panel**.
  - Windows 8.1/Windows 8  
Select **Desktop > Settings > Control Panel**.
  - Windows 7/Windows Vista/Windows XP  
Click the start button and select **Control Panel**.
4. Open **Uninstall a program** (or **Add or Remove Programs**):
  - Windows 10/Windows 8.1/Windows 8/Windows 7/Windows Vista  
Select **Uninstall a program** in **Programs**.
  - Windows XP  
Click **Add or Remove Programs**.
5. Select the application you want to uninstall.  
You cannot uninstall the printer driver if there is any print jobs. Delete or wait to be printed the jobs before uninstalling.
6. Uninstall the applications:
  - Windows 10/Windows 8.1/Windows 8/Windows 7/Windows Vista  
Click **Uninstall/Change** or **Uninstall**.



## Network Service and Software Information

- Windows XP



Click **Change/Remove** or **Remove**.

**Note:**

If the **User Account Control** window is displayed, click **Continue**.

7. Follow the on-screen instructions.

## Uninstalling Applications - Mac OS

1. Download the Uninstaller using EPSON Software Updater.  
Once you have downloaded the Uninstaller, you do not need to download it again each time you uninstall the application.
2. Press the  button to turn off the printer.
3. To uninstall the printer driver, select **System Preferences** from the  menu > **Printers & Scanners** (or **Print & Scan, Print & Fax**), and then remove the printer from the enabled printers list.
4. Quit all running applications.
5. Select **Go > Applications > Epson Software > Uninstaller**.
6. Select the application you want to uninstall, and then click **Uninstall**.



**Important:**

The Uninstaller removes all drivers for Epson inkjet printers on the computer. If you use multiple Epson inkjet printers and you only want to delete some drivers, delete all of them first, and then install the necessary printer driver again.

**Note:**

If you cannot find the application you want to uninstall in the application list, you cannot uninstall using the Uninstaller. In this situation, select **Go > Applications > Epson Software**, select the application you want to uninstall, and then drag it to the trash icon.

### Related Information

- ➔ [“Software Update Tools \(EPSON Software Updater\)” on page 198](#)

# Solving Problems

## Checking the Printer Status

### Checking Messages on the LCD Screen

If a message is displayed on the LCD screen, follow the on-screen instructions or the solutions below to solve the problem.

Error Messages	Solutions
<p>Printer Error</p> <p>Turn on the printer again. See your documentation for more details.</p>	<p>Do the following.</p> <ol style="list-style-type: none"> <li>1. Open the scanner unit and remove any paper or protective material inside the printer.</li> <li>2. Close the scanner unit and turn the power off and on again.</li> </ol> <p>If the error message is still displayed after turning the power off and on again, contact Epson support.</p> <p><a href="#">"Contacting Epson Support" on page 249</a></p>
<p>An error occurred while saving. Check and if necessary, change the memory device.</p>	<p>The external storage device, such as a memory card, may be damaged. Check if the device is available.</p>
<p>Ink is low.</p>	<p>You can continue printing until you are prompted to replace the ink cartridges. However, note that the printer cannot print if any of the ink cartridges is expended. Prepare new cartridges as soon as possible.</p>
<p>Ink cartridge(s) are low. Print job may not print completely.</p>	<p>Select <b>Continue printing</b> or <b>Replace before printing</b>.</p> <p>When you select <b>Continue printing</b>, the printer may stop printing indicating it is time to replace the ink cartridge. In this case, printing fails and the paper is ejected. Select <b>No, cancel printing</b>, and then replace the cartridge. If you select <b>Yes, replace now</b>, printing continues after you replace the cartridge and more paper is wasted.</p> <p>When the printer stops during copying indicating it is time to replace the cartridge, the original on the scanner glass may move when you open and close the scanner unit to replace the cartridge. Place the original by aligning it with the corner mark on the scanner glass, and then start copying.</p>
<p>You need to replace the following ink cartridge(s).</p>	<p>To ensure you receive premium print quality and to help protect your print head, a variable ink safety reserve remains in the cartridge when your printer indicates it is time to replace the cartridge. Replace the cartridge when you are prompted to do so.</p>
<p>The printer's borderless printing ink pad is nearing the end of its service life. It is not a user-replaceable part. Please contact Epson support.</p>	<p>Contact Epson or an authorised Epson service provider to replace the borderless printing ink pad*. It is not a user-serviceable part.</p> <p>Select <b>OK</b> to resume printing.</p> <p><a href="#">"Contacting Epson Support" on page 249</a></p>

## Solving Problems

Error Messages	Solutions
<p>The printer's borderless printing ink pad has reached the end of its service life. It is not a user-replaceable part. Please contact Epson support.</p>	<p>Contact Epson or an authorised Epson service provider to replace the borderless printing ink pad*. It is not a user-serviceable part.</p> <p>Borderless printing is not available, but printing with a border is available.</p> <p><a href="#">"Contacting Epson Support" on page 249</a></p>
<p>Paper Configuration is set to Off. Some features such as paper size and type settings may be unavailable. For details, see your documentation.</p>	<p>If <b>Paper Configuration</b> is disabled, you cannot use AirPrint. In addition, messages notifying you that the paper size and type do not match are not displayed. Keep this setting enabled unless you always use the same size and type of paper and do not need to change the paper settings.</p>
<p>Communication error. Check if the computer is connected.</p>	<p>Connect the computer and the printer correctly. If you are connecting over a network, see the page that describes the network connection method from the computer.</p> <p>If the error message is displayed during scanning, make sure that Epson Scan 2 and Epson Event Manager are installed on the computer.</p> <p><a href="#">"Connecting to a Computer" on page 27</a></p>
<p>The combination of the IP address and the subnet mask is invalid. See your documentation for more details.</p>	<p>Enter the correct IP address or default gateway. Contact the person who setup the network for assistance.</p>
<p>To use cloud services, update the root certificate from the Epson Web Config utility.</p>	<p>Run Web Config, and then update the root certificate.</p> <p><a href="#">"Application for Configuring Printer Operations (Web Config)" on page 186</a></p>
<p>Cannot recognize the media. See your documentation for more details about the media</p>	<p>See the link below.</p> <p><a href="#">"External Storage Device Specifications" on page 240</a></p>
<p>Cannot use the inserted Memory Device. See your documentation for details.</p>	<p>See the link below.</p> <p><a href="#">"External Storage Device Specifications" on page 240</a></p>
<p>Print Head Adjustment Canceled. There is a problem with the print head. Contact Epson Support.</p>	<p>If print quality has not improved after repeating nozzle check and head cleaning about three times, wait for at least six hours without printing, and then run the nozzle check again and repeat the head cleaning if necessary. We recommend to turn off the printer. If print quality has still not improved, contact Epson support.</p>
<p>Install the Epson Event Manager software in the computer to use this feature. See your documentation for more details.</p>	<p>See the link below.</p> <p><a href="#">"Installing Applications" on page 198</a></p>
<p>Check the followings when the computer is not found.</p> <ul style="list-style-type: none"> <li>- Connection between the printer and the computer (USB or network)</li> <li>- Installation of necessary software</li> <li>- Computer powered on</li> <li>- Settings for firewall and security software</li> <li>- Search again</li> </ul> <p>See your documentation for more details.</p>	<p>See the link below.</p> <p><a href="#">"Connecting to a Computer" on page 27</a></p> <p><a href="#">"Installing Applications" on page 198</a></p> <p><a href="#">"Application Is Blocked by a Firewall (for Windows Only)" on page 236</a></p>

## Solving Problems

Error Messages	Solutions
Check that the printer driver is installed on the computer and that the port settings for the printer are correct.	Make sure the printer port is selected correctly in <b>Property &gt; Port</b> from the <b>Printer</b> menu as follows.  Select " <b>USBXXX</b> " for a USB connection, or " <b>EpsonNet Print Port</b> " for a network connection.
Check that the printer driver is installed on the computer and that the USB port settings for the printer are correct.	
Access the following or see documentation for details. Select [Dismiss] after confirming it.	See the link below.  <a href="#">"Connecting to a Smart Device" on page 28</a>
Paper settings for XX do not match the Print Settings. Pull out Paper Cassette 1 or Paper Cassette 2 to place the following paper. XX XX	Load paper that matches the print settings in the paper cassette, and then change the paper settings or change the print settings.  If you do not want to display this message from the next time, select <b>Settings &gt; Printer Settings &gt; Paper Source Setting</b> , and then set <b>Paper Configuration</b> to <b>Off</b> .
The paper size and type set in XX does not match specified Print Settings.	Load paper that matches the print settings in the paper cassette, and then change the paper settings or change the print settings.  If you do not want to display this message from the next time, select <b>Settings &gt; Guide Functions</b> , and then set <b>Paper Mismatch</b> to <b>Off</b> .
No paper has been loaded that matches the paper size setting.	Change the print settings according to the paper size loaded in the paper cassette, or load paper in the paper cassette that matches the print settings.  If you do not want to display this message from the next time, select <b>Settings &gt; Guide Functions</b> , and then set <b>Paper Mismatch</b> to <b>Off</b> .
Recovery Mode	The printer has started in recovery mode because the firmware update failed. Follow the steps below to try to update the firmware again.  1. Connect the computer and the printer with a USB cable. (During recovery mode, you cannot update the firmware over a network connection.)  2. Visit your local Epson website for further instructions.

\*In some print cycles a very small amount of surplus ink may be collected in the borderless printing ink pad. To prevent ink leakage from the pad, the product is designed to stop borderless printing when the pad has reached its limit. Whether and how often this is required will vary according to the number of pages you print using the borderless print option. The need for replacement of the pad does not mean that your printer has ceased to operate in accordance with its specifications. The printer will advise you when the pad requires replacing and this can only be performed by an authorised Epson Service provider. The Epson warranty does not cover the cost of this replacement.

## Checking the Printer Status - Windows

1. Access the printer driver window.

## Solving Problems

2. Click **EPSON Status Monitor 3** on the **Maintenance** tab.

**Note:**

- You can also check the printer status by double-clicking the printer icon on the taskbar. If the printer icon is not added to the taskbar, click **Monitoring Preferences** on the **Maintenance** tab, and then select **Register the shortcut icon to the taskbar**.
- If **EPSON Status Monitor 3** is disabled, click **Extended Settings** on the **Maintenance** tab, and then select **Enable EPSON Status Monitor 3**.

### Related Information

- ➔ [“Windows Printer Driver” on page 188](#)

## Checking the Printer Status - Mac OS

1. Select **System Preferences** from the  menu > **Printers & Scanners** (or **Print & Scan**, **Print & Fax**), and then select the printer.
2. Click **Options & Supplies** > **Utility** > **Open Printer Utility**.
3. Click **EPSON Status Monitor**.

You can check the printer status, ink levels, and error status.

---

## Removing Jammed Paper

Check the error displayed on the control panel and follow the instructions to remove the jammed paper including any torn pieces. Next, clear the error.



**Important:**

*Remove the jammed paper carefully. Removing the paper vigorously may cause damage to the printer.*

## Removing Jammed Paper from Inside the Printer



**Caution:**

- Be careful not to trap your hand or fingers when opening or closing the scanner unit. Otherwise you may be injured.
- Never touch the buttons on the control panel while your hand is inside the printer. If the printer starts operating, it could cause an injury. Be careful not to touch the protruding parts to avoid injury.

## Solving Problems

1. Open the scanner unit with the document cover closed.

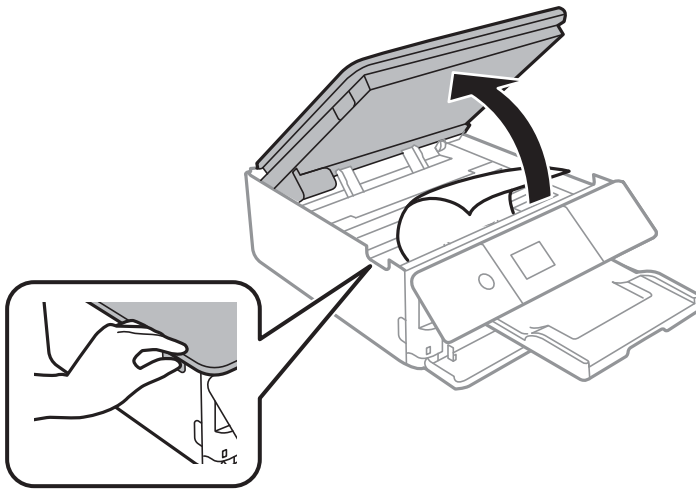

2. Remove the jammed paper.

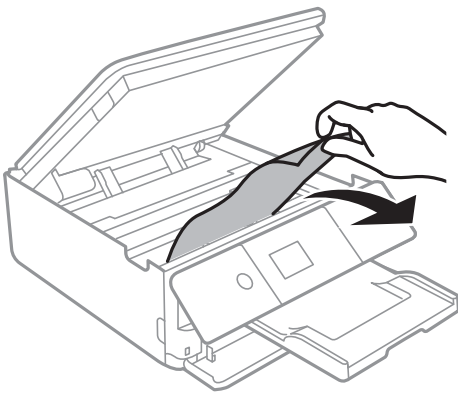

## Solving Problems

**!** *Important:*

*Do not touch the white flat cable or translucent film inside the printer. Doing so may cause a malfunction.*

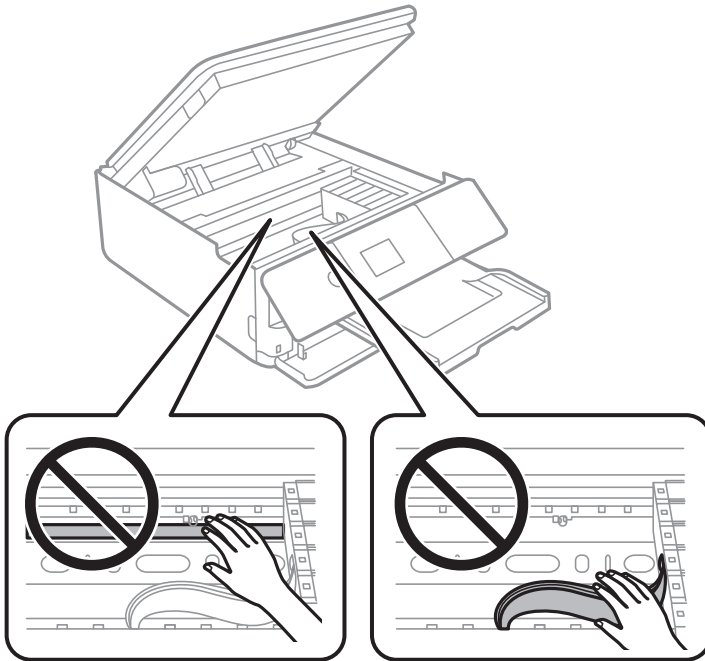

3. Close the scanner unit.

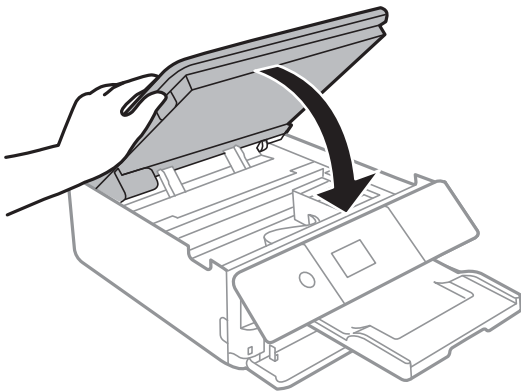

## Removing Jammed Paper from Rear Cover

1. Remove the rear cover.

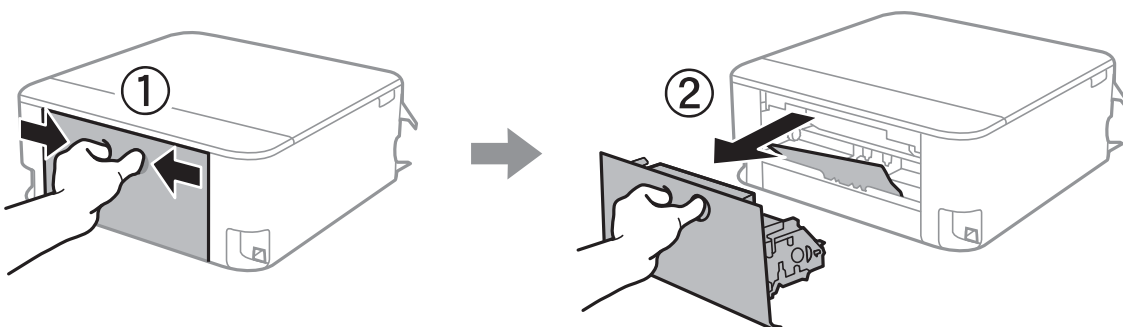

## Solving Problems

2. Remove the jammed paper.

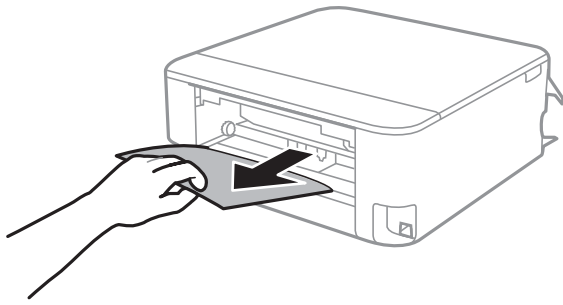

3. Remove jammed paper from the rear cover.

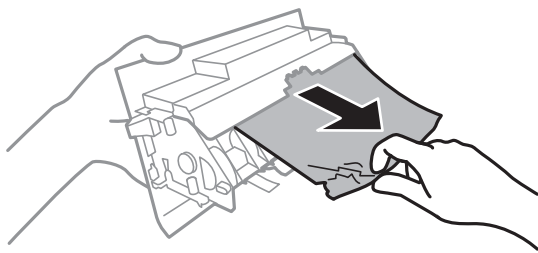

4. Insert the rear cover in the printer.

## Removing Jammed Paper from the Paper Cassette

1. Store the output tray.
2. Pull out the paper cassette.  
For paper cassette 2, lift it up slightly, and then pull it out.

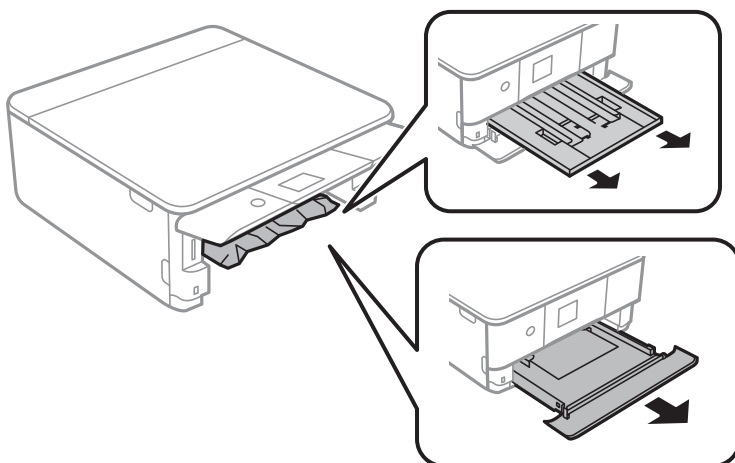



## Solving Problems

3. Remove the jammed paper.

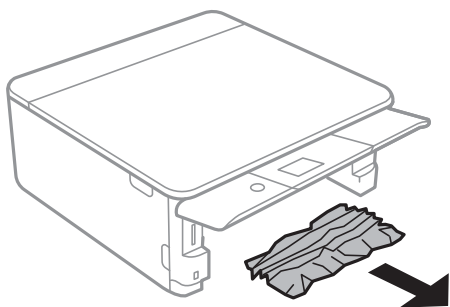

4. Align the edges of the paper and slide the edge guides to the edges of the paper.

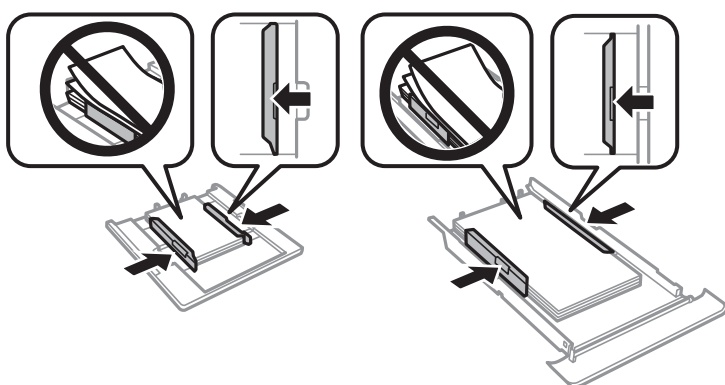

5. Insert the paper cassette in the printer.

---

## Paper Does Not Feed Correctly

Check the following points, and then take the appropriate actions to solve the problem.

- Place the printer on a flat surface and operate in the recommended environmental conditions.
- Use paper supported by this printer.
- Follow the paper handling precautions.
- Do not load more than the maximum number of sheets specified for the paper.
- Make sure the paper size and paper type settings match the actual paper size and paper type loaded in the printer.
- Clean the roller inside the printer.

### Related Information

- ➔ [“Environmental Specifications” on page 243](#)
- ➔ [“Paper Handling Precautions” on page 57](#)
- ➔ [“Available Paper and Capacities” on page 58](#)
- ➔ [“List of Paper Types” on page 60](#)
- ➔ [“Cleaning the Paper Path for Paper Feeding Problems” on page 174](#)

## Solving Problems

### Paper Jams

- Load paper in the correct direction, and slide the edge guides against the edges of the paper.
- Load one sheet of paper at a time if you have loaded several sheets of paper.

#### Related Information

- ➔ [“Removing Jammed Paper” on page 205](#)
- ➔ [“Loading Paper in the Paper Cassette 1” on page 62](#)
- ➔ [“Loading Paper in the Paper Cassette 2” on page 66](#)

### Paper Feeds at a Slant

Load paper in the correct direction, and slide the edge guides against the edges of the paper.

#### Related Information

- ➔ [“Loading Paper in the Paper Cassette 1” on page 62](#)
- ➔ [“Loading Paper in the Paper Cassette 2” on page 66](#)

### Several Sheets of Paper are Fed at a Time

- Load one sheet of paper at a time.
- When several sheets of paper are fed at a time during manual 2-sided printing, remove any paper which is loaded in the printer before you reload the paper.

### CD/DVD Tray is Ejected

- Make sure the disc is properly set on the tray and reinsert the tray correctly.
- Do not insert the CD/DVD tray until you are instructed to do so. Otherwise, an error occurs and the tray is ejected.

#### Related Information

- ➔ [“Printing Photos onto a CD/DVD Label” on page 93](#)
- ➔ [“Copying on a CD/DVD Label” on page 130](#)



---

## Power and Control Panel Problems

### Power Does Not Turn On

- Make sure the power cord is securely plugged in.
- Hold down the  button for a little longer.

## Power Does Not Turn Off

Hold down the  button for a little longer. If you still cannot turn off the printer, unplug the power cord. To prevent the print head from drying out, turn the printer back on and turn it off by pressing the  button.

## Power Turns Off Automatically

- Select **Settings** > **Basic Settings** > **Power Off Settings**, and then disable the **Power Off If Inactive** and **Power Off If Disconnected** settings.
- Select **Settings** > **Basic Settings**, and then disable the **Power Off Timer** Setting.

**Note:**

Your product may have the **Power Off Settings** or **Power Off Timer** feature depending on the location of purchase.

## LCD Screen Gets Dark

The printer is in sleep mode. Press any button on the control panel to return the LCD screen to its former state.

## The Auto Power On Features does not Work

- Make sure that the **Auto Power On** setting in **Basic Settings** has been enabled.
- Make sure that the printer is properly connected with a USB cable or to a network.

**Related Information**

➔ [“Menu Options for Basic Settings” on page 180](#)

---

## Cannot Print from a Computer

### Checking the Connection (USB)

- Connect the USB cable securely to the printer and the computer.
- If you are using a USB hub, try to connect the printer directly to the computer.
- If the USB cable cannot be recognized, change the port, or change the USB cable.

## Solving Problems

- ❑ If the printer cannot print using a USB connection, try the following.

Disconnect the USB cable from the computer. Right-click on the printer icon displayed on the computer, and then select **Remove Device**. Next, connect the USB cable to the computer and try a test print.

Re-set the USB connection by following the steps in this manual for changing the connection method to a computer. See the related information link below for details.

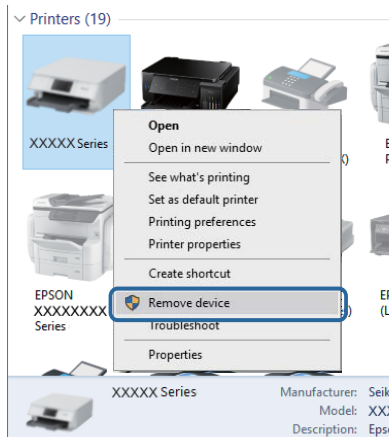

### Related Information

- ➔ [“Changing the Connection Method to a Computer” on page 52](#)

## Checking the Connection (Network)

- ❑ If you cannot print over a network, see the page that describes the network connection method from the computer.
- ❑ If the printing speed is slow or printing pauses, there may be a connection problem with the network devices. Move the printer closer to the access point, and then turn the access point off and then on. If this does not clear the problem, see the documentation provided with your access point.
- ❑ When you have changed your access point or provider, try making network settings for the printer again. Connect the computer or smart device to the same SSID as the printer.
- ❑ Turn off the devices you want to connect to the network. Wait for about 10 seconds, and then turn on the devices in the following order; access point, computer or smart device, and then printer. Move the printer and computer or smart device closer to the access point to help with radio wave communication, and then try to make network settings again.
- ❑ Print the network connection report. See the related information link below for details. If the report shows that the network connection failed, check the network connection report and then follow the printed solutions.
- ❑ If the IP address assigned to the printer is 169.254.XXX.XXX, and the subnet mask is 255.255.0.0, the IP address may not be assigned correctly. Restart the access point or reset the network settings for the printer. If this does not solve the problem, see the documentation for the access point.
- ❑ Try accessing any website from your computer to make sure that your computer's network settings are correct. If you cannot access any website, there is a problem on the computer. Check the network connection of the computer.

### Related Information

- ➔ [“Connecting to a Computer” on page 27](#)
- ➔ [“Printing a Network Connection Report” on page 45](#)

## Checking the Software and Data

- ❑ Make sure that a genuine Epson printer driver is installed. If a genuine Epson printer driver is not installed, the available functions are limited. We recommend using a genuine Epson printer driver. See the related information link below for details.
- ❑ If you are printing a large data size image, the computer may run out of memory. Print the image at a lower resolution or a smaller size.

### Related Information

- ➔ [“Installing Applications” on page 198](#)
- ➔ [“Checking for Genuine Epson Printer Drivers” on page 213](#)

## Checking for Genuine Epson Printer Drivers

You can check if a genuine Epson printer driver is installed on your computer by using one of the following methods.

### Windows

Select **Control Panel > View devices and printers (Printers, Printers and Faxes)**, and then do the following to open the print server properties window.

- ❑ Windows 10/Windows 8.1/Windows 8/Windows 7  
Click the printer icon, and then click **Print server properties** at the top of the window.
- ❑ Windows Vista  
Right-click on the **Printers** folder, and then click **Run as administrator > Server Properties**.
- ❑ Windows XP  
From the **File** menu, select **Server Properties**.

## Solving Problems

Click the **Driver** tab. If your printer name is displayed in the list, a genuine Epson printer driver is installed on your computer.

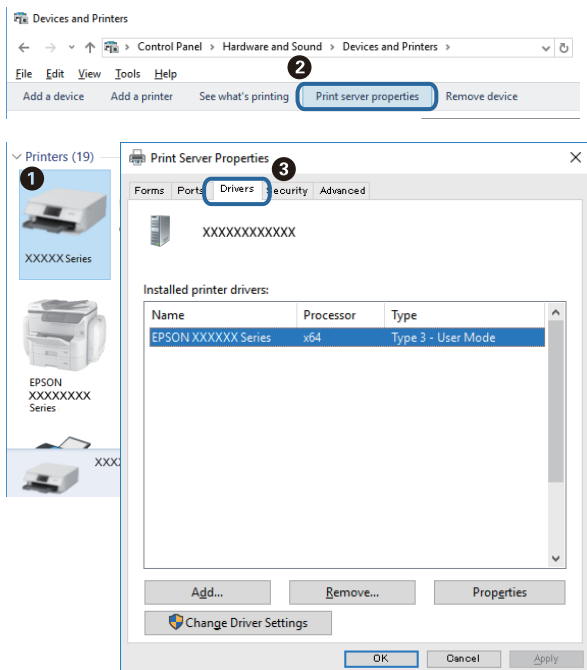

## Mac OS

Select **System Preferences** from the  menu > **Printers & Scanners** (or **Print & Scan, Print & Fax**), and then select the printer. Click **Options & Supplies**, and if the **Options** tab and **Utility** tab are displayed on the window, a genuine Epson printer driver is installed on your computer.



## Related Information

➔ [“Installing Applications” on page 198](#)

## Solving Problems

### Checking the Printer Status from the Computer (Windows)

- ❑ When a message is displayed stating that the connection check tool **EPSON Status Monitor 3** will start, click **OK**. This allows you to automatically clear connection errors or check how to solve problems.
- ❑ Click **EPSON Status Monitor 3** on the printer driver's **Maintenance** tab, and then check the printer status. If **EPSON Status Monitor 3** is disabled, click **Extended Settings** on the **Maintenance** tab, and then select **Enable EPSON Status Monitor 3**.
- ❑ Click **Print Queue** on the printer driver's **Maintenance** tab, and then check the following.

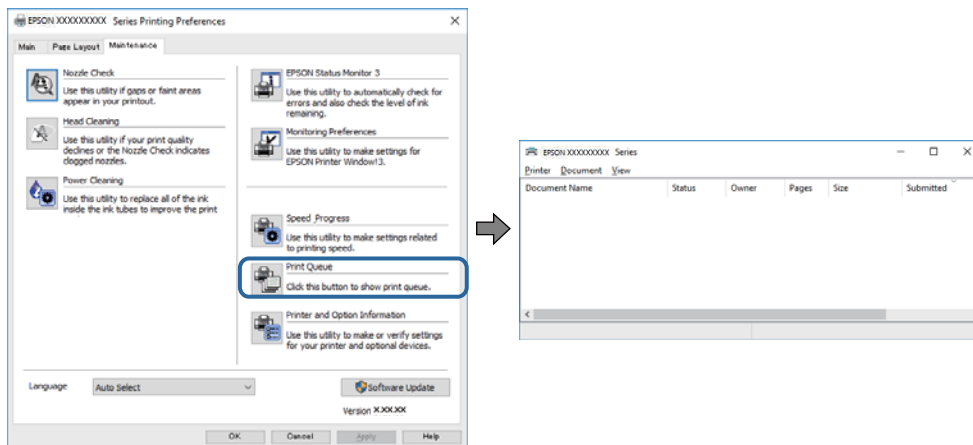

- ❑ Check if there are any paused print jobs.  
If unnecessary data remains, select **Cancel all documents** from the **Printer** menu.
- ❑ Make sure the printer is not offline or pending  
If the printer is offline or pending, clear the offline or pending setting from the **Printer** menu.

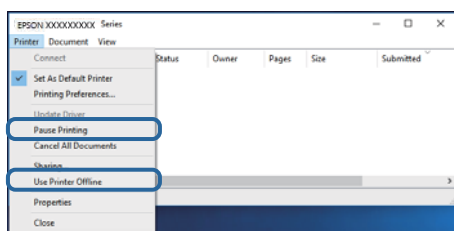

- ❑ Make sure the printer is selected as the default printer from the **Printer** menu (there should be a check mark on the menu item).

If the printer is not selected as the default printer, set it as the default printer. If there are multiple icons in **Control Panel > View devices and printers (Printers, Printers and Faxes)**, see the following to select the icon.

Example)

USB connection: EPSON XXXX Series

Network connection: EPSON XXXX Series (network)

If you install the printer driver multiple times, copies of printer driver may be created. If copies such as "EPSON XXXX Series (copy 1)" are created, right-click the copied driver icon, and then click **Remove Device**.

- ❑ Make sure the printer port is selected correctly in **Property > Port** from the **Printer** menu as follows.  
Select "**USBXXX**" for a USB connection, or "**EpsonNet Print Port**" for a network connection.

**Related Information**

- ➔ [“Canceling Printing” on page 125](#)
- ➔ [“Guide to Windows Printer Driver” on page 189](#)

## Checking the Printer Status from the Computer (Mac OS)

Make sure the printer status is not **Pause**.

Select **System Preferences** from the  menu > **Printers & Scanners** (or **Print & Scan**, **Print & Fax**), and then double-click the printer. If the printer is paused, click **Resume** (or **Resume Printer**).

**Related Information**

- ➔ [“Guide to Mac OS Printer Driver” on page 192](#)

---

## When You Cannot Make Network Settings

- Turn off the devices you want to connect to the network. Wait for about 10 seconds, and then turn on the devices in the following order; wireless router, computer or smart device, and then printer. Move the printer and computer or smart device closer to the wireless router to help with radio wave communication, and then try to make network settings again.
- Select **Settings** > **Network Settings** > **Connection Check**, and then print the network connection report. If an error has occurred, check the network connection report and then follow the printed solutions.

**Related Information**

- ➔ [“Printing a Network Connection Report” on page 45](#)
- ➔ [“Messages and Solutions on the Network Connection Report” on page 46](#)

## Cannot Connect from Devices Even Though Network Settings are No Problems

If you cannot connect from the computer or smart device to the printer even though the network connection report does not show any problems, see the following.



### Solving Problems

- ❑ When you are using multiple wireless routers at the same time, you may not be able to use the printer from the computer or smart device depending on the settings of the wireless routers. Connect the computer or smart device to the same wireless router as the printer.

Disable the tethering function on the smart device if it is enabled.

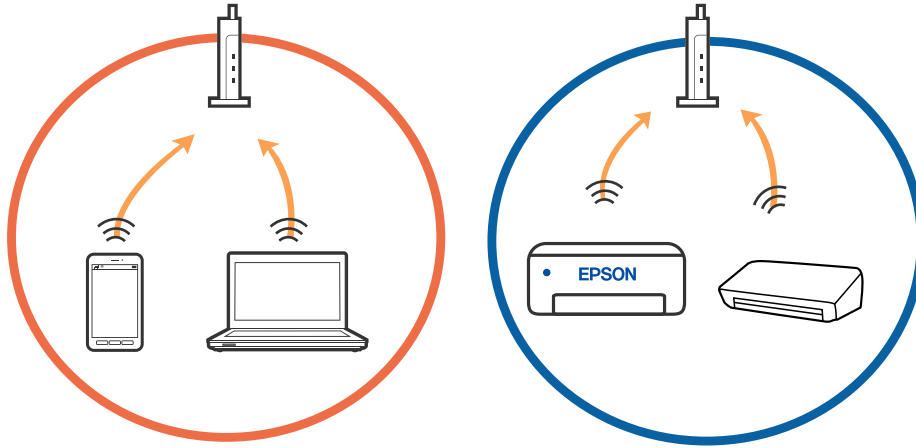

- ❑ You may not be able to connect to the wireless router when the wireless router has multiple SSIDs and devices are connected to different SSIDs on the same wireless router. Connect the computer or smart device to the same SSID as the printer.

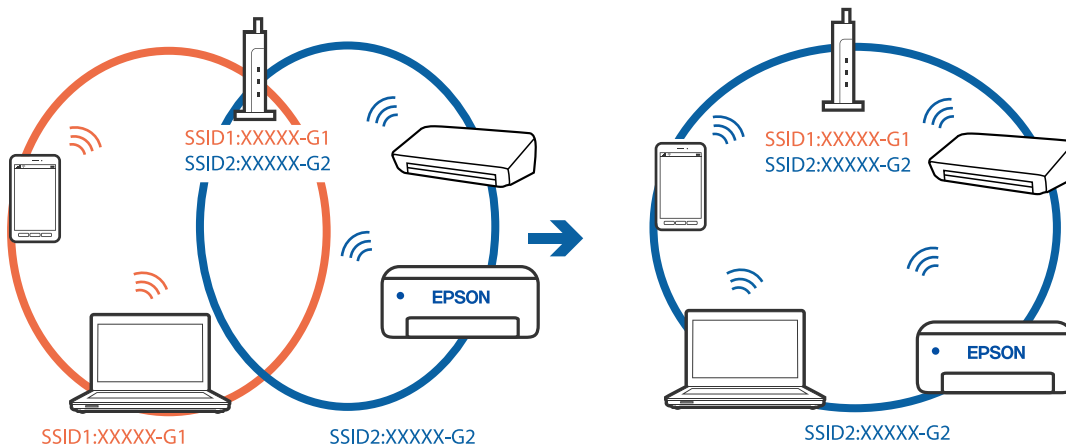

## Solving Problems

- ❑ A wireless router that is compliant with both IEEE802.11a and IEEE802.11g has SSIDs of 2.4 GHz and 5 GHz. If you connect the computer or smart device to a 5 GHz SSID, you cannot connect to the printer because the printer only supports communication over 2.4 GHz. Connect the computer or smart device to the same SSID as the printer.

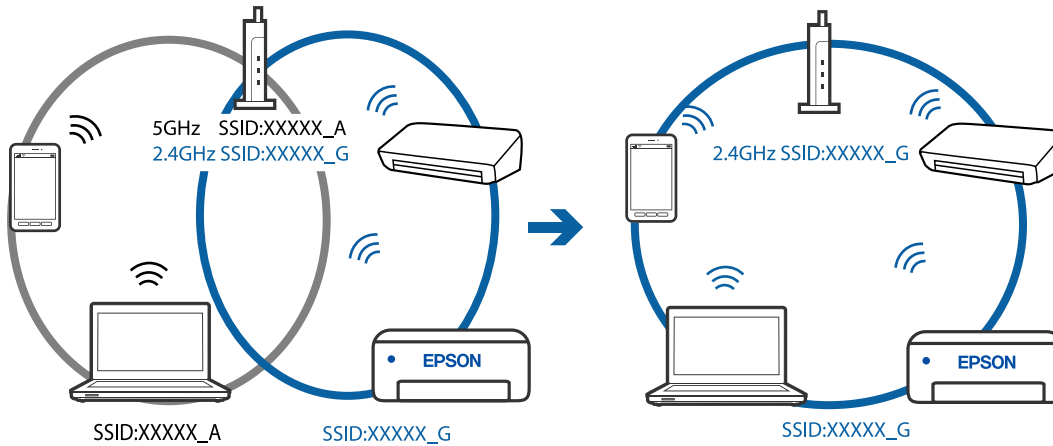

- ❑ Most wireless routers have a privacy separator feature that blocks communication between connected devices. If you cannot communicate between the printer and the computer or smart device even if they are connected to the same network, disable the privacy separator on the wireless router. See the manual provided with the wireless router for details.

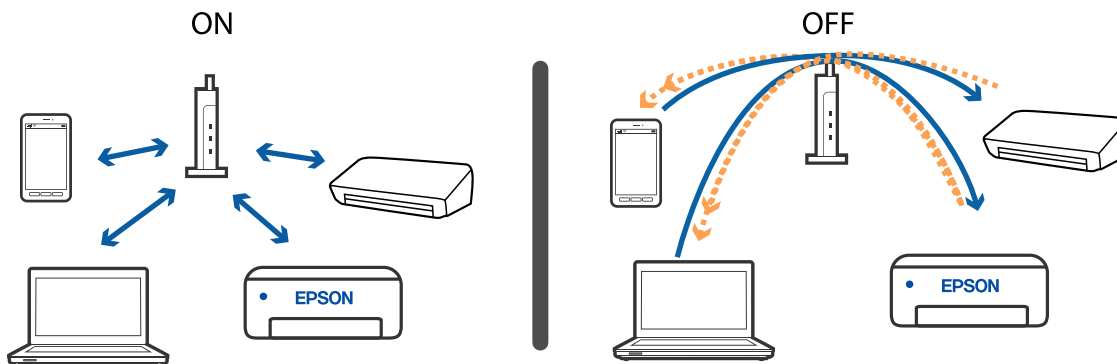

## Related Information

- ➔ [“Checking the SSID Connected to the Printer” on page 218](#)
- ➔ [“Checking the SSID for the Computer” on page 219](#)

## Checking the SSID Connected to the Printer

Select **Settings > Network Settings > Network Status**. You can check the SSID for Wi-Fi and Wi-Fi Direct (Simple AP) from each menu.

## Related Information

- ➔ [“Checking Detailed Network Information from the Control Panel” on page 44](#)

## Checking the SSID for the Computer

### Windows

Click  in the task tray on the desktop. Check the name of the connected SSID from the list displayed.

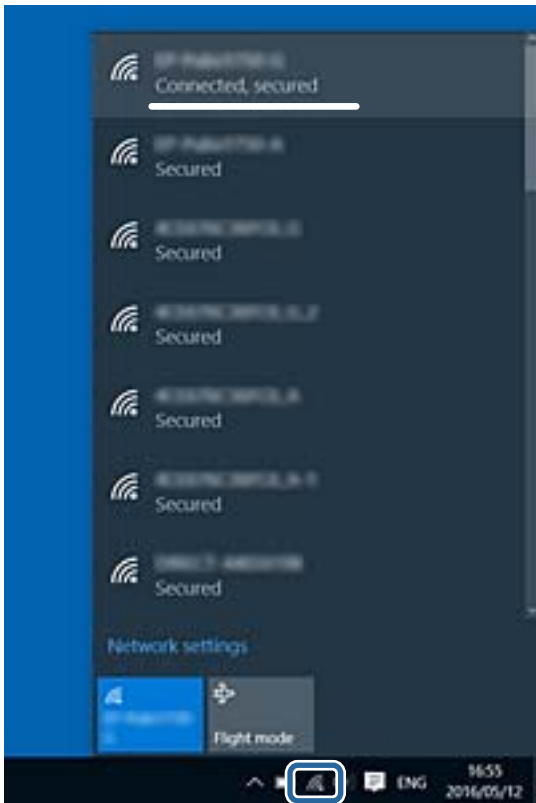

### Mac OS

Click the Wi-Fi icon at the top of the computer screen. A list of SSIDs is displayed and the connected SSID is indicated with a check mark.



---

## Cannot Print from an iPhone or iPad

- Connect the iPhone or iPad to the same network (SSID) as the printer.
- Enable **Paper Configuration** in the following menus.
  - Settings > Printer Settings > Paper Source Setting > Paper Configuration**
- Enable the AirPrint setting on Web Config.

### Related Information

- ➔ [“Connecting to a Smart Device” on page 28](#)
- ➔ [“Application for Configuring Printer Operations \(Web Config\)” on page 186](#)

---

## Printout Problems

### Printout is Scuffed or Color is Missing

If you have not used the printer for a long time, the print head nozzles may be clogged and ink drops may not be discharged. Perform a nozzle check, and then clean the print head if any of the print head nozzles are clogged.

### Related Information

- ➔ [“Checking and Cleaning the Print Head” on page 170](#)

### Banding or Unexpected Colors Appear

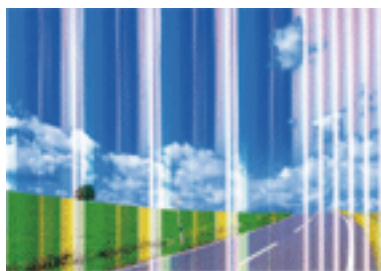

The print head nozzles may be clogged. Perform a nozzle check to check if the print head nozzles are clogged. Clean the print head if any of the print head nozzles are clogged.

### Related Information

- ➔ [“Checking and Cleaning the Print Head” on page 170](#)

## Colored Banding Appears at Intervals of Approximately 2.5 cm

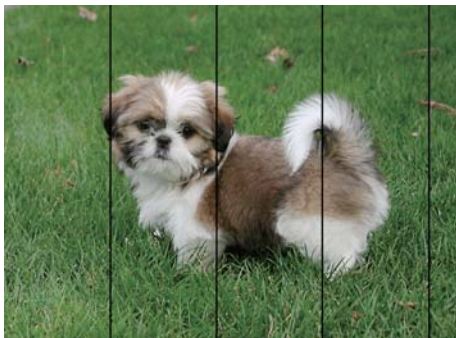

- Select the appropriate paper type setting for the type of paper loaded in the printer.
- Align the print head using the **Horizontal Alignment** feature.
- When printing on plain paper, print using a higher quality setting.

### Related Information

- ➔ [“List of Paper Types” on page 60](#)
- ➔ [“Aligning the Print Head - Control Panel” on page 172](#)

## Blurry Prints, Vertical Banding, or Misalignment



enthalten alle  
 Aufdruck. W  
 ↓ 5008 "Regel

Align the print head using the **Vertical Alignment** feature.

### Related Information

- ➔ [“Aligning the Print Head - Control Panel” on page 172](#)

## Print Quality Does Not Improve Even After Aligning the Print Head

During bidirectional (or high speed) printing, the print head prints while moving in both directions, and vertical lines may be misaligned. If print quality does not improve, disable the bidirectional (or high speed) setting. Disabling this setting may slow down printing speed.

- Control panel
  - Disable **Bidirectional** in **Settings > Printer Settings**.
- Windows
  - Clear **High Speed** on the printer driver's **More Options** tab.

## Solving Problems

### Mac OS

Select **System Preferences** from the  menu > **Printers & Scanners** (or **Print & Scan, Print & Fax**), and then select the printer. Click **Options & Supplies** > **Options** (or **Driver**). Select **Off** as the **High Speed Printing** setting.

### Related Information

- ➔ [“Menu Options for Printer Settings” on page 181](#)
- ➔ [“Guide to Windows Printer Driver” on page 189](#)
- ➔ [“Guide to Mac OS Printer Driver” on page 192](#)

## Print Quality is Poor

Check the following if the print quality is poor due to blurry prints, banding, missing colors, faded colors, and misalignment in the prints.

### Checking the printer

- Perform a nozzle check, and then clean the print head if any of the print head nozzles are clogged.
- Align the print head.

### Checking the paper

- Use paper supported by this printer.
- Do not print on paper that is damp, damaged, or too old.
- If the paper is curled or the envelope is puffed up, flatten it.
- Do not stack the paper immediately after printing.
- Dry the printouts completely before filing or displaying them. When drying the printouts, avoid direct sun light, do not use a dryer, and do not touch the printed side of paper.
- When printing images or photos, Epson recommends using genuine Epson paper rather than plain paper. Print on the printable side of the genuine Epson paper.

### Checking the print settings

- Select the appropriate paper type setting for the type of paper loaded in the printer.
- Select **Best** as the print quality setting on the control panel or the printer driver.

### Checking the ink cartridge

- Epson recommends using the ink cartridge before the date printed on the package.
- For best results, use up ink cartridge within six months of opening the package.
- Try to use genuine Epson ink cartridges. This product is designed to adjust colors based on the use of genuine Epson ink cartridges. The use of non-genuine ink cartridges may cause print quality to decline.

### Related Information

- ➔ [“Checking and Cleaning the Print Head” on page 170](#)
- ➔ [“Aligning the Print Head” on page 171](#)

## Solving Problems

- ➔ “Available Paper and Capacities” on page 58
- ➔ “Paper Handling Precautions” on page 57
- ➔ “List of Paper Types” on page 60

### Paper Is Smearred or Scuffed

- When horizontal banding appears or the top or bottom of the paper is smearred, load paper in the correct direction and slide the edge guides to the edges of the paper.

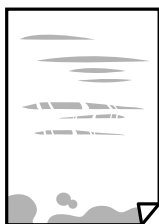

- When vertical banding appears or the paper is smearred, clean the paper path.



- Place the paper on a flat surface to check if it is curled. If it is, flatten it.
- If thick paper is scuffed, enable the reduce scuffing setting. If you enable this setting, print quality may decline or printing may slow down.
  - Control panel
    - Select **Settings** > **Printer Settings** from the home screen, and then enable **Thick Paper**.
  - Windows
    - Click **Extended Settings** on the printer driver's **Maintenance** tab, and then select **Thick Paper and Envelopes**.
  - Mac OS
    - Select **System Preferences** from the  menu > **Printers & Scanners** (or **Print & Scan, Print & Fax**), and then select the printer. Click **Options & Supplies** > **Options** (or **Driver**). Select **On** as the **Thick paper and envelopes** setting.
- When performing manual 2-sided printing, make sure that the ink is completely dry before reloading the paper.

#### Related Information

- ➔ “Loading Paper in the Paper Cassette 1” on page 62
- ➔ “Loading Paper in the Paper Cassette 2” on page 66
- ➔ “Cleaning the Paper Path for Ink Smears” on page 173
- ➔ “Guide to Windows Printer Driver” on page 189

## Solving Problems

➔ [“Guide to Mac OS Printer Driver” on page 192](#)

### Paper is Smearred During Automatic 2-Sided Printing

When using the automatic 2-sided printing feature and printing high density data such as images and graphs, set the print density to lower and the drying time to longer.

#### Related Information

- ➔ [“Printing on 2-Sides” on page 105](#)
- ➔ [“Menu Options for Copying” on page 133](#)

### Printed Photos are Sticky

You may be printing on the wrong side of the photo paper. Make sure you are printing on the printable side. When printing on the wrong side of the photo paper, you need to clean the paper path.

#### Related Information

- ➔ [“Cleaning the Paper Path for Ink Smears” on page 173](#)

### Images or Photos are Printed in Unexpected Colors

When printing from the control panel or from the Windows printer driver, the Epson auto photo adjustment setting (PhotoEnhance) is applied by default depending on the paper type. Try change the setting.

#### Control panel

Change the **Enhance** setting from **Auto** to **People**, **Night Scene**, or **Landscape**. If changing the setting does not work, turn off PhotoEnhance by selecting **Enhance Off**.

#### Windows printer driver

On the **More Options** tab, select **Custom** in **Color Correction**, and then click **Advanced**. Change the **Scene Correction** setting from **Auto Correct** to any other option. If changing the setting does not work, use any color correction method other than **PhotoEnhance** in **Color Management**.

#### Related Information

- ➔ [“Menu Options for Editing Photos” on page 89](#)
- ➔ [“Adjusting the Print Color” on page 118](#)
- ➔ [“Guide to Windows Printer Driver” on page 189](#)



## Colors Differ from What You See on the Display

- ❑ Display devices such as computer screens have their own display properties. If the display is unbalanced, the image are not displayed with proper brightness and colors. Adjust the properties of the device. Next, perform the following.
  - ❑ Windows

Access the printer driver window, select **Custom** as the **Color Correction** setting on the **More Options** tab, and then click **Advanced**. Select **EPSON Standard** as the **Color Mode** setting.
  - ❑ Mac OS

Access the print dialog. Select **Color Options** from the pop-up menu, and then click the arrow next to **Advanced Settings**. Select **EPSON Standard** as the **Mode** setting.
- ❑ Light shining into the display has an effect on how the image is seen on the display. Avoid direct sunlight and confirm the image where an appropriate illuminance is assured.
- ❑ Colors may differ from what you see on smart devices such as smart phones or tablets with high-resolution displays.
- ❑ Colors on a display are not quite identical to those on paper because the display device and the printer have a different process of producing colors.

### Related Information

- ➔ [“Guide to Windows Printer Driver” on page 189](#)
- ➔ [“Guide to Mac OS Printer Driver” on page 192](#)

## Cannot Print Without Margins

Make borderless setting in the print settings. If you select a paper type that does not support borderless printing, you cannot select **Borderless**. Select a paper type that supports borderless printing.

### Related Information

- ➔ [“Menu Options for Paper and Print Settings” on page 88](#)
- ➔ [“Menu Options for Copying” on page 133](#)
- ➔ [“Printing Basics - Windows” on page 101](#)
- ➔ [“Printing Basics - Mac OS” on page 103](#)

## Edges of the Image are Cropped During Borderless Printing

During borderless printing, the image is slightly enlarged and the protruding area is cropped. Select a smaller enlargement setting.

- ❑ Control panel

Change the **Expansion** setting.
- ❑ Windows

Click **Settings** next to the **Borderless** checkbox on the printer driver's **Main** tab, and then change the settings.
- ❑ Mac OS

Change the **Expansion** setting from the print dialog's **Print Settings** menu.

## Solving Problems

### Related Information

- ➔ [“Menu Options for Paper and Print Settings” on page 88](#)
- ➔ [“Menu Options for Copying” on page 133](#)
- ➔ [“Guide to Windows Printer Driver” on page 189](#)
- ➔ [“Guide to Mac OS Printer Driver” on page 192](#)

## The Position, Size, or Margins of the Printout Are Incorrect

- Load paper in the correct direction, and slide the edge guides against the edges of the paper.
- When placing the originals on the scanner glass, align the corner of the original with the corner indicated by a symbol on the frame of the scanner glass. If the edges of the copy are cropped off, move the original slightly away from the corner.
- When placing the originals on the scanner glass, clean the scanner glass and the document cover using a dry, soft, clean cloth. If there is dust or stains on the glass, the copy area may extend to include the dust or stains, resulting in the wrong copying position or small images.

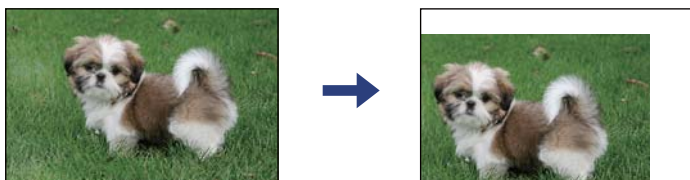

- Select the appropriate paper size setting.
- Adjust the margin setting in the application so that it falls within the printable area.

### Related Information

- ➔ [“Loading Paper in the Paper Cassette 1” on page 62](#)
- ➔ [“Loading Paper in the Paper Cassette 2” on page 66](#)
- ➔ [“Cleaning the Scanner Glass” on page 176](#)
- ➔ [“Printable Area” on page 237](#)

## Multiple Originals are Copied onto a Single Sheet

When you place multiple originals on the scanner glass to copy them separately, but they are copied onto a single sheet, place the originals at least 5 mm apart. If the problem continues, place one original at a time.

### Related Information

- ➔ [“Placing Photos for Copying” on page 73](#)

## Printing Position of Photo Stickers is Incorrect

Adjust the printing position in the **Printer Settings** > **Stickers** menu on the control panel.

**Related Information**

➔ [“Menu Options for Printer Settings” on page 181](#)

## The Printing or Copying Position on a CD/DVD is Incorrect

- Adjust the printing position in the **Printer Settings > CD/DVD** menu on the control panel.
- Clean the scanner glass and the document cover using a dry, soft, clean cloth. If there is dust or stains on the glass, the copy area may extend to include the dust or stains, resulting in the wrong copying position or small images.

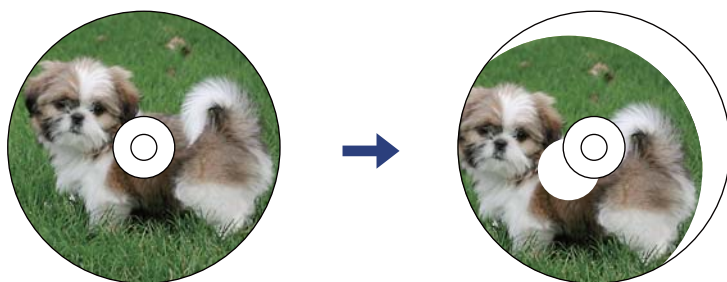
**Related Information**

➔ [“Menu Options for Printer Settings” on page 181](#)

## Printed Characters Are Incorrect or Garbled

- Connect the USB cable securely to the printer and the computer.
- Cancel any paused print jobs.
- Do not put the computer manually into the **Hibernate** mode or the **Sleep** mode while printing. Pages of garbled text may be printed next time you start the computer.

**Related Information**

➔ [“Canceling Printing” on page 125](#)

## The Printed Image Is Inverted

Clear any mirror image settings in the printer driver or the application.

- Windows  
Clear **Mirror Image** on the printer driver's **More Options** tab.
- Mac OS  
Clear **Mirror Image** from the print dialog's **Print Settings** menu.

**Related Information**

- ➔ [“Guide to Windows Printer Driver” on page 189](#)
- ➔ [“Guide to Mac OS Printer Driver” on page 192](#)

## Mosaic-Like Patterns in the Prints

When printing images or photos, print using high-resolution data. Images on websites are often low resolution although they look good enough on the display, and so print quality may decline.

## Uneven Colors, Smears, Dots, or Straight Lines Appear in the Copied Image

- Clean the paper path.
- Clean the scanner glass.
- Do not press too hard on the original or the document cover when you are placing the originals on the scanner glass.
- When the paper is smeared, lower the copy density setting.

### Related Information

- ➔ [“Cleaning the Paper Path for Ink Smears” on page 173](#)
- ➔ [“Cleaning the Scanner Glass” on page 176](#)
- ➔ [“Menu Options for Copying” on page 133](#)

## Moiré (Cross-Hatch) Patterns Appear in the Copied Image

Change the reduce and enlarge setting or place the original at a slightly different angle.

### Related Information

- ➔ [“Menu Options for Copying” on page 133](#)

## An Image of the Reverse Side of the Original Appears in the Copied Image

- For a thin original, place the original on the scanner glass and then place a piece of black paper over it.
- Lower the copy density setting on the control panel.

### Related Information

- ➔ [“Menu Options for Copying” on page 133](#)

## The Printout Problem Could Not be Cleared

If you have tried all of the solutions and have not solved the problem, try uninstalling and then reinstalling the printer driver.



**Related Information**

- ➔ [“Uninstalling Applications” on page 200](#)
- ➔ [“Installing Applications” on page 198](#)

---

## Other Printing Problems

### Printing Is Too Slow

- Close any unnecessary applications.
- Lower the quality setting. High quality printing slows down the printing speed.
- Enable the bidirectional (or high speed) setting. When this setting is enabled, the print head prints while moving in both directions, and the printing speed increases.
  - Control panel  
Enable **Bidirectional** in **Settings > Printer Settings**.
  - Windows  
Select **High Speed** on the printer driver's **More Options** tab.
  - Mac OS  
Select **System Preferences** from the  menu > **Printers & Scanners** (or **Print & Scan, Print & Fax**), and then select the printer. Click **Options & Supplies > Options** (or **Driver**). Select **On** as the **High Speed Printing** setting.
- Disable the **Quiet Mode**.
  - Control panel  
Select  on the home screen, and then disable it.
  - Windows  
Disable **Quiet Mode** on the printer driver's **Main** tab.
  - Mac OS  
Select **System Preferences** from the  menu > **Printers & Scanners** (or **Print & Scan, Print & Fax**), and then select the printer. Click **Options & Supplies > Options** (or **Driver**). Select **Off** as the **Quiet Mode** setting.
- If you are printing over a network, the network device may have a connection problem. Move the printer closer to the device, and then turn the access point off and on again. If the problem cannot be cleared, see the documentation provided with the access point.
- If you are printing high-density data such as photos on plain paper, printing may take some time to maintain print quality. This is not a malfunction.

**Related Information**

- ➔ [“Menu Options for Printer Settings” on page 181](#)
- ➔ [“Guide to Windows Printer Driver” on page 189](#)
- ➔ [“Guide to Mac OS Printer Driver” on page 192](#)

## Printing Slows Down Dramatically During Continuous Printing

Printing slows down to prevent the printer mechanism from overheating and being damaged. However, you can continue printing. To return to normal printing speed, leave the printer idle for at least 30 minutes. Printing speed does not return to normal if the power is off.

## Cannot Cancel Printing from a Computer Running Mac OS X v10.6.8

If you want to stop printing from your computer, make the following settings.

Run Web Config, and then select **Port9100** as the **Top Priority Protocol** setting in **AirPrint Setup**. Select **System Preferences** from the  menu > **Printers & Scanners** (or **Print & Scan**, **Print & Fax**), remove the printer, and then add the printer again.

### Related Information

➔ [“Application for Configuring Printer Operations \(Web Config\)” on page 186](#)

---

## Cannot Start Scanning

- Connect the USB cable securely to the printer and the computer. If you are using a USB hub, try to connect the printer directly to the computer.
- If you scan at a high resolution over a network, a communication error may occur. Lower the resolution.
- Make sure that the correct printer (scanner) is selected on Epson Scan 2.

### Check whether or not the printer is recognized when using Windows

In Windows, make sure the printer (scanner) is displayed in **Scanner and Camera**. The printer (scanner) should be displayed as "EPSON XXXXX (printer name)". If the printer (scanner) is not displayed, uninstall and then re-install Epson Scan 2. See the following to access **Scanner and Camera**.

#### Windows 10

Click on the start button, and then select **Windows System** > **Control Panel**, enter "Scanner and Camera" in the search charm, click **View scanners and cameras**, and then check if the printer is displayed.

#### Windows 8.1/Windows 8

Select **Desktop** > **Settings** > **Control Panel**, enter "Scanner and Camera" in the search charm, click **Show Scanner and Camera**, and then check if the printer is displayed.

#### Windows 7

Click the start button and select **Control Panel**, enter "Scanner and Camera" in the search charm, click **View scanners and cameras**, and then check if the printer is displayed.

#### Windows Vista

Click the start button, select **Control Panel** > **Hardware and Sound** > **Scanners and Cameras**, and then check if the printer is displayed.

#### Windows XP

Click the start button, select **Control Panel** > **Printers and Other Hardware** > **Scanner and Cameras**, and then check if the printer is displayed.

**Related Information**

- ➔ [“Uninstalling Applications” on page 200](#)
- ➔ [“Installing Applications” on page 198](#)

## Cannot Start Scanning when Using the Control Panel

- Make sure Epson Scan 2 and Epson Event Manager are installed correctly.
- Check the scanning setting assigned in Epson Event Manager.

**Related Information**

- ➔ [“Application for Scanning Documents and Images \(Epson Scan 2\)” on page 194](#)
- ➔ [“Application for Configuring Scanning Operations from the Control Panel \(Epson Event Manager\)” on page 195](#)

---

## Scanned Image Problems

### Uneven Colors, Dirt, Spots, and so on Appear when Scanning from the Scanner Glass

- Clean the scanner glass.
- Remove any trash or dirt that adheres to the original.
- Do not press with too much force on the original or the document cover. If you press with too much force, blurring, smudges, and spots may occur.

**Related Information**

- ➔ [“Cleaning the Scanner Glass” on page 176](#)

### The Image Quality Is Rough

- Set the **Mode** in Epson Scan 2 according to the original you want to scan. Scan using the settings for documents in **Document Mode**, and the settings for photos in **Photo Mode**.
- In Epson Scan 2, adjust the image using items on the **Advanced Settings** tab, and then scan.
- If the resolution is low, try increasing the resolution and then scanning.

**Related Information**

- ➔ [“Scanning Using Epson Scan 2” on page 145](#)

### Offset Appears in the Background of Images

Images on the back of the original may appear in the scanned image.

## Solving Problems

- ❑ In Epson Scan 2, select the **Advanced Settings** tab, and then adjust the **Brightness**.  
This feature may not be available depending on the settings on the **Main Settings** tab > **Image Type** or other settings on the **Advanced Settings** tab.
- ❑ In **Document Mode** in Epson Scan 2, select the **Advanced Settings** tab, and then **Image Option** > **Text Enhancement**.
- ❑ When scanning from the scanner glass, place black paper or a desk pad over the original.

### Related Information

- ➔ [“Placing Originals on the Scanner Glass” on page 72](#)
- ➔ [“Scanning Using Epson Scan 2” on page 145](#)

## Text is Blurred

- ❑ In **Document Mode** in Epson Scan 2, select the **Advanced Settings** tab, and then **Image Option** > **Text Enhancement**.
- ❑ Select **Document Mode** as the **Mode** in Epson Scan 2. Scan using the settings for documents in **Document Mode**.
- ❑ In **Document Mode** in Epson Scan 2, when **Image Type** on the **Main Settings** tab is set to **Black & White**, adjust **Threshold** on the **Advanced Settings** tab. When you increase the **Threshold**, the black color area becomes larger.
- ❑ If the resolution is low, try increasing the resolution and then scanning.

### Related Information

- ➔ [“Scanning Documents \(Document Mode\)” on page 145](#)

## Moiré Patterns (Web-Like Shadows) Appear

If the original is a printed document, moiré patterns (web-like shadows) may appear in the scanned image.

- ❑ On the **Advanced Settings** tab in Epson Scan 2, set **Descreening**.

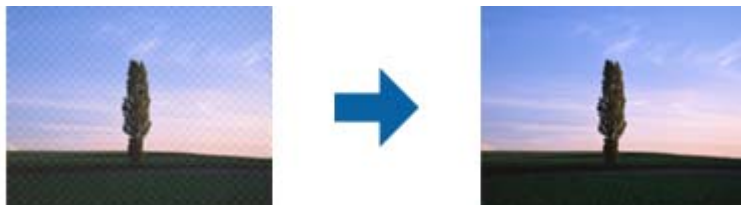

- ❑ Change the resolution, and then scan again.

### Related Information

- ➔ [“Scanning Using Epson Scan 2” on page 145](#)



## Solving Problems

### Cannot Scan the Correct Area on the Scanner Glass

- Make sure the original is placed correctly against the alignment marks.
- If the edge of the scanned image is missing, move the original slightly away from the edge of the scanner glass.
- When placing multiple originals on the scanner glass, make sure there is a gap of at least 20 mm (0.79 in.) between the originals.
- When scanning from the control panel and selecting the auto scan area cropping function, remove any trash or dirt from the scanner glass and document cover. If there is any trash or dirt around the original, the scanning range expands to include it.

#### Related Information

- ➔ [“Placing Originals on the Scanner Glass” on page 72](#)

### Cannot Preview in Thumbnail

- When placing multiple originals on the scanner glass, make sure there is a gap of at least 20 mm (0.79 in.) between the originals.
- Check that the original is placed straight.
- Depending on the original, previewing may not be performed in **Thumbnail**. In this situation, clear the **Thumbnail** check box at the top of the preview widow to preview the entire scanned area, and then create marquees manually.

#### Related Information

- ➔ [“Scanning Photos or Pictures \(Photo Mode\)” on page 148](#)

### Text is Not Recognized Correctly when Saving as a Searchable PDF

- On the **Image Format Options** window in Epson Scan 2, check that **Text Language** is set correctly on the **Text** tab.
- Check that the original is placed straight.
- Use an original with clear text. Text recognition may decline for the following types of originals.
  - Originals that have been copied a number of times
  - Originals received by fax (at low resolutions)
  - Originals on which the letter spacing or line spacing is too small
  - Originals with ruled lines or underlining over the text
  - Originals with hand-written text
  - Originals with creases or wrinkles
- In **Document Mode** in Epson Scan 2, when **Image Type** on the **Main Settings** tab is set to **Black & White**, adjust **Threshold** on the **Advanced Settings** tab. When you increase the **Threshold**, black becomes stronger.
- In **Document Mode** in Epson Scan 2, select the **Advanced Settings** tab, and then **Image Option** > **Text Enhancement**.

**Related Information**

➔ [“Scanning Documents \(Document Mode\)” on page 145](#)

## Cannot Solve Problems in the Scanned Image

If you have tried all of the solutions and have not solved the problem, initialize the Epson Scan 2 settings using Epson Scan 2 Utility.

**Note:**

*Epson Scan 2 Utility is an application that comes with Epson Scan 2.*

1. Start Epson Scan 2 Utility.

Windows 10

Click the start button, and then select **EPSON > Epson Scan 2 Utility**.

Windows 8.1/Windows 8

Enter the application name in the search charm, and then select the displayed icon.

Windows 7/Windows Vista/Windows XP

Click the start button, and then select **All Programs** or **Programs > EPSON > Epson Scan 2 > Epson Scan 2 Utility**.

Mac OS

Select **Go > Applications > Epson Software > Epson Scan 2 Utility**.

2. Select the **Other** tab.

3. Click **Reset**.

**Note:**

*If initialization does not solve the problem, uninstall and re-install Epson Scan 2.*

**Related Information**

➔ [“Uninstalling Applications” on page 200](#)

➔ [“Installing Applications” on page 198](#)

---

## Other Scanning Problems

### Scanning Speed Is Slow

Lower the resolution, and then scan again. When the resolution is high, scanning may take some time.

The scanning speed may be reduced depending on the image adjustment features in Epson Scan 2.

On the **Configuration** screen which is displayed by clicking the  button in Epson Scan 2, if you set **Quiet Mode** on the **Scan** tab, the scanning speed may be reduced.

**Related Information**

➔ [“Scanning Using Epson Scan 2” on page 145](#)

## Scanning Stops when Scanning to PDF/Multi-TIFF

- When scanning using Epson Scan 2, you can continuously scan up to 999 pages in PDF format and up to 200 pages in Multi-TIFF format.
- When scanning large volumes, we recommend scanning in grayscale.
- Increase the free space on the computer's hard disk. Scanning may stop if there is not enough free space.
- Try scanning at a lower resolution. Scanning stops if the total data size reaches the limit.

### Related Information

- ➔ [“Scanning Using Epson Scan 2” on page 145](#)

---

## Other Problems

### Slight Electric Shock when Touching the Printer

If many peripherals are connected to the computer, you may feel a slight electric shock when touching the printer. Install a ground wire to the computer that is connected to the printer.

### Operation Sounds Are Loud

If operations sounds are too loud, enable **Quiet Mode**. Enabling this feature may reduce printing speed.

- Control panel

Select  on the home screen, and then enable **Quiet Mode**.

- Windows printer driver

Enable **Quiet Mode** on the **Main** tab.

- Mac OS printer driver

Select **System Preferences** from the  menu > **Printers & Scanners** (or **Print & Scan, Print & Fax**), and then select the printer. Click **Options & Supplies** > **Options** (or **Driver**). Select **On** as the **Quiet Mode** setting.

- Epson Scan 2

Click the  button to open the **Configuration** window. Next, set the **Quiet Mode** on the **Scan** tab.

### Related Information

- ➔ [“Guide to Windows Printer Driver” on page 189](#)
- ➔ [“Guide to Mac OS Printer Driver” on page 192](#)

### Cannot Save Data to a Memory Device

- Use a memory device that is supported by the printer.
- Check that the memory device is not write protected.

## Solving Problems

- ❑ Check that the memory device has enough available memory. If the available memory is low, data cannot be saved.

### Related Information

- ➔ [“Supported External Storage Device Specifications” on page 241](#)

## Application Is Blocked by a Firewall (for Windows Only)

Add the application to the Windows Firewall allowed program in security settings on the **Control Panel**.

## "!" Is Displayed on the Photo Selection Screen

"!" is displayed on the LCD screen when the image file is not supported by the product.

### Related Information

- ➔ [“Supported Data Specifications” on page 241](#)

# Appendix

## Technical Specifications

### Printer Specifications

Print Head Nozzle Placement		Black ink nozzles: 360 Photo black ink nozzles: 180 Color ink nozzles: 180 for each color
Weight of Paper*	Plain Paper	64 to 90 g/m <sup>2</sup> (17 to 24lb)
	Envelopes	Envelope #10, DL, C6: 75 to 90 g/m <sup>2</sup> (20 to 24 lb)

\* Even when the paper thickness is within this range, the paper may not feed in the printer or the print quality may decline depending on the paper properties or quality.

### Printable Area

#### Printable Area for Single Sheets

Print quality may decline in the shaded areas due to the printer's mechanism.

#### Printing with borders

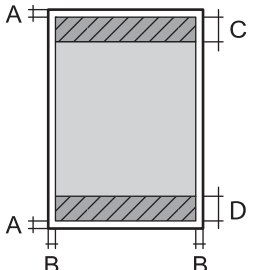
	A	3.0 mm (0.12 in.)
	B	3.0 mm (0.12 in.)
	C	41.0 mm (1.61 in.)
	D	37.0 mm (1.46 in.)

#### Borderless printing

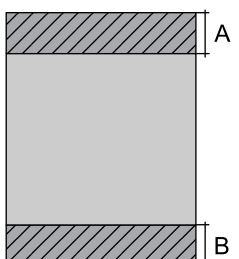
	A	44.0 mm (1.73 in.)
	B	40.0 mm (1.57 in.)

**Appendix**

**Printable Area for Envelopes**

Print quality may decline in the shaded areas due to the printer's mechanism.

	A	3.0 mm (0.12 in.)
	B	5.0 mm (0.20 in.)
	C	18.0 mm (0.71 in.)
	D	41.0 mm (1.61 in.)

**Printable Area for CD/DVD**

Print quality may decline in the shaded areas due to the printer's mechanism.

	A	18 mm (0.71 in.)
	B	43 mm (1.69 in.)
	C	116 mm (4.57 in.)
	D	120 mm (4.72 in.)

**Scanner Specifications**

Scanner Type	Flatbed
Photoelectric Device	CIS
Maximum Document Size	216×297 mm (8.5×11.7 in.) A4, Letter
Resolution	1200 dpi (main scan) 4800 dpi (sub scan)
Color Depth	<p>Color</p> <ul style="list-style-type: none"> <li><input type="checkbox"/> 48 bits per pixel internal (16 bits per pixel per color internal)</li> <li><input type="checkbox"/> 24 bits per pixel external (8 bits per pixel per color external)</li> </ul> <p>Grayscale</p> <ul style="list-style-type: none"> <li><input type="checkbox"/> 16 bits per pixel internal</li> <li><input type="checkbox"/> 8 bits per pixel external</li> </ul> <p>Black and white</p> <ul style="list-style-type: none"> <li><input type="checkbox"/> 16 bits per pixel internal</li> <li><input type="checkbox"/> 1 bits per pixel external</li> </ul>
Light Source	LED

## Appendix

## Interface Specifications

For Computer	Hi-Speed USB
For External USB Devices and PictBridge	Hi-Speed USB

## Network Function List

## Network Functions and IPv4/IPv6 Tables

Functions		Supported	Remarks	
Network Printing	EpsonNet Print (Windows)	IPv4	✓	-
	Standard TCP/IP (Windows)	IPv4, IPv6	✓	-
	WSD Printing (Windows)	IPv4, IPv6	✓	Windows Vista or later
	Bonjour Printing (Mac OS)	IPv4, IPv6	✓	-
	IPP Printing (Windows, Mac OS)	IPv4, IPv6	✓	-
	UPnP Printing	IPv4	-	Information appliance
	PictBridge Printing (Wi-Fi)	IPv4	✓	Digital camera
	Epson Connect (Email Print, Remote Print)	IPv4	✓	-
	AirPrint (iOS, Mac OS)	IPv4, IPv6	✓	iOS 5 or later, Mac OS X v10.7 or later
	Google Cloud Print	IPv4, IPv6	✓	-
Network Scanning	Epson Scan 2	IPv4, IPv6	✓	-
	Event Manager	IPv4	✓	-
	Epson Connect (Scan to Cloud)	IPv4	✓	-
	AirPrint (Scan)	IPv4, IPv6	✓	OS X Mavericks or later
	ADF (2-sided scanning)		-	-
Fax	Send a fax	IPv4	-	-
	Receive a fax	IPv4	-	-
	AirPrint (Faxout)	IPv4, IPv6	-	-

## Appendix

## Wi-Fi Specifications

Standards	IEEE802.11b/g/n* <sup>1</sup>
Frequency Range	2.4 GHz
Maximum Radio-Frequency Power Transmitted	20 dBm (EIRP)
Coordination Modes	Infrastructure, Wi-Fi Direct (Simple AP)* <sup>2*3</sup>
Wireless Securities* <sup>4</sup>	WEP (64/128bit), WPA2-PSK (AES)* <sup>5</sup>

\*1 IEEE802.11n is only available for the HT20.

\*2 Not supported for IEEE 802.11b.

\*3 Simple AP mode is compatible with a Wi-Fi connection (infrastructure).

\*4 Wi-Fi Direct supports WPA2-PSK (AES) only.

\*5 Complies with WPA2 standards with support for WPA/WPA2 Personal.

## Security Protocol

SSL/TLS	HTTPS Server/Client, IPPS
---------	---------------------------

## Supported Third Party Services

AirPrint	Print	iOS 5 or later/Mac OS X v10.7.x or later
	Scan	OS X Mavericks or later
Google Cloud Print		

## External Storage Device Specifications

### Supported Memory Card Specifications

Compatible Memory Cards	Maximum Capacities
miniSD*	2 GB
miniSDHC*	32 GB
microSD*	2 GB
microSDHC*	32 GB
microSDXC*	64 GB
SD	2 GB



## Appendix

Compatible Memory Cards	Maximum Capacities
SDHC	32 GB
SDXC	64 GB

\* Attach an adapter to fit the memory card slot. Otherwise, the card may get stuck.

## Supported External Storage Device Specifications

Compatible External Storage Devices	Maximum Capacities
CD-R Drive <sup>*1*2</sup> DVD-R Drive <sup>*1*2</sup> Blu-ray™ Drive <sup>*1*2</sup>	CD-ROM/CD-R: 700 MB DVD-ROM/DVD-R: 4.7 GB (CD-RW, DVD+R, DVD±RW, DVD-RAM, and Blu-ray Disc™ are not supported.)
MO Drive <sup>*1</sup>	1.3 GB
HDD <sup>*1</sup> USB Flash Drive	2 TB (formatted in FAT, FAT32, or exFAT)

\*1 We do not recommend using external USB devices that are powered by USB. Use only external USB devices with independent AC power sources.

\*2 Read only.

You cannot use the following devices:

- A device that requires a dedicated driver
- A device with security settings (password, encryption, and so on)
- A device with a built-in USB hub

Epson cannot guarantee operations for all externally connected devices.

## Supported Data Specifications

File Format	JPEGs (*.JPG) with the Exif Version 2.31 standard taken by digital cameras DCF <sup>*1</sup> Version 1.0 or 2.0 <sup>*2</sup> compliant
Image Size	Horizontal: 80 to 10200pixels Vertical: 80 to 10200pixels
File Size	Less than 2 GB
Maximum Number of Files	9990

\*1 Design rule for Camera File system.

\*2 Photo data stored in the built-in memory of a digital camera is not supported.

## Appendix

**Note:**

"!" is displayed on the LCD screen when the printer cannot recognize the image file. In this situation, if you select a multiple image layout, blank sections will be printed.

## Dimensions

Dimensions	<p>Storage</p> <ul style="list-style-type: none"> <li><input type="checkbox"/> Width: 349 mm (13.7 in.)</li> <li><input type="checkbox"/> Depth: 340 mm (13.4 in.)</li> <li><input type="checkbox"/> Height: 142 mm (5.6 in.)</li> </ul> <p>Printing</p> <ul style="list-style-type: none"> <li><input type="checkbox"/> Width: 349 mm (13.7 in.)</li> <li><input type="checkbox"/> Depth: 503 mm (19.8 in.)</li> <li><input type="checkbox"/> Height: 142 mm (5.6 in.)</li> </ul>
Weight*	Approx. 6.6 kg (14.6 lb)

\* : Without the ink cartridges, power cord, and the CD/DVD tray.

## Electrical Specifications

Model	100 to 240 V Model	100 to 120V Model
Rated Frequency Range	50 to 60 Hz	50 to 60 Hz
Rated Current	0.6 to 0.3 A	0.6A
Power Consumption (with USB Connection)	Standalone copying: Approx. 18 W (ISO/IEC24712) Ready mode: Approx. 6 W Sleep mode: Approx. 0.6 W Power off: Approx. 0.15 W	Standalone copying: Approx. 18 W (ISO/IEC24712) Ready mode: Approx. 6 W Sleep mode: Approx. 0.6 W Power off: Approx. 0.1 W

**Note:**

- Check the label on the printer for its voltage.
- For European users, see the following Website for details on power consumption.

<http://www.epson.eu/energy-consumption>

## Appendix

### Environmental Specifications

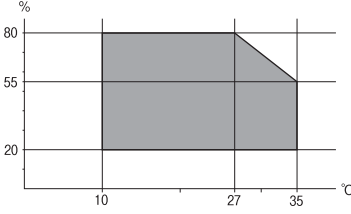
<p>Operation</p>	<p>Use the printer within the range shown in the following graph.</p>  <p>Temperature: 10 to 35°C (50 to 95°F) Humidity: 20 to 80% RH (without condensation)</p>
<p>Storage</p>	<p>Temperature: -20 to 40°C (-4 to 104°F)* Humidity: 5 to 85% RH (without condensation)</p>

\* You can store for one month at 40°C (104°F).

### Environmental Specifications for Ink Cartridges

<p>Storage Temperature</p>	<p>-30 to 40 °C (-22 to 104 °F)*</p>
<p>Freezing Temperature</p>	<p>-16 °C (3.2 °F) Ink thaws and is usable after approximately 3 hours at 25 °C (77 °F).</p>

\* You can store for one month at 40 °C (104 °F).

### System Requirements

- Windows 10 (32-bit, 64-bit)/Windows 8.1 (32-bit, 64-bit)/Windows 8 (32-bit, 64-bit)/Windows 7 (32-bit, 64-bit)/Windows Vista (32-bit, 64-bit)/Windows XP SP3 or later (32-bit)/Windows XP Professional x64 Edition SP2 or later
- macOS High Sierra/macOS Sierra/OS X El Capitan/OS X Yosemite/OS X Mavericks/OS X Mountain Lion/Mac OS X v10.7.x/Mac OS X v10.6.8

**Note:**

- Mac OS may not support some applications and features.*
- The UNIX File System (UFS) for Mac OS is not supported.*

# Regulatory Information

## Standards and Approvals

### Standards and Approvals for U.S. Model

Safety	UL60950-1 CAN/CSA-C22.2 No.60950-1
EMC	FCC Part 15 Subpart B Class B CAN/CSA-CEI/IEC CISPR 22 Class B

This equipment contains the following wireless module.

Manufacturer: Seiko Epson Corporation

Type: J26H006

This product conforms to Part 15 of the FCC Rules and RSS-210 of the IC Rules. Epson cannot accept responsibility for any failure to satisfy the protection requirements resulting from a non-recommended modification of the product. Operation is subject to the following two conditions: (1) this device may not cause harmful interference, and (2) this device must accept any interference received, including interference that may cause undesired operation of the device.

To prevent radio interference to the licensed service, this device is intended to be operated indoors and away from windows to provide maximum shielding. Equipment (or its transmit antenna) that is installed outdoors is subject to licensing.

This equipment complies with FCC/IC radiation exposure limits set forth for an uncontrolled environment and meets the FCC radio frequency (RF) Exposure Guidelines in Supplement C to OET65 and RSS-102 of the IC radio frequency (RF) Exposure rules. This equipment should be installed and operated so that the radiator is kept at least 7.9 inches (20 cm) or more away from a person's body (excluding extremities: hands, wrists, feet and ankles).

### Standards and Approvals for European Model

For European users

Hereby, Seiko Epson Corporation declares that the following radio equipment model is in compliance with Directive 2014/53/EU. The full text of the EU declaration of conformity is available at the following website.

<http://www.epson.eu/conformity>

C561E

For use only in Ireland, UK, Austria, Germany, Liechtenstein, Switzerland, France, Belgium, Luxemburg, Netherlands, Italy, Portugal, Spain, Denmark, Finland, Norway, Sweden, Iceland, Croatia, Cyprus, Greece, Slovenia, Malta, Bulgaria, Czech, Estonia, Hungary, Latvia, Lithuania, Poland, Romania, and Slovakia.

Epson cannot accept responsibility for any failure to satisfy the protection requirements resulting from a non-recommended modification of the products.



## Appendix

### Standards and Approvals for Australian Model

EMC	AS/NZS CISPR32 Class B
-----	------------------------

Epson hereby declares that the following equipment Models are in compliance with the essential requirements and other relevant provisions of AS/NZS4268:

C561E

Epson cannot accept responsibility for any failure to satisfy the protection requirements resulting from a non-recommended modification of the products.

### Restrictions on Copying

Observe the following restrictions to ensure the responsible and legal use of the printer.

Copying of the following items is prohibited by law:

- Bank bills, coins, government-issued marketable securities, government bond securities, and municipal securities
- Unused postage stamps, pre-stamped postcards, and other official postal items bearing valid postage
- Government-issued revenue stamps, and securities issued according to legal procedure

Exercise caution when copying the following items:

- Private marketable securities (stock certificates, negotiable notes, checks, etc.), monthly passes, concession tickets, etc.
- Passports, driver's licenses, warrants of fitness, road passes, food stamps, tickets, etc.

**Note:**

*Copying these items may also be prohibited by law.*

Responsible use of copyrighted materials:

Printers can be misused by improperly copying copyrighted materials. Unless acting on the advice of a knowledgeable attorney, be responsible and respectful by obtaining the permission of the copyright holder before copying published material.

---

## Transporting and Storing the Printer

When you need to store the printer or transport it when moving or for repairs, follow the steps below to pack the printer.



**Caution:**

*Be careful not to trap your hand or fingers when opening or closing the scanner unit. Otherwise you may be injured.*

## Appendix

**!** *Important:*

- ❑ *When storing or transporting the printer, avoid tilting it, placing it vertically, or turning it upside down; otherwise ink may leak.*
- ❑ *Leave the ink cartridges installed. Removing the cartridges can dry out the print head and may prevent the printer from printing.*
- ❑ *In the unlikely event that you need to remove the cartridge from the printer, make sure you put the cap on the cartridge's ink supply port; otherwise, the port will dry out and become unusable when you insert it back into the printer.*

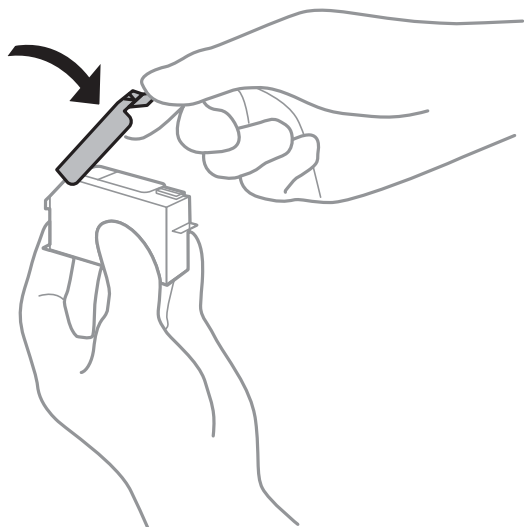

1. Turn off the printer by pressing the  button.
2. Make sure the power light turns off, and then unplug the power cord.

**!** *Important:*

*Unplug the power cord when the power light is off. Otherwise, the print head does not return to the home position causing the ink to dry, and printing may become impossible.*

3. Disconnect all cables such as the power cord and USB cable.
4. Make sure there is no memory card inserted.
5. Remove all of the paper from the printer.
6. Make sure there are no originals on the printer.

## Appendix

7. Open the scanner unit with the document cover closed.

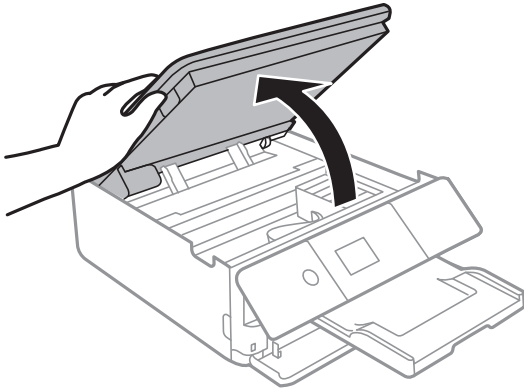

8. Secure the ink cartridge holder to the case by attaching the supplied protective material on top with tape.

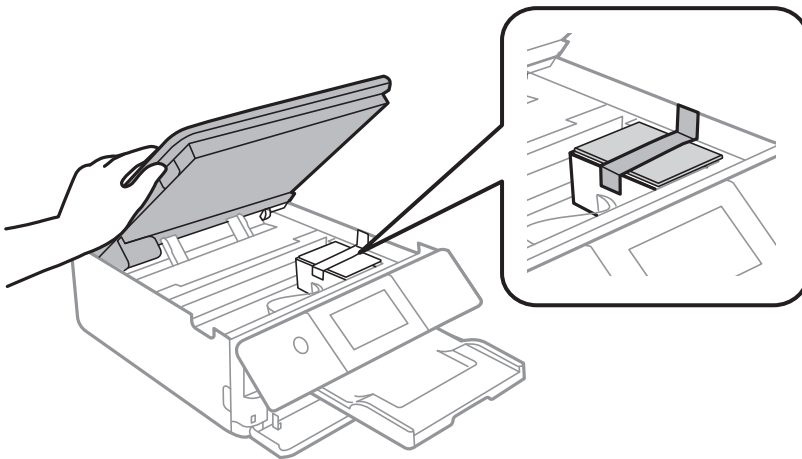

9. Close the scanner unit.

10. Prepare to pack the printer as shown below.

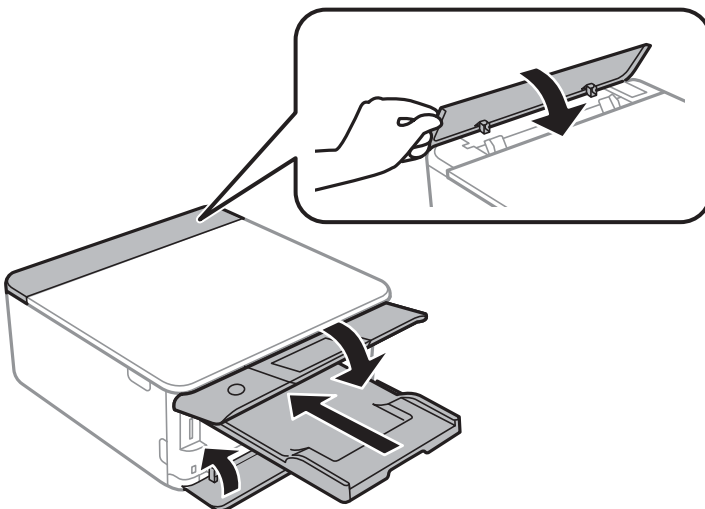

11. Pack the printer in its box, using the protective materials.

## Appendix

When you use the printer again, make sure you remove the tape securing the ink cartridge holder. If print quality has declined the next time you print, clean and align the print head.

### Related Information

- ➔ [“Part Names and Functions” on page 16](#)
- ➔ [“Checking and Cleaning the Print Head” on page 170](#)
- ➔ [“Aligning the Print Head” on page 171](#)

---

## Accessing a Memory Card From a Computer

You can write or read data on an external storage device such as a memory card that has been inserted in the printer from a computer.

### **Important:**

- Insert a memory card after removing write protection.
- If an image is saved to the memory card from a computer, the image and the number of photos are not refreshed on the LCD screen. Remove and insert the memory card again.
- When sharing an external device inserted in the printer between computers connected over USB and over a network, write access is only allowed to the computers that are connected by the method you selected on the printer. To write to the external storage device, select **Settings > File Sharing Setup** from the home screen, and then select a connection method.

### **Note:**

*It takes a while to recognize data from a computer if a large external storage device, such as 2TB HDD, is connected.*

### Windows

Select an external storage device in **Computer** or **My Computer**. The data on the external storage device is displayed.

### **Note:**

*If you connected the printer to the network without the software disc or Web Installer, map a memory card slot or USB port as a network drive. Open **Run** and enter a printer name \\XXXXX or a printer's IP address \\XXX.XXX.XXX.XXX to **Open**. Right-click a device icon displayed to assign the network. The network drive appears in **Computer** or **My Computer**.*

### Mac OS

Select a corresponding device icon. The data on the external storage device is displayed.

### **Note:**

- To remove an external storage device, drag and drop the device icon to the trash icon. Otherwise, data in the shared drive may not be displayed correctly when another external storage device is inserted.
- To access an external storage device through the network, select **Go > Connect to Server** from the menu on the desktop. Enter a printer name `cifs://XXXXX` or `smb://XXXXX` (Where "XXXXX" is the printer name) in the **Server Address**, and then click **Connect**.

### Related Information

- ➔ [“Inserting a Memory Card” on page 76](#)
- ➔ [“External Storage Device Specifications” on page 240](#)



---

## Where to Get Help

### Technical Support Web Site

If you need further help, visit the Epson support website shown below. Select your country or region and go to the support section of your local Epson website. The latest drivers, FAQs, manuals, or other downloadables are also available from the site.

<http://support.epson.net/>

<http://www.epson.eu/Support> (Europe)

If your Epson product is not operating properly and you cannot solve the problem, contact Epson support services for assistance.

### Contacting Epson Support

#### Before Contacting Epson

If your Epson product is not operating properly and you cannot solve the problem using the troubleshooting information in your product manuals, contact Epson support services for assistance. If Epson support for your area is not listed below, contact the dealer where you purchased your product.

Epson support will be able to help you much more quickly if you give them the following information:

- Product serial number  
(The serial number label is usually on the back of the product.)
- Product model
- Product software version  
(Click **About**, **Version Info**, or a similar button in the product software.)
- Brand and model of your computer
- Your computer operating system name and version
- Names and versions of the software applications you normally use with your product

**Note:**

*Depending on the product, network settings may be stored in the product's memory. Due to breakdown or repair of a product, settings may be lost. Epson shall not be responsible for the loss of any data, for backing up or recovering settings even during a warranty period. We recommend that you make your own backup data or take notes.*

#### Help for Users in Europe

Check your Pan-European Warranty Document for information on how to contact Epson support.

#### Help for Users in Australia

Epson Australia wishes to provide you with a high level of customer service. In addition to your product manuals, we provide the following sources for obtaining information:

## Appendix

### Internet URL

<http://www.epson.com.au>

Access the Epson Australia World Wide Web pages. Worth taking your modem here for the occasional surf! The site provides a download area for drivers, Epson contact points, new product information and technical support (e-mail).

### Epson Helpdesk

Phone: 1300-361-054

Epson Helpdesk is provided as a final backup to make sure our clients have access to advice. Operators on the Helpdesk can aid you in installing, configuring and operating your Epson product. Our Pre-sales Helpdesk staff can provide literature on new Epson products and advise where the nearest dealer or service agent is located. Many types of queries are answered here.

We encourage you to have all the relevant information on hand when you ring. The more information you prepare, the faster we can help solve the problem. This information includes your Epson product manuals, type of computer, operating system, application programs, and any information you feel is required.

### Transportation of Product

Epson recommends retaining product packaging for future transportation.

## Help for Users in New Zealand

Epson New Zealand wishes to provide you with a high level of customer service. In addition to your product documentation, we provide the following sources for obtaining information:

### Internet URL

<http://www.epson.co.nz>

Access the Epson New Zealand World Wide Web pages. Worth taking your modem here for the occasional surf! The site provides a download area for drivers, Epson contact points, new product information and technical support (e-mail).

### Epson Helpdesk

Phone: 0800 237 766

Epson Helpdesk is provided as a final backup to make sure our clients have access to advice. Operators on the Helpdesk can aid you in installing, configuring and operating your Epson product. Our Pre-sales Helpdesk staff can provide literature on new Epson products and advise where the nearest dealer or service agent is located. Many types of queries are answered here.

We encourage you to have all the relevant information on hand when you ring. The more information you prepare, the faster we can help solve the problem. This information includes your Epson product documentation, type of computer, operating system, application programs, and any information you feel is required.

### Transportation of Product

Epson recommends retaining product packaging for future transportation.