

User's Guide

Copyright

Copyright

No part of this publication may be reproduced, stored in a retrieval system, or transmitted in any form or by any means, electronic, mechanical, photocopying, recording, or otherwise, without the prior written permission of Seiko Epson Corporation. No patent liability is assumed with respect to the use of the information contained herein. Neither is any liability assumed for damages resulting from the use of the information herein. The information contained herein is designed only for use with this Epson product. Epson is not responsible for any use of this information as applied to other products.

Neither Seiko Epson Corporation nor its affiliates shall be liable to the purchaser of this product or third parties for damages, losses, costs, or expenses incurred by the purchaser or third parties as a result of accident, misuse, or abuse of this product or unauthorized modifications, repairs, or alterations to this product, or (excluding the U.S.) failure to strictly comply with Seiko Epson Corporation's operating and maintenance instructions.

Seiko Epson Corporation and its affiliates shall not be liable for any damages or problems arising from the use of any options or any consumable products other than those designated as Original Epson Products or Epson Approved Products by Seiko Epson Corporation.

Seiko Epson Corporation shall not be held liable for any damage resulting from electromagnetic interference that occurs from the use of any interface cables other than those designated as Epson Approved Products by Seiko Epson Corporation.

© 2014 Seiko Epson Corporation. All rights reserved.

The contents of this manual and the specifications of this product are subject to change without notice.

Trademarks

- ❑ EPSON® is a registered trademark, and EPSON EXCEED YOUR VISION or EXCEED YOUR VISION is a trademark of Seiko Epson Corporation.
- ❑ EPSON Scan software is based in part on the work of the Independent JPEG Group.
- ❑ libtiff
 - Copyright © 1988-1997 Sam Leffler
 - Copyright © 1991-1997 Silicon Graphics, Inc.
 - Permission to use, copy, modify, distribute, and sell this software and its documentation for any purpose is hereby granted without fee, provided that (i) the above copyright notices and this permission notice appear in all copies of the software and related documentation, and (ii) the names of Sam Leffler and Silicon Graphics may not be used in any advertising or publicity relating to the software without the specific, prior written permission of Sam Leffler and Silicon Graphics.
 - THE SOFTWARE IS PROVIDED "AS-IS" AND WITHOUT WARRANTY OF ANY KIND, EXPRESS, IMPLIED OR OTHERWISE, INCLUDING WITHOUT LIMITATION, ANY WARRANTY OF MERCHANTABILITY OR FITNESS FOR A PARTICULAR PURPOSE.
 - IN NO EVENT SHALL SAM LEFFLER OR SILICON GRAPHICS BE LIABLE FOR ANY SPECIAL, INCIDENTAL, INDIRECT OR CONSEQUENTIAL DAMAGES OF ANY KIND, OR ANY DAMAGES WHATSOEVER RESULTING FROM LOSS OF USE, DATA OR PROFITS, WHETHER OR NOT ADVISED OF THE POSSIBILITY OF DAMAGE, AND ON ANY THEORY OF LIABILITY, ARISING OUT OF OR IN CONNECTION WITH THE USE OR PERFORMANCE OF THIS SOFTWARE.
- ❑ Microsoft®, Windows®, and Windows Vista® are registered trademarks of Microsoft Corporation.
- ❑ Apple, Macintosh, Mac OS, OS X, Bonjour, Safari, iPad, iPhone, iPod touch, and iTunes are trademarks of Apple Inc., registered in the U.S. and other countries. AirPrint and the AirPrint logo are trademarks of Apple Inc.
- ❑ Google Cloud Print™, Chrome™, Chrome OS™, and Android™ are trademarks of Google Inc.
- ❑ Adobe, Adobe Reader, Acrobat, and Photoshop are trademarks of Adobe systems Incorporated, which may be registered in certain jurisdictions.
- ❑ Monotype is a trademark of Monotype Imaging, Inc. registered in the United States Patent and Trademark Office and may be registered in certain jurisdictions.
- ❑ Albertus, Arial, and Times New Roman are trademarks of The Monotype Corporation.
- ❑ ITC Avant Garde, ITC Bookman, ITC Zapf-Chancery, and ITC Zapf Dingbats are trademarks of International Typeface Corporation registered in the United States Patent and Trademark Office and may be registered in certain jurisdictions.
- ❑ Clarendon, Helvetica, New Century Schoolbook, Palatino, Times and Univers are registered trademarks of Heidelberger Druckmaschinen AG, which may be registered in certain jurisdictions, exclusively licensed through Linotype Library GmbH, a wholly owned subsidiary of Heidelberger Druckmaschinen AG.
- ❑ Wingdings is a registered trademark of Microsoft Corporation in the United States and other countries.
- ❑ Antique Olive is a registered trademark of Marcel Olive and may be registered in certain jurisdictions.
- ❑ Marigold is a trademark of AlphaOmega Typography.
- ❑ Coronet is a registered trademark of Ludlow Type Foundry.
- ❑ PCL is the registered trademark of Hewlett-Packard Company.

Trademarks

❑ Getopt

Copyright © 1987, 1993, 1994 The Regents of the University of California. All rights reserved.

Redistribution and use in source and binary forms, with or without modification, are permitted provided that the following conditions are met:

1. Redistributions of source code must retain the above copyright notice, this list of conditions and the following disclaimer.
2. Redistributions in binary form must reproduce the above copyright notice, this list of conditions and the following disclaimer in the documentation and/or other materials provided with the distribution.
4. Neither the name of the University nor the names of its contributors may be used to endorse or promote products derived from this software without specific prior written permission.

THIS SOFTWARE IS PROVIDED BY THE REGENTS AND CONTRIBUTORS "AS IS" AND ANY EXPRESS OR IMPLIED WARRANTIES, INCLUDING, BUT NOT LIMITED TO, THE IMPLIED WARRANTIES OF MERCHANTABILITY AND FITNESS FOR A PARTICULAR PURPOSE ARE DISCLAIMED. IN NO EVENT SHALL THE REGENTS OR CONTRIBUTORS BE LIABLE FOR ANY DIRECT, INDIRECT, INCIDENTAL, SPECIAL, EXEMPLARY, OR CONSEQUENTIAL DAMAGES (INCLUDING, BUT NOT LIMITED TO, PROCUREMENT OF SUBSTITUTE GOODS OR SERVICES; LOSS OF USE, DATA, OR PROFITS; OR BUSINESS INTERRUPTION) HOWEVER CAUSED AND ON ANY THEORY OF LIABILITY, WHETHER IN CONTRACT, STRICT LIABILITY, OR TORT (INCLUDING NEGLIGENCE OR OTHERWISE) ARISING IN ANY WAY OUT OF THE USE OF THIS SOFTWARE, EVEN IF ADVISED OF THE POSSIBILITY OF SUCH DAMAGE.

❑ Arcfour

This code illustrates a sample implementation of the Arcfour algorithm.

Copyright © April 29, 1997 Kalle Kaukonen. All Rights Reserved.

Redistribution and use in source and binary forms, with or without modification, are permitted provided that this copyright notice and disclaimer are retained.

THIS SOFTWARE IS PROVIDED BY KALLE KAUKONEN AND CONTRIBUTORS "AS IS" AND ANY EXPRESS OR IMPLIED WARRANTIES, INCLUDING, BUT NOT LIMITED TO, THE IMPLIED WARRANTIES OF MERCHANTABILITY AND FITNESS FOR A PARTICULAR PURPOSE ARE DISCLAIMED. IN NO EVENT SHALL KALLE KAUKONEN OR CONTRIBUTORS BE LIABLE FOR ANY DIRECT, INDIRECT, INCIDENTAL, SPECIAL, EXEMPLARY, OR CONSEQUENTIAL DAMAGES (INCLUDING, BUT NOT LIMITED TO, PROCUREMENT OF SUBSTITUTE GOODS OR SERVICES; LOSS OF USE, DATA, OR PROFITS; OR BUSINESS INTERRUPTION) HOWEVER CAUSED AND ON ANY THEORY OF LIABILITY, WHETHER IN CONTRACT, STRICT LIABILITY, OR TORT (INCLUDING NEGLIGENCE OR OTHERWISE) ARISING IN ANY WAY OUT OF THE USE OF THIS SOFTWARE, EVEN IF ADVISED OF THE POSSIBILITY OF SUCH DAMAGE.

❑ microSDHC Logo is a trademark of SD-3C, LLC.

Note: microSDHC is built into the product and cannot be removed.



❑ Intel® is a registered trademark of Intel Corporation.

❑ General Notice: Other product names used herein are for identification purposes only and may be trademarks of their respective owners. Epson disclaims any and all rights in those marks.

Contents

Copyright

Trademarks

About This Manual

Introduction of Manuals.	9
Marks and Symbols.	9
Descriptions Used in this Manual.	10
Operating System References.	10

Important Instructions

Safety Instructions.	11
Printer Advisories and Warnings.	11
Advisories and Warnings for Setting Up/ Using the Printer.	12
Advisories and Warnings for Using the Printer with a Wireless Connection.	13
Advisories and Warnings for Using the Touchscreen.	13
Protecting Your Personal Information.	13

Administrator Settings

Locking the Printer Settings Using an Administrator's Password.	14
Unlocking the Printer Settings.	14
User Feature Restrictions.	14

Printer Basics

Part Names and Functions.	16
Control Panel.	19
Buttons and Lights.	19
Icons Displayed on the LCD Screen.	20
Icons Displayed on the Software Keyboard of the LCD Screen.	21
Menu Options.	22
Copy Mode.	22
Scan Mode.	23
Fax Mode.	25
Memory Device Mode.	26
Setup Mode.	27
Contacts Mode.	36
Presets Mode.	37
Status Menu.	37

Loading Paper

Paper Handling Precautions.	38
Available Paper and Capacities.	39
List of Paper Types.	41
Loading Paper in the Paper Cassette.	41
Loading Paper in the Rear Paper Feed.	44

Placing Originals

Available Originals for the ADF.	47
Placing Originals on the ADF.	47
Placing Originals on the Scanner Glass.	49

Managing Contacts

Registering Contacts.	51
Registering Grouped Contacts.	51
Registration and Backup of Contacts Using a Computer.	52

Printing

Printing from the Control Panel.	53
Printing from a Computer.	53
Authenticating Users in the Printer Driver when User Feature Restriction Is Enabled (for Windows Only).	53
Printing Basics - Windows.	54
Printing Basics - Mac OS X.	55
Printing on 2-Sides.	57
Printing Several Pages on One Sheet.	59
Printing to Fit the Paper Size.	60
Printing Multiple Files Together (for Windows Only).	61
Enlarged Printing and Making Posters (for Windows Only).	62
Printing Using Advanced Features.	68
Printing Using a PostScript Printer Driver.	70
Printing Using a PostScript Printer Driver - Windows.	70
Printing Using a PostScript Printer Driver - Mac OS X.	72
Setting Items for the PostScript Printer Driver.	73
Printing from Smart Devices.	73
Using Epson iPrint.	73
Using AirPrint.	75
Canceling Printing.	76

Contents

Canceling Printing - Printer Button.	76
Canceling Printing - Status Menu.	76
Canceling Printing - Windows.	76
Canceling Printing - Mac OS X.	76

Copying

Scanning

Scanning Using the Control Panel.	79
Scanning to an Email.	79
Scanning to a Network Folder or FTP Server.	80
Scanning to a Memory Device.	81
Scanning to the Cloud.	81
Scanning Using Document Capture Pro (for Windows Only).	81
Scanning to a Computer (WSD).	82
Scanning from a Computer.	83
Authenticating Users when Using Access Control in EPSON Scan (for Windows Only).	83
Scanning in Office Mode.	83
Scanning in Professional Mode.	85
Scanning from Smart Devices.	87

Faxing

Setting Up a Fax.	89
Connecting to a Phone Line.	89
Making Basic Fax Settings.	92
Sending Faxes.	94
Basic Fax Sending Operations.	94
Various Ways of Sending Faxes.	96
Receiving Faxes.	100
Setting Receiving Mode.	100
Various Ways of Receiving Faxes.	101
Saving Received Faxes.	102
Forwarding Received Faxes.	104
Using Other Faxing Features.	105
Printing Fax Report and List.	105
Setting Security for Faxing.	106
Checking Fax Jobs.	106

Replacing Ink Cartridges and Other Consumables

Checking the Status of the Remaining Ink and the Maintenance Box.	108
Checking the Status of the Remaining Ink and the Maintenance Box - Control Panel.	108

Checking the Status of the Remaining Ink and the Maintenance Box - Windows.	108
Checking the Status of the Remaining Ink and the Maintenance Box - Mac OS X.	108
Ink Cartridge Codes.	109
Ink Cartridge Handling Precautions.	109
Replacing Ink Cartridges.	110
Maintenance Box Code.	112
Maintenance Box Handling Precautions.	112
Replacing a Maintenance Box.	113

Improving Print and Scan Quality

Checking and Cleaning the Print Head.	115
Checking and Cleaning the Print Head - Control Panel.	115
Checking and Cleaning the Print Head - Windows.	116
Checking and Cleaning the Print Head - Mac OS X.	116
Aligning the Print Head.	117
Aligning the Print Head - Control Panel.	117
Aligning the Print Head - Windows.	118
Aligning the Print Head - Mac OS X.	118
Cleaning the Paper Path for Ink Smears.	119
Cleaning the ADF.	119
Cleaning the Scanner Glass.	122

Applications and Network Service Information

Epson Connect Service.	123
Web Config.	123
Running Web Config on a Web Browser.	123
Running Web Config on Windows.	124
Running Web Config on Mac OS X.	124
Necessary Applications.	125
Windows Printer Driver.	125
Mac OS X Printer Driver.	126
EPSON Scan (Scanner Driver).	127
Document Capture Pro (for Windows Only).	128
PC-FAX Driver (Fax Driver).	128
FAX Utility.	128
E-Web Print (for Windows Only).	129
EPSON Software Updater.	129
EpsonNet Config.	129
Uninstalling Applications.	130
Uninstalling Applications - Windows.	130
Uninstalling Applications - Mac OS X.	131

Contents

Installing Applications.	131	Cannot Start Scanning.	155
Installing a PostScript Printer Driver.	132	Scanned Image Problems.	156
Installing the Epson Universal Printer Driver (for Windows Only).	134	Scan Quality Is Poor.	156
Updating Applications and Firmware.	135	Characters Are Blurred.	157
		An Image of the Reverse Side of the Original Appears in the Scanned Image.	157
Solving Problems		Moiré (Cross-Hatch) Patterns Appear in the Scanned Image.	157
Checking the Printer Status.	136	Scanning Area or Direction Is Not Correct.	157
Checking Messages on the LCD Screen.	136	The Scanned Image Problem Could Not be Cleared.	158
Error Code on the Status Menu.	137	Other Scanning Problems.	158
Checking the Printer Status - Windows.	142	Thumbnail Preview Does Not Work Properly.	158
Checking Printer Status - Mac OS X.	142	Scanning Is Too Slow.	158
Removing Jammed Paper.	142	Cannot Send the Scanned Image by Email.	159
Removing Jammed Paper from the Front Cover	142	Scanning Stops when Scanning to PDF/ Multi-TIFF.	159
Removing Jammed Paper from the Rear Paper Feed.	143	Problems when Sending and Receiving Faxes.	159
Removing Jammed Paper from the Paper Cassette.	144	Cannot Send or Receive Faxes.	159
Removing Jammed Paper from Rear Cover.	145	Cannot Send Faxes.	160
Removing Jammed Paper from the ADF.	145	Cannot Send Faxes to a Specific Recipient.	161
Paper Does Not Feed Correctly.	148	Cannot Send Faxes at a Specified Time.	161
Original Does Not Feed in the ADF.	149	Cannot Receive Faxes.	161
Power and Control Panel Problems.	149	Memory Full Error Occurs.	161
Power Does Not Turn On.	149	Sent Fax Quality Is Poor.	162
Power Does Not Turn Off.	149	Faxes Are Sent at the Wrong Size.	162
LCD Screen Gets Dark.	149	Received Fax Quality Is Poor.	163
Printer Does Not Print.	149	Received Faxes Are Not Printed.	163
Printout Problems.	150	Other Faxing Problems.	163
Print Quality Is Poor.	150	Cannot Make Calls on the Connected Telephone.	163
Copy Quality Is Poor.	151	Answering Machine Cannot Answer Voice Calls.	163
An Image of the Reverse Side of the Original Appears in the Copied Image.	152	Sender's Fax Number Not Displayed on Received Faxes or the Number Is Wrong.	164
The Position, Size, or Margins of the Printout Are Incorrect.	152	Cannot Forward Received Documents to Email Addresses.	164
Paper Is Smearred or Scuffed.	152	Other Problems.	164
Printed Characters Are Incorrect or Garbled.	153	Slight Electric Shock when Touching the Printer.	164
The Printed Image Is Inverted.	153	Operation Sounds Are Loud.	164
The Printout Problem Could Not be Cleared.	154	The Date and Time Are Incorrect.	164
Other Printing Problems.	154	Memory Device Is not Recognized.	165
Printing Is Too Slow.	154	Cannot Save Data to a Memory Device.	165
Printing Slows Down Dramatically During Continuous Printing.	154	Forgot Your Password.	165
PostScript Printer Driver Problems.	155	Application Is Blocked by a Firewall (for Windows Only).	165
Printer Does Not Print While Using PostScript Printer Driver.	155		
Printer Does Not Print Correctly While Using PostScript Printer Driver.	155	Appendix	
Printing Is Too Slow While Using PostScript Printer Driver.	155	Technical Specifications.	166

Contents

Printer Specifications.	166
Scanner Specifications.	166
Interface Specifications.	167
Fax Specifications.	167
Wi-Fi Specifications.	168
Ethernet Specifications.	168
Security Protocol.	168
Supported Third Party Services.	169
External USB Device Specifications.	169
Supported Data Specifications.	169
Dimensions.	170
Electrical Specifications.	170
Environmental Specifications.	171
System Requirements.	171
Font Information.	171
Available Fonts for PostScript.	171
Available Fonts for PCL.	173
List of Symbol Sets.	174
Regulatory Information.	179
Standards and Approvals for European Model.	179
German Blue Angel.	180
Restrictions on Copying.	180
Saving Power.	181
Saving Power - Control Panel.	181
Transporting the Printer.	181
Accessing an External USB Device From a Computer.	182
Installing the Optional Units.	183
Product Name of the Optional Paper Cassette Unit.	183
Installing the Optional Paper Cassette Units.	183
Using an Email Server.	184
Configuring an Email Server.	185
Email Server Setting Items.	186
Checking an Email Server Connection.	186
Where to Get Help.	186
Technical Support Web Site.	186
Contacting Epson Support.	187

About This Manual

Introduction of Manuals

The latest versions of the following manuals are available from the Epson support website.

<http://www.epson.eu/Support> (Europe)

<http://support.epson.net/> (outside Europe)

Important Safety Instructions (paper manual)

Provides you with instructions to ensure the safe use of this printer. This manual may not be included depending on model and region.

Start Here (paper manual)

Provides you with information on setting up the printer and installing the software.

User's Guide (PDF manual)

This manual. Provides overall information and instructions on using the printer, and on solving problems.

Network Guide (PDF manual)

Provides information on network settings and solving problems when using the printer on a network.

Administrator's Guide (PDF manual)

Provides network administrators with information on management and printer settings.

As well as the manuals above, check the various types of help information available from the printer itself or from the Epson applications.

Marks and Symbols



Caution:

Instructions that must be followed carefully to avoid bodily injury.



Important:

Instructions that must be observed to avoid damage to your equipment.

Note:

Provides complementary and reference information.

➔ Related Information

Links to related sections.

Descriptions Used in this Manual

- ❑ Screenshots of the printer driver and the EPSON Scan (scanner driver) screens are from Windows 8.1 or Mac OS X v10.9.x. The content displayed on the screens varies depending on the model and situation.
- ❑ Illustrations of the printer used in this manual are examples only. Although there may be slight differences depending on the model, the method of operation is the same.
- ❑ Some of the menu items on the LCD screen vary depending on the model and settings.

Operating System References

Windows

In this manual, terms such as "Windows 8.1", "Windows 8", "Windows 7", "Windows Vista", "Windows XP", "Windows Server 2012 R2", "Windows Server 2012", "Windows Server 2008 R2", "Windows Server 2008", "Windows Server 2003 R2", and "Windows Server 2003" refer to the following operating systems. Additionally, "Windows" is used to refer to all versions.

- ❑ Microsoft® Windows® 8.1 operating system
- ❑ Microsoft® Windows® 8 operating system
- ❑ Microsoft® Windows® 7 operating system
- ❑ Microsoft® Windows Vista® operating system
- ❑ Microsoft® Windows® XP operating system
- ❑ Microsoft® Windows® XP Professional x64 Edition operating system
- ❑ Microsoft® Windows Server® 2012 R2 operating system
- ❑ Microsoft® Windows Server® 2012 operating system
- ❑ Microsoft® Windows Server® 2008 R2 operating system
- ❑ Microsoft® Windows Server® 2008 operating system
- ❑ Microsoft® Windows Server® 2003 R2 operating system
- ❑ Microsoft® Windows Server® 2003 operating system

Mac OS X

In this manual, "Mac OS X v10.9.x" refers to "OS X Mavericks" and "Mac OS X v10.8.x" refers to "OS X Mountain Lion". Additionally, "Mac OS X" is used to refer to "Mac OS X v10.9.x", "Mac OS X v10.8.x", "Mac OS X v10.7.x" and "Mac OS X v10.6.8".

Important Instructions

Safety Instructions

Read and follow these instructions to ensure safe use of this printer. Make sure you keep this manual for future reference. Also, be sure to follow all warnings and instructions marked on the printer.



- Use only the power cord supplied with the printer and do not use the cord with any other equipment. Use of other cords with this printer or the use of the supplied power cord with other equipment may result in fire or electric shock.
- Be sure your AC power cord meets the relevant local safety standard.
- Never disassemble, modify, or attempt to repair the power cord, plug, printer unit, scanner unit, or options by yourself, except as specifically explained in the printer's manuals.
- Unplug the printer and refer servicing to qualified service personnel under the following conditions:
The power cord or plug is damaged; liquid has entered the printer; the printer has been dropped or the casing damaged; the printer does not operate normally or exhibits a distinct change in performance. Do not adjust controls that are not covered by the operating instructions.
- Place the printer near a wall outlet where the plug can be easily unplugged.
- Do not place or store the printer outdoors, near excessive dirt or dust, water, heat sources, or in locations subject to shocks, vibrations, high temperature or humidity.
- Take care not to spill liquid on the printer and not to handle the printer with wet hands.
- Keep the printer at least 22 cm away from cardiac pacemakers. Radio waves from this printer may adversely affect the operation of cardiac pacemakers.
- If the LCD screen is damaged, contact your dealer. If the liquid crystal solution gets on your hands, wash them thoroughly with soap and water. If the liquid crystal solution gets into your eyes, flush them immediately with water. If discomfort or vision problems remain after a thorough flushing, see a doctor immediately.
- Avoid using a telephone during an electrical storm. There may be a remote risk of electric shock from lightning.
- Do not use a telephone to report a gas leak in the vicinity of the leak.
- Be careful when you handle used ink cartridges, as there may be some ink around the ink supply port.
 - If ink gets on your skin, wash the area thoroughly with soap and water.
 - If ink gets into your eyes, flush them immediately with water. If discomfort or vision problems continue after a thorough flushing, see a doctor immediately.
 - If ink gets into your mouth, see a doctor right away.
- Do not disassemble the ink cartridge and the maintenance box; otherwise ink may get into your eyes or on your skin.
- Do not shake ink cartridges too vigorously; otherwise ink may leak from the cartridge.
- Keep ink cartridges and maintenance box out of the reach of children.

Printer Advisories and Warnings

Read and follow these instructions to avoid damaging the printer or your property. Make sure you keep this manual for future reference.

Important Instructions

Advisories and Warnings for Setting Up/Using the Printer

- Do not block or cover the vents and openings in the printer.
- Use only the type of power source indicated on the printer's label.
- Avoid using outlets on the same circuit as photocopiers or air control systems that regularly switch on and off.
- Avoid electrical outlets controlled by wall switches or automatic timers.
- Keep the entire computer system away from potential sources of electromagnetic interference, such as loudspeakers or the base units of cordless telephones.
- The power-supply cords should be placed to avoid abrasions, cuts, fraying, crimping, and kinking. Do not place objects on top of the power-supply cords and do not allow the power-supply cords to be stepped on or run over. Be particularly careful to keep all the power-supply cords straight at the ends and the points where they enter and leave the transformer.
- If you use an extension cord with the printer, make sure that the total ampere rating of the devices plugged into the extension cord does not exceed the cord's ampere rating. Also, make sure that the total ampere rating of all devices plugged into the wall outlet does not exceed the wall outlet's ampere rating.
- If you plan to use the printer in Germany, the building installation must be protected by a 10 or 16 amp circuit breaker to provide adequate short-circuit protection and over-current protection for the printer.
- When connecting the printer to a computer or other device with a cable, ensure the correct orientation of the connectors. Each connector has only one correct orientation. Inserting a connector in the wrong orientation may damage both devices connected by the cable.
- Place the printer on a flat, stable surface that extends beyond the base of the printer in all directions. The printer will not operate properly if it is tilted at an angle.
- When storing or transporting the printer, avoid tilting it, placing it vertically, or turning it upside down; otherwise ink may leak.
- Allow space above the printer so that you can fully raise the document cover.
- Leave enough space in front of the printer for the paper to be fully ejected.
- Avoid places subject to rapid changes in temperature and humidity. Also, keep the printer away from direct sunlight, strong light, or heat sources.
- Do not insert objects through the slots in the printer.
- Do not put your hand inside the printer during printing.
- Do not touch the white flat cable inside the printer.
- Do not use aerosol products that contain flammable gases inside or around the printer. Doing so may cause fire.
- Do not move the print head by hand; otherwise, you may damage the printer.
- Be careful not to trap your fingers when closing the document cover.
- Do not press too hard on the scanner glass when placing the originals.
- Always turn the printer off using the  button. Do not unplug the printer or turn off the power at the outlet until the  light stops flashing.
- Before transporting the printer, make sure that the print head is in the home (far right) position and the ink cartridges are in place.
- If you are not going to use the printer for a long period, be sure to unplug the power cord from the electrical outlet.

Important Instructions

Advisories and Warnings for Using the Printer with a Wireless Connection

- ❑ Radio waves from this printer may negatively affect the operation of medical electronic equipment, causing them to malfunction. When using this printer inside medical facilities or near medical equipment, follow directions from the authorized personnel representing the medical facilities, and follow all posted warnings and directions on the medical equipment.
- ❑ Radio waves from this printer may negatively affect the operation of automatically controlled devices such as automatic doors or fire alarms, and could lead to accidents due to malfunction. When using this printer near automatically controlled devices, follow all posted warnings and directions on these devices.

Advisories and Warnings for Using the Touchscreen

- ❑ The LCD screen may contain a few small bright or dark spots, and because of its features it may have an uneven brightness. These are normal and do not indicate that it is damaged in any way.
- ❑ Only use a dry, soft cloth for cleaning. Do not use liquid or chemical cleaners.
- ❑ The exterior cover of the touchscreen could break if it receives a heavy impact. Contact your dealer if the panel surface chips or cracks, and do not touch or attempt to remove the broken pieces.
- ❑ Press the touchscreen gently with your finger. Do not press force or operate with your nails.
- ❑ Do not use sharp objects such as ball point pens or sharp pencils to perform operations.
- ❑ Condensation inside the touchscreen due to abrupt changes in temperature or humidity may cause performance to deteriorate.

Protecting Your Personal Information

When you give the printer to someone else or dispose of it, erase all the personal information stored in the printer's memory by selecting **Setup > System Administration > Restore Default Settings > Clear All Data and Settings** on the control panel.

Administrator Settings

Locking the Printer Settings Using an Administrator's Password

You can set an administrator's password to lock the printer settings so that they cannot be changed by other users. You can lock the following settings.

- System Administration
- Eco Mode
- Presets
- Contacts

You cannot change settings without entering the password. This password is also required when you make settings using Web Config or EpsonNet Config.

**Important:**

Do not forget the password. If you forget the password, contact Epson support.

1. Enter **Setup** from the home screen.
2. Select **Admin Settings > Admin Password**.
3. Select **Register**, and then enter a password.
4. Enter the password again.
5. Select **Lock Setting**, and then enable it.

Unlocking the Printer Settings

1. Enter **Setup** from the home screen.
2. Select **Admin Settings**.
3. Enter the administrator's password.
4. Select **Lock Setting**, and then disable it.

User Feature Restrictions

Note:

Mac OS X is not supported.

The administrator can restrict printer features for individual users. To use a restricted feature, the user has to enter an ID and password on the control panel. Use this feature to prevent misuse of the printer.

Administrator Settings

Use Web Config to configure restriction settings on a computer. See the *Administrator's Guide* for more details.

After configuring settings on the computer, enable the user restriction feature on the printer. Select **Setup > System Administration > Security Settings > Access Control** from the home screen, and then enable it.

Printer Basics

Part Names and Functions

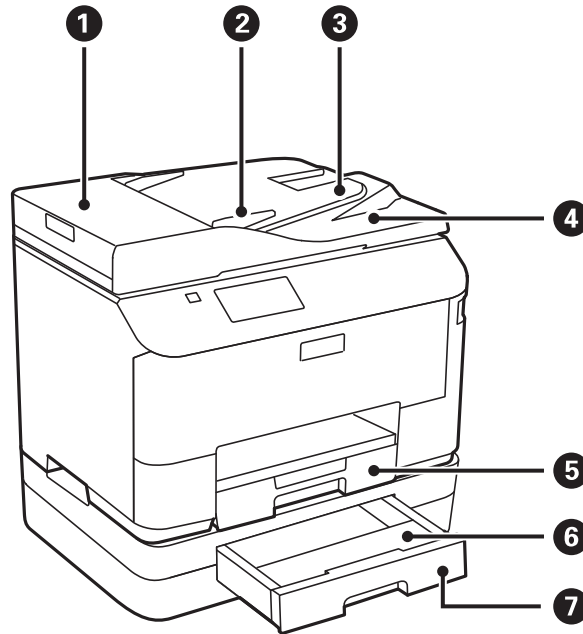

①	ADF (Automatic Document Feeder) cover	Open when removing jammed originals in the ADF.
②	Edge guides	Feeds originals straight into the printer. Slide to the edges of the originals.
③	ADF input tray	Feeds originals automatically.
④	ADF output tray	Holds originals ejected from the ADF.
⑤	Paper cassette	Loads paper.
⑥	Paper cassette cover	Attach to paper cassette 2.
⑦	Paper cassette 2	Optional paper cassette units. Loads paper.

Printer Basics

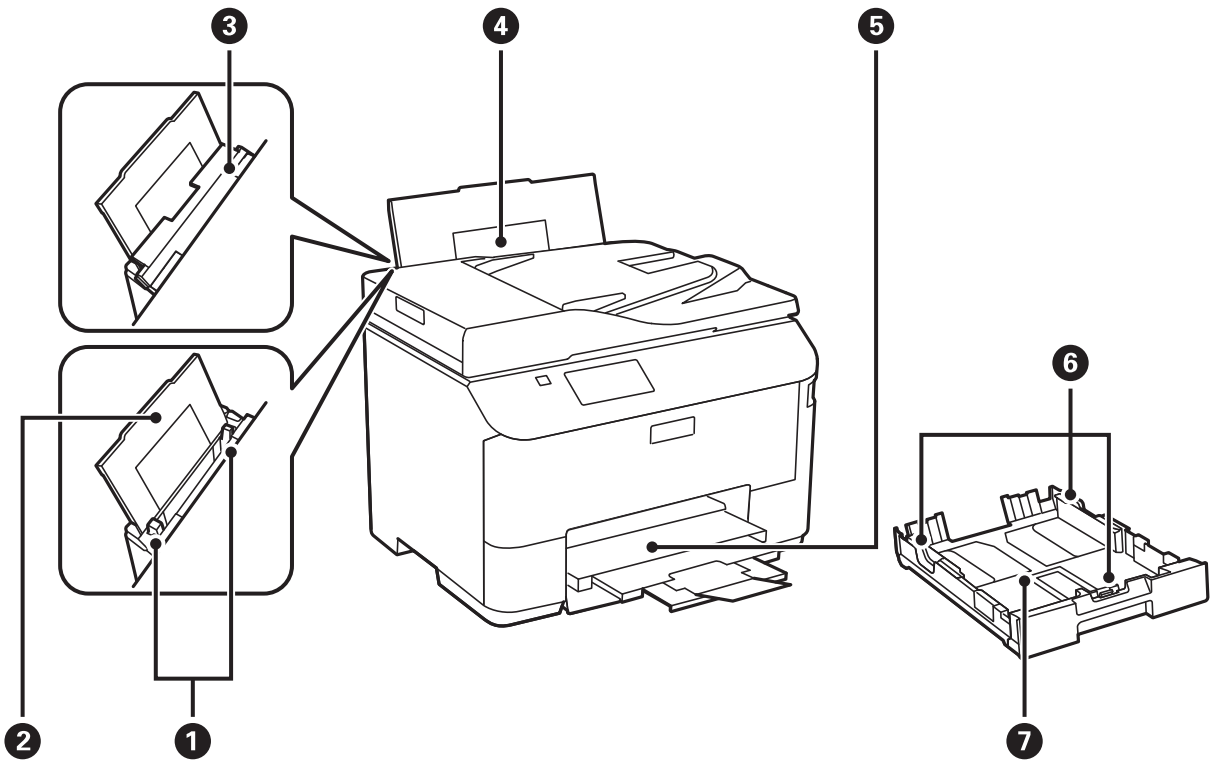

①	Edge guides	Feeds the paper straight into the printer. Slide to the edges of the paper.
②	Paper support	Supports loaded paper.
③	Feeder guard	Prevents foreign substance from entering the printer. Usually keep this guard closed.
④	Rear paper feed	Loads paper.
⑤	Output tray	Holds the ejected paper.
⑥	Edge guides	Feeds the paper straight into the printer. Slide to the edges of the paper.
⑦	Paper cassette	Loads paper.

Printer Basics

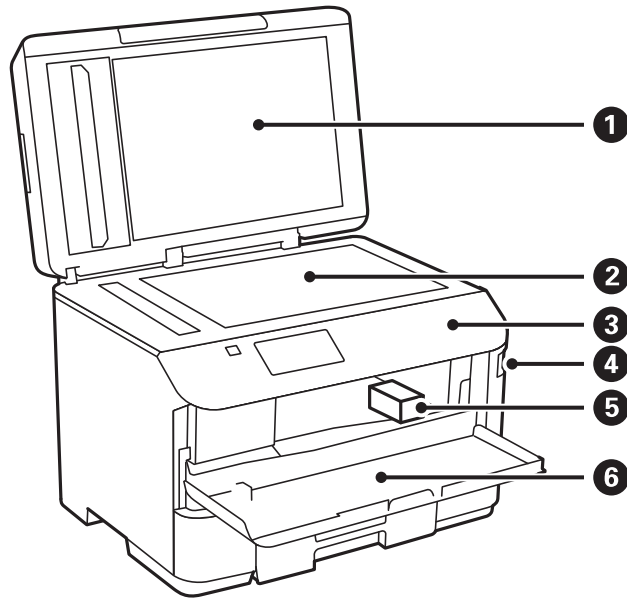

①	Document cover	Blocks external light while scanning.
②	Scanner glass	Scans placed originals.
③	Control panel	Operates the printer.
④	External interface USB port	Connects memory devices.
⑤	Print head	Fires ink.
⑥	Front cover	Open when replacing an ink cartridge and removing jammed paper inside the printer.

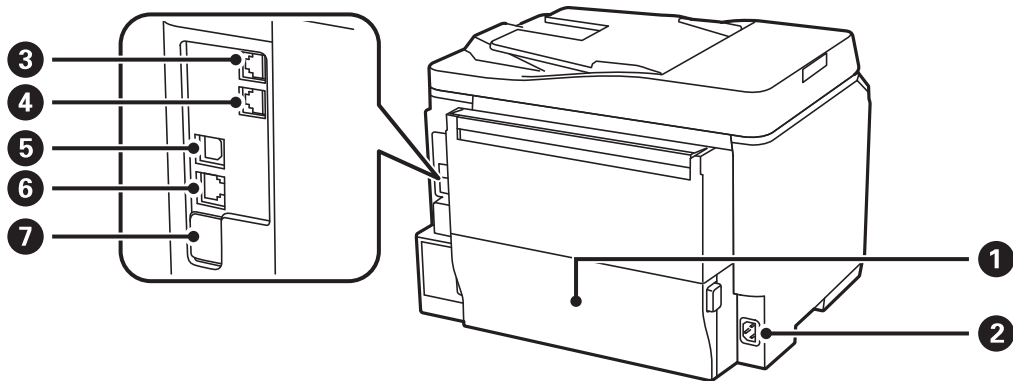

①	Rear cover	Pull out when replacing the maintenance box and removing jammed paper.
②	AC inlet	Connects the power cord.

Printer Basics

3	LINE port	Connects a phone line.
4	EXT. port	Connects external phone devices.
5	USB port	Connects a USB cable.
6	LAN port	Connects a LAN cable.
7	Service USB port	USB port for future use. Do not remove the sticker.

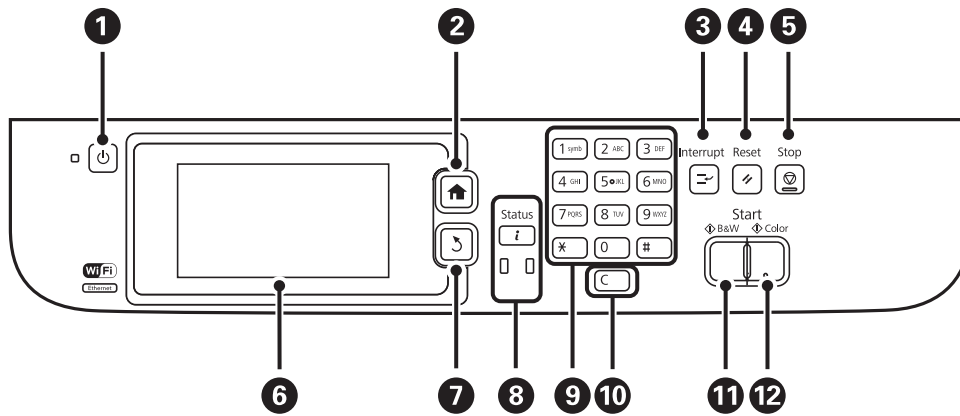

Control Panel

Buttons and Lights

















1		Turns the printer on or off. Unplug the power cord when the power light is off.
2		Displays the home screen.
3		Pauses the current job and allows you to interrupt another job. Press this button again to restart a paused job.
4		Returns the current settings to their previous status.
5		Stops the current operation.
6	-	Displays menus and messages. Touch the LCD screen to select a menu, and scroll by swiping.
7		Returns to the previous screen.
8		Displays the Status Menu . You can check the printer's status and job history. The error light on the left flashes or turns on when an error occurs. The data light on the right flashes when the printer is processing data. It turns on when there are queued jobs.
9	0 - 9 *, #	Enters numbers, characters, and symbols.
10	c	Clears number settings such as the number of copies.

Printer Basics



11		Starts printing, copying, scanning, and sending a fax in black and white.
12		Starts scanning and sending a fax in color.

Icons Displayed on the LCD Screen

The following icons are displayed on the LCD screen depending on the printer's status. Press the network icon to check the current network settings and make Wi-Fi settings.

	Press this icon to view operating instructions such as how to load paper, and how to place originals.
	Turns on when originals are placed in the ADF.
	Turns on when ink is running low or the maintenance box is nearly full. Press the i button, and then select Printer Information to check the status.
	Turns on when ink is expended or the maintenance box is full. Press the i button, and then select Printer Information to check the status.
	Turns on when received documents that have not yet been read, printed, or saved, are stored in the product's memory.
	Indicates fax memory usage.
	Indicates that the fax memory is full. Delete unnecessary documents from the inbox.
	Indicates that the printer is connecting to a wireless (Wi-Fi) or wired (Ethernet) network.
	Turns on while the printer is connected to a wired (Ethernet) network.
	Turns on while the printer is connected to a wireless (Wi-Fi) network. The number of bars indicates the signal strength of the connection. The more bars there are, the stronger the connection.
	Indicates a problem with the printer's wireless (Wi-Fi) network connection, or that the printer is searching for a wireless (Wi-Fi) network connection.
	Indicates that the printer is connected to a wireless (Wi-Fi) network in Ad Hoc mode.
	Indicates that the printer is connected to a wireless (Wi-Fi) network in Wi-Fi Direct mode.
	Indicates that the printer is connected to a wireless (Wi-Fi) network in Simple AP mode.

Printer Basics

	<p>Indicates that the user restriction feature is enabled. Press this icon to log in to the printer. You need to enter a user name and password. Contact your printer administrator for login information.</p>
	<p>Indicates that a user with access permission has logged in.</p>

Related Information









➔ [“Memory Full Error Occurs” on page 161](#)

Icons Displayed on the Software Keyboard of the LCD Screen

You can enter characters and symbols by using the software keyboard screen when you register a contact, make network settings, and so on. The following icons are displayed on the software keyboard screen.

Note:

Available icons vary depending on the setting item.



	<p>Switches between upper case and lower case.</p>
  	<p>Switches the character type.</p> <p>123#: Enters numbers and symbols.</p> <p>ABC: Enters letters.</p> <p>AAA: Enters special characters such as umlauts and accents.</p>
	<p>Changes the keyboard layout.</p>
	<p>Enters a space.</p>
	<p>Deletes a character to the left.</p>
	<p>Enters a character.</p>
	<p>Enters a pause (pauses for three seconds) while dialing. A hyphen (-) is entered as the pause mark.</p>

Menu Options

Copy Mode

Note:

- Available menus vary depending on the layout you selected.
- Press **Settings** to display hidden setting menus.

Menu	Settings and Explanations	
Number of copies	Enter the number of copies.	
Layout	With Border	Copies with a border around the edges.
	2-up	Copies multiple page originals onto one sheet.
	4-up	<p>When placing originals in the ADF, insert them into the feeder from the top or left edge.</p> <p>Load vertical originals as shown below, and select Portrait from Document Orientation.</p>  <p>Load vertical originals as shown below, and select Landscape from Document Orientation.</p> 
	ID Card	Scans both sides of an ID card and copies onto one side of A4 size paper.
Document Size	Select the size of your original.	
Zoom	<p>Enlarges or reduces the original.</p> <p>Select Auto Fit Page to fit to the paper size of the selected paper source.</p>	
Paper Source	<p>Select the paper source that you want to use.</p> <p>Feeds paper automatically using the Paper Setup settings made when you loaded the paper.</p> <p>Select the paper size and paper type you loaded when Rear Paper Feed is selected.</p>	
2-Sided	<p>Select 2-sided layout.</p> <p>Select a layout, press Advanced, and then select the binding position of your original and the paper.</p>	
Document Orientation	Select the orientation of your original.	
Quality	<p>Select the type of your original.</p> <p>Text: Provides faster printing, but the printouts may be faint.</p> <p>Photo: Provides higher quality printing, but the printing speed may be slower.</p>	
Density	Set the density of your copies.	

Printer Basics

Menu	Settings and Explanations
Layout Order	Select the copy layout for multiple pages when you have selected 2-up or 4-up as the Layout setting.
Remove Shadow	Removes shadows that appear in the center of copies when copying a booklet or that appear around copies when copying thick paper.
Remove Punch Holes	Removes the binding holes when copying.
Collate Copy	Prints multiple copies of multiple originals collated in order and sorts them into sets.
Dry Time	Select the drying time.
Advanced Settings	Adjust image settings such as contrast and sharpness.

Scan Mode

Email

Menu	Settings and Explanations
Contacts	Select email addresses to send the scanned image from the contacts list.
Format	Select the format in which to save the scanned image. When you select TIFF (Single Page) or TIFF (Multi Page) , only monochrome scanning is available.
Menu	Email Settings Subject: Enter a subject for the email. Filename Prefix: Enter a prefix for the name of the file to be sent.
	Basic Settings See the list of menus in Settings .
	Scan Report Prints a history that shows when and to which email address scanned files have been sent.

Network Folder/FTP

Menu	Settings and Explanations
Contacts	Select a folder in which to save the scanned image from the contact list. You do not need to make location settings when you have selected a folder from the contacts list.
Location	Communication Mode Select the communication mode.
	Location Enter a folder path in which to save the scanned image.
	User Name Enter a user name for the specified folder.
	Password Enter a password for the specified folder.
	Connection Mode Select the connection mode.
	Port Number Enter a port number.
Format	Select the format in which to save the scanned image. When you select TIFF (Single Page) , only monochrome scanning is available.

Printer Basics

Menu	Settings and Explanations	
Menu	File Settings	Enter a prefix for the file name in Filename Prefix .
	Basic Settings	See the list of menus in Settings .
	Scan Report	Prints a history that shows when and to which folder the scanned files have been sent.

Memory Device

Menu	Settings and Explanations
Format	Select the format in which to save the scanned image. When you select TIFF (Multi Page) , only monochrome scanning is available.
Settings	See the list of menus in Settings .

Cloud

Menu	Settings and Explanations
Format	Select the format in which to save the scanned image.
Settings	See the list of menus in Settings .

Document Capture Pro

This menu has no setting item.

Computer (WSD)

This menu has no setting item.

Settings

Note:

Available menus vary depending on the destination type, such as email or folder, and the format in which scanned images are saved.

Menu	Settings and Explanations
Resolution	Select the scanning resolution.
Scan Area	Select the scan area. Auto Cropping: Crops the white space around the text or image when scanning. Max Area: Scans at the maximum scan area of the scanner glass or the ADF.
2-Sided	Scans both sides of the original. When performing 2-sided scanning, select Binding Direction and then select the binding position of the original.
Document Type	Select the type of your original.
Density	Select the contrast of the scanned image.

Printer Basics

Menu	Settings and Explanations
Document Orientation	Select the orientation of your original.
Compression Ratio	Select how much to compress the scanned image.
PDF Settings	When you have selected PDF as the save format setting, use these settings to protect PDF files. Document Open Password: Creates a PDF file that requires a password when opening. Permissions Password: Creates a PDF file that requires a password when printing or editing.
Attached File Max Size	Select the maximum file size that can be attached to the email.

Fax Mode

From the home screen, select **Fax > Menu**. You can access some of the setting menus directly from the **Fax** screen.

Menu	Settings and Explanations	
Fax Send Settings	Resolution	Select the resolution of the outgoing fax. Select Photo for originals that contain both text and photo images.
	Density	Set the density of the outgoing fax.
	Document Size (Glass)	Select the size and orientation of the original you placed on the scanner glass.
	ADF 2-Sided	When sending a monochrome fax, both sides of the original placed in the ADF are scanned.
	Direct Send	See the pages that describe these features for more details.
	Priority Send	
	Continuous Scan from ADF	
	Transmission Report	Prints a transmission report automatically after you send a fax. Select Print on Error to print a report only when an error occurs.
Send Fax Later	See the pages that describe these features for more details.	
Polling Receive		
Polling Send		
Store Fax Data		

Printer Basics

Menu	Settings and Explanations	
Fax Report	Fax Settings List	Prints the current fax settings.
	Fax Log	Prints a transmission report automatically after you send a fax. You can set to print this report automatically using the following menu. Setup > System Administration > Fax Settings > Output Settings > Fax Log Auto Print
	Last Transmission	Prints a report for the previous fax that was sent or received through polling.
	Stored Fax Documents	Prints a list of fax documents stored in the printer's memory, such as unfinished jobs.
	Protocol Trace	Prints a detailed report for the previous fax that was sent or received.

Related Information

- ➔ [“Sending Many Pages of a Monochrome Document \(Direct Send\)” on page 98](#)
- ➔ [“Sending a Fax Preferentially \(Priority Send\)” on page 99](#)
- ➔ [“Sending Different Size Documents Using ADF \(Continuous Scan from ADF\)” on page 99](#)
- ➔ [“Sending Faxes at a Specified Time \(Send Fax Later\)” on page 97](#)
- ➔ [“Receiving Faxes by Polling \(Polling Receive\)” on page 102](#)
- ➔ [“Sending Faxes on Demand \(Polling Send\)” on page 98](#)
- ➔ [“Storing a Fax Without Specifying a Recipient \(Store Fax Data\)” on page 97](#)

Memory Device Mode

Note:

Memory device is a generic name for external USB devices such as USB flash drives.

File format

Menu	Settings and Explanations
JPEG	Select the file format of the file you want to print.
TIFF	
PDF	

Settings

Note:

Available menus vary depending on the selected file format.

Menu	Settings and Explanations
Number of printouts	Enter the number of printouts.

Printer Basics

Menu	Settings and Explanations	
Settings	Paper Source	Select the paper source that you want to use.
	Quality	Select the print quality. If you select Best , the printing speed may be slower.
	Date	Select the format of the date on the printouts.
	Fit Frame	Crops the top and bottom edges of the image to fit in the selected paper size. Turning this off causes margins to appear on the left and right side of the image.
	Bidirectional	Select which side to fire ink when the print head moves. Turn this on under normal usage. Enabled: Prints when the print head moves in both directions. Disabled: Prints only when the print head moves in one direction. Print quality improves, but the printing speed is slow.
	2-Sided	Select 2-sided layout.
	Print Order	Last Page on Top: Prints from the first page of a file. First Page on Top: Prints from the last page of a file.
Image Adjustments	Fix Photo	Select the image correction method. On: Enhances the image automatically by using Epson's unique image analysis and image processing technology. P.I.M.: Adjusts the image by using your camera's PRINT Image Matching or Exif Print information.
	Fix Red-Eye	Fixes red-eye in photos. Corrections are not applied to the original file, only to the printouts. Depending on the type of photo, parts of the image other than the eyes may be corrected.
Options	Select Images	Select All Images selects all of the images on the memory device.
	Select Group	Select this menu to select another group.

Setup Mode

Menu	Settings and Explanations
Ink Level	Displays the approximate levels of the ink and the maintenance box. When an ! icon is displayed, the ink is running low or the maintenance box is nearly full. When a x icon is displayed, the ink is expended or the maintenance box is full.

Printer Basics

Menu	Settings and Explanations	
Maintenance	Print Head Nozzle Check	Prints a pattern to check if the print head nozzles are clogged.
	Print Head Cleaning	Cleans clogged nozzles in the print head.
	Print Head Alignment	Adjusts the print head to improve print quality. Run Vertical Alignment if your printouts look blurry. Run Horizontal Alignment if your printouts contain horizontal banding at regular intervals. Run Ruled Line Alignment if text and lines are misaligned.
	Thick Paper	Reduces ink smearing when printing. Enable this feature only when you see ink smearing on your printouts because it may lower the printing speed.
	Paper Guide Cleaning	Use this feature to feed paper for cleaning when there are ink stains on the internal rollers.
Paper Setup	Select the paper size and paper type you loaded in each paper source.	
Print Status Sheet	Configuration Status Sheet	Prints an information sheet showing the current printer status and settings.
	Supply Status Sheet	Prints an information sheet showing the status of consumables.
	Usage History Sheet	Prints an information sheet showing the usage history of the printer.
	PS3 Font List	Prints a list of fonts that are available for a PostScript printer.
	PCL Font List	Prints a list of fonts that are available for a PCL printer.
Network Status	Wi-Fi/Network Status	Displays or prints the current network settings.
	Wi-Fi Direct Status	
	Email Server Status	Displays the current email server settings.
	Epson Connect Status	Displays whether or not the printer is registered and connected to Epson Connect or Google Cloud Print service.
	Google Cloud Print Status	See the Epson Connect portal website for more details. https://www.epsonconnect.com/ http://www.epsonconnect.eu (Europe only)
Admin Settings	These menus allow an administrator to register an administrator password to protect the printer settings from being changed by other users.	
	Admin Password	Set, change, or reset the administrator password. If you forget the password, contact your dealer.
	Lock Setting	You need to enter an administrator password when you enter the System Administration settings and when you change the settings of Eco Mode , Presets , and the contacts.
System Administration	See the pages that describe these features for more details.	

Printer Basics

Related Information

➔ [“System Administration” on page 29](#)

System Administration

Select **Setup** on the home screen, and then select **System Administration**.

Menu	Settings and Explanations		
Printer Settings	See the list of menus in Printer Settings .		
Common Settings	LCD Brightness	Adjust the brightness of the LCD screen.	
	Sound	Adjust the volume and select the type of audio.	
	Sleep Timer	Select the time period before the printer enters sleep mode (energy saving mode) when no operations are performed. The LCD screen turns black when the set time passes.	
	Power Off Timer	You can adjust the time before power management is applied. Any increase will affect the product's energy efficiency. Please consider the environment before making any change.	
	Date/Time Settings	Date/Time	Enter the current date and time.
		Daylight Saving Time	Select the summer time setting that applies to your area.
		Time Difference	Enter the time difference between your local time and UTC (Coordinated Universal Time).
	Country/Region	Select the country or region.	
	Language	Select the display language.	
	Operation Time Out	If this feature is enabled, the LCD screen returns to the home screen when no operations have been performed for about three minutes. This feature is automatically enabled when the user restriction feature is enabled.	

Printer Basics

Menu	Settings and Explanations		
Wi-Fi/Network Settings	Wi-Fi/Network Status	Displays or prints the network settings and connection status.	
	Wi-Fi Setup	Wi-Fi Setup Wizard	See the <i>Network Guide</i> for more details.
		Push Button Setup (WPS)	
		PIN Code Setup (WPS)	
		Wi-Fi Auto Connect	
	Disable Wi-Fi	You may be able to resolve network problems by disabling the Wi-Fi settings or making the Wi-Fi settings again. See the <i>Network Guide</i> for more details.	
	Wi-Fi Direct Setup	See the <i>Network Guide</i> for more details.	
Connection Check	Checks the status of the network connection and prints the network connection check report. If there are any problems with the connection, see the check report to solve the problem.		
Advanced Setup	See the <i>Network Guide</i> for more details.		
Epson Connect Services	You can suspend or resume the Epson Connect or Google Cloud Print service, or cancel using the services (restore the default settings).		
Google Cloud Print Services	See the Epson Connect portal website for more details. https://www.epsonconnect.com/ http://www.epsonconnect.eu (Europe only)		
Copy Settings	The settings made in the User Default Settings are displayed as the default settings in each mode. For details on the setting items, see the list of menus for each mode.		
Scan Settings			
Fax Settings	See the list of menus in Fax Settings .		
Universal Print Settings	These print settings are applied when printing from an external device without using the printer driver, or when printing from a PostScript printer driver or PCL printer driver.		
	Top Offset	Adjust the top or left margin of the paper.	
	Left Offset		
	Top Offset in Back	Adjust the top margin or left margin for the back of the page when performing 2-sided printing.	
	Left Offset in Back		
	Check Paper Width	Checks the paper width before the printer starts printing. This prevents printing beyond the edges of the paper when the paper size setting is not correct, but the printing time may be little longer.	
	Dry Time	Select the drying time when performing 2-sided printing.	
	Skip Blank Page	Skips blank pages in the print data automatically.	
PDL Print Configuration	See the list of menus in PDL Print Configuration .		

Printer Basics

Menu	Settings and Explanations		
Security Settings	Access Control	Requires the administrator password to operate the printer. Select whether or not to allow jobs that do not have the necessary authentication information.	
	Delete All Confidential Jobs	Deletes all saved confidential jobs.	
Eco Mode	The following Eco mode settings are available. When these settings are disabled, the settings made in Common Settings are applied.		
	Configure	Sleep Timer	Select the time period before the printer enters sleep mode (energy saving mode) when no operations are performed. The LCD screen turns black when the set time passes.
		LCD Brightness	Adjust the brightness of the LCD screen.
		2-Sided (Copy)	Sets 2-sided copying as the default setting.
		2-Sided (Memory Device)	Sets 2-sided printing as the default setting.
Clear Internal Memory Data	Deletes the print settings for a PostScript printer driver and a PCL printer driver. Select Clear All to delete all of the data for a PostScript printer driver and a PCL printer driver that is saved in the printer's memory.		
Restore Default Settings	Resets the selected settings to their defaults.		

Related Information

- ➔ [“Copy Mode” on page 22](#)
- ➔ [“Scan Mode” on page 23](#)
- ➔ [“Fax Settings” on page 32](#)
- ➔ [“PDL Print Configuration” on page 35](#)

Printer Settings

Select **Setup > System Administration > Printer Settings** from the home screen.

Menu	Settings and Explanations	
Paper Source Settings	Rear Paper Feed Priority	Feeds paper from the rear paper feed on a priority basis.
	A4/Letter Auto Switching	Feeds paper from the paper source set as A4 size when there is no paper source set as Letter, or feeds from the paper source set as Letter size when there is no paper source set as A4.
	Auto Select Settings	Specify which paper source to feed from when using features such as copying and faxing. When there are multiple paper sources available, paper is fed from the paper source with paper settings that match the copy or print job.
	Error Notice	Displays an error message when the paper size or type settings in Paper Setup and the print settings do not match.

Printer Basics

Menu	Settings and Explanations	
USB I/F Timeout Setting	Specify the length of time in seconds that must elapse before ending USB communication with a computer after the printer receives a print job from a PostScript printer driver or PCL printer driver. If the job ending is not clearly defined from a PostScript printer driver or PCL printer driver, it can cause endless USB communication. When this occurs, the printer ends communication after the specified time has elapsed. Enter 0 (zero) if you do not want to end communication.	
Printing Language	Select the printing language for the USB interface or the network interface.	
Auto Error Solver	<p>Select an action to perform when a 2-sided printing error or a memory full error occurs.</p> <p><input type="checkbox"/> 2-sided printing error</p> <p>Enabled: If a 2-sided job is sent when there is no paper available that supports 2-sided printing, the printer displays an error message, and then automatically prints on only one side of the paper.</p> <p>Disabled: The printer displays an error message and cancels printing.</p> <p><input type="checkbox"/> Memory full error</p> <p>Enabled: If the printer's memory becomes full while printing, the printer displays an error message, and then prints only the part of the data that the printer could process.</p> <p>Disabled: The printer displays an error message and cancels printing.</p>	
Memory Device Interface	Memory Device	Enables a memory device inserted in the printer. If this feature is disabled, the printer does not recognize the inserted memory device.
	File Sharing	Select whether to give write access to the memory device from a USB-connected computer or from a network-connected computer.
PC Connection via USB	Enables the printer which is connected to the computer over a USB connection. If this feature is disabled, the computer does not recognize printers with a USB connection.	

Fax Settings

Select **Setup > System Administration > Fax Settings** from the home screen.

Menu	Settings and Explanations	
User Default Settings	The settings made in this menu become your default settings for sending faxes. For details on the setting items, see the list of menus in Fax mode.	
Send Settings	Batch Send	See the pages that describe these features for more details.
	Save Failure Data	Saves documents that failed to be sent in the printer's memory. You can resend the documents from the Status Menu .
Receive Settings	Receive Mode	Select the receive mode.
	DRD	If you have subscribed to a distinctive ring service from your telephone company, select the ring pattern to be used for incoming faxes (or select On).
	Rings to Answer	Select the number of rings that must occur before the printer automatically receives a fax. Select "0" (zero) if you want to receive faxes with no ringing.
	Remote Receive	When you answer an incoming fax call on a phone connected to the printer, you can start receiving the fax by entering the code using the phone.

Printer Basics

Menu	Settings and Explanations	
Output Settings	Fax Output	You can set to save received documents in the inbox, on a memory device, or on a computer, or forward the documents.
	Auto Reduction	Reduces large received documents to fit on the paper in the paper source. Reducing may not always be possible depending on the received data. If this is turned off, large documents are printed at their original size on multiple sheets, or a blank second page may be ejected.
	Auto Rotation	Rotates automatically to print on A5 size paper when a landscape-oriented A5 size document is received and the paper source setting is set to A5. Prints on A4 size paper when this feature is disabled.
	Collation Stack	Prints received documents from the last page (print in descending order) so that the printed documents are stacked in the correct page order. When the printer is running low on memory, this feature may not be available.
	Print Suspend Time	Turn this on and enter the Time to Stop and Time to Restart to stop printing documents received during the specified time period and save them in the memory instead. Before using this feature, make sure there is enough free memory. You can check and print documents received during that time from the Status Menu . This feature can be used for noise prevention at night or to prevent confidential documents from being disclosed while you are away.
	Forwarding Report	Prints a report after forwarding a received document.
	Attach Image to Report	Prints a Transmission Report with an image of the first page of the sent document. On(Large Image): Prints the upper part of the page without reducing. On(Small Image): Prints the entire page reducing it to fit onto the report.
	Fax Log Auto Print	Prints the fax log automatically. On(Every 30): Prints a log every time 30 fax jobs are completed. On(Time): Prints the log at a specified time. However, if the number of fax jobs exceeds 30, the log is printed before the specified time.
Report Format	Select a format for fax reports other than Protocol Trace . Select Detail to print with error codes.	

Printer Basics

Menu	Settings and Explanations	
Basic Settings	Fax Speed	<p>Select the fax transmission speed.</p> <p>We recommend selecting Slow(9,600bps) when a communication error occurs frequently, when sending/receiving a fax to/from abroad, or when you are using an IP (VoIP) phone service.</p>
	ECM	Automatically corrects errors in the fax transmission (Error Correction Mode), mostly caused by telephone line noise. If this is disabled, you cannot send documents in color.
	Dial Tone Detection	<p>Detects a dial tone before starting to dial.</p> <p>If the printer is connected to a PBX (Private Branch Exchange) or digital phone line, the printer may fail to start dialing. In this situation, change the Line Type setting to PBX. If this does not work, disable this feature. However, disabling this feature may drop the first digit of a fax number and send the fax to the wrong number.</p>
	Dial Mode	Select the type of phone system to which you have connected the printer. When set to Pulse , you can temporarily switch the dialing mode from pulse to tone by pressing * ("T" is entered) while entering numbers on the fax top screen. Depending on the region, this setting may not be displayed.
	Line Type	Select the line type to which you have connected the printer. For more details, see the page that describes the settings for PBX.
	Header	<p>Enter your sender name and fax number. These appear as a header on outgoing faxes.</p> <p>You can enter up to 40 characters for your name, and up to 20 digits for your fax number.</p>
Security Settings	Direct Dialing Restrictions	Enable this to prevent fax numbers from being entered manually allowing the operator to select recipients only from the contacts list or sent history. Select Enter Twice to require the operator to enter the fax number again when a number is entered manually.
	Confirm Address List	Displays a recipient confirmation screen before starting the transmission.
	Inbox Password Settings	<p>Select to password protect the inbox to restrict users from viewing received faxes.</p> <p>Select Change to change the password, and select Reset to cancel password protection. When changing or resetting the password, you need the current password.</p>
	Backup Data Auto Clear	Fax documents deleted by using the control panel disappear from the LCD screen, but their backups are temporarily stored in the memory. The following features delete backups.
	Clear Backup Data	<p>Backup Data Auto Clear: Automatically deletes backups each time a sent or received document is deleted.</p> <p>Clear Backup Data: Deletes all backups. Run this before you give the printer to someone else or dispose of it.</p>
Check Fax Connection	Checks if the printer is connected to the phone line and ready for fax transmission, and prints the check result on A4 size plain paper.	
Fax Setting Wizard	<p>Select to make basic fax settings by following the on-screen instructions.</p> <p>For more details, see the page that describes basic fax settings.</p>	

Printer Basics

Related Information

- ➔ [“Fax Mode” on page 25](#)
- ➔ [“Saving Received Faxes” on page 102](#)
- ➔ [“Forwarding Received Faxes” on page 104](#)
- ➔ [“Sending Multiple Faxes to the Same Recipient at Once \(Batch Send\)” on page 99](#)
- ➔ [“Making Basic Fax Settings” on page 92](#)

PDL Print Configuration

Select **Setup > System Administration > Universal Print Settings > PDL Print Configuration** from the home screen.

Menu	Settings and Explanations	
Common Settings	Paper Size	Select the paper size.
	Paper Type	Select the paper type.
	Orientation	Select the printing direction.
	Quality	Select the print quality.
	Ink Save Mode	Conserves ink by reducing the print density.
	Print Order	Last Page on Top: Prints from the first page of a file. First Page on Top: Prints from the last page of a file.
	Number of Copies	Set the number of copies.
	Binding Margin	Select the binding position.
	Auto Paper Ejection	Ejects paper automatically when printing is stopped during a print job.
	2-Sided Printing	Performs 2-sided printing.

Printer Basics

Menu	Settings and Explanations	
PCL Menu	Font Source	Resident: Select to use a preinstalled font on the printer. Download: Select to use a font you have downloaded.
	Font Number	Select the default font number for the default font source. The available number varies depending on the settings you made.
	Pitch	Set the default font pitch if the font is scalable and of fixed-pitch. You can select from 0.44 to 99.99 cpi (characters per inch), in 0.01 increments. This item may not appear depending on the font source or font number settings.
	Height	Set the default font height if the font is scalable and proportional. You can select from 4.00 to 999.75 points, in 0.25 increments. This item may not appear depending on the font source or font number settings.
	Symbol Set	Select the default symbol set. If the font that you selected in the font source and the font number setting is not available in the new symbol set setting, the font source and the font number settings are automatically replaced with the default value, IBM-US .
	Form	Set the number of lines for the selected paper size and orientation. This also causes a line spacing (VMI) change, and the new VMI value is stored in the printer. This means that later changes in the page size or orientation settings cause changes in the Form value based on the stored VMI.
	CR Function	Select the line feed command when printing with a driver from a specific operating system.
	LF Function	
	Paper Source Assign	Set the assignment for the paper source select command. When 4 selected, the commands are set as compatible with the HP LaserJet 4. When 4K is selected, the commands are set as compatible with the HP LaserJet 4000, 5000, and 8000. When 5S is selected, the commands are set as compatible with the HP LaserJet 5S.
PS3 Menu	Error Sheet	Prints a sheet showing the error status when any PostScript errors occur while printing and any errors occur while printing a PDF file.
	Binary	Enable this feature when printing data that contains binary images. This settings is only available when the printer is connected to the network. The application may send the binary data even if the printer driver setting is set to ASCII, but you can print the data when this feature is enabled.
	PDF Page Size	Select the paper size when printing a PDF file. If Auto is selected, the paper size is determined based on the size of the first page that is printed.

Contacts Mode

Menu	Description
Menu	Registers contacts and a contact group, or prints the contacts list.
View	Select whether to display all contacts or the contacts for each feature only. LDAP allows you to search in the contacts registered in the LDAP server.

Printer Basics

Presets Mode

You can register frequently used copy, fax, and scan settings as presets. To register a preset, select **Presets** from the home screen, select **Add New**, and then select the feature for which you want to register a contact. Make the necessary settings, press **Save**, and then enter a name for the preset.

To load a registered preset, select the preset from the list.

Press **Preset** on the screen of each feature. You can register the current address (except for address that have been entered directly and the contacts in the LDAP address list) and settings.

Menu	Description
Menu	Displays the details of registered presets, and allows you to change their names, edit, and delete.

Status Menu

Press the **i** button on the control panel.

Menu	Description
Printer Information	Displays the status of the consumables and any errors that have occurred in the printer. Select the error from the list to display the error message.
Job Monitor	Displays a list of ongoing jobs and jobs waiting to be processed. You can also cancel jobs.
Job History	Displays the job history. If a job has failed, an error code is displayed in the history.
Job Storage	Select Inbox to display the received faxes stored in the printer's memory.
Confidential Job	Displays a list of jobs for which a password has been set. To print a job, select the job and enter the password.

Loading Paper

Paper Handling Precautions

- ❑ Read the instruction sheets supplied with the paper.
- ❑ Fan and align the edges of the paper before loading. Do not fan or curl photo paper. Doing so may damage the printable side.

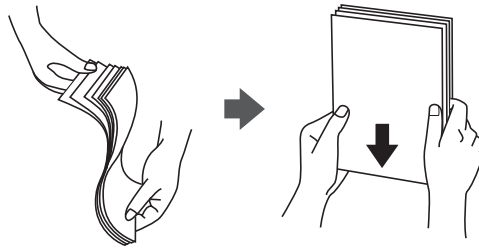

- ❑ If the paper is curled, flatten it or curl it slightly in the opposite direction before loading. Printing on curled paper may cause paper jams and smears on the printout.

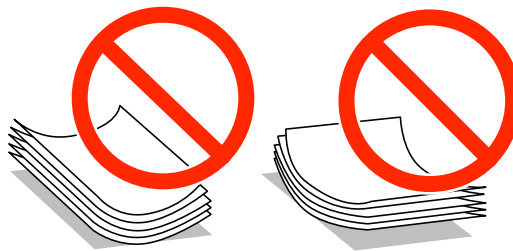

- ❑ Do not use paper that is wavy, torn, cut, folded, damp, too thick, too thin, or paper that has stickers stuck to it. Using these types of paper causes paper jams and smears on the printout.
- ❑ Fan and align the edges of the envelopes before loading. When the stacked envelopes are puffed up with air, press them down to flatten them before loading.

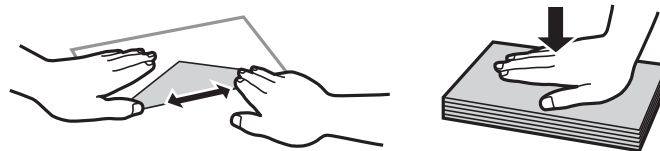

- ❑ Do not use envelopes that are curled or folded. Using these envelopes causes paper jams and smears on the printout.
- ❑ Do not use envelopes with adhesive surfaces on the flaps or window envelopes.
- ❑ Avoid using envelopes that are too thin, as they may curl during printing.

Related Information

- ➔ [“Printer Specifications” on page 166](#)

Available Paper and Capacities

Epson recommends using genuine Epson paper to ensure high-quality printouts.

Genuine Epson Paper

Note:

Genuine Epson paper is not available when printing with a PostScript printer driver and the Epson universal printer driver.

Media Name	Size	Loading Capacity (Sheets)			2-Sided Printing
		Paper Cassette 1	Paper Cassette 2	Rear Paper Feed	
Epson Bright White Ink Jet Paper	A4	200	200	50	Auto, Manual*
Epson Matte Paper-Heavyweight	A4	-	-	20	-
Epson Photo Quality Ink Jet Paper	A4	-	-	80	-

* Only use the rear paper feed to print 2-sided print jobs manually. You can load up to 20 sheets for paper with one side already printed.

Note:

The availability of paper varies by location. For the latest information on paper available in your area, contact Epson support.

Commercially Available Paper

Note:

Letterhead, recycled paper, color paper, and preprinted paper are not available when printing with a PostScript printer driver.

Loading Paper

Media Name	Size	Loading Capacity (Sheets or Envelopes)			2-Sided Printing
		Paper Cassette 1	Paper Cassette 2	Rear Paper Feed	
Plain paper Copy paper	Legal	Up to the line under the ▼ symbol inside the edge guide.		1	Manual* ¹
Letterhead Recycled paper	Letter, A4, B5	Up to the line under the ▼ symbol inside the edge guide.		80	Auto, Manual* ^{1*2}
Color paper Preprinted paper	A5	Up to the line under the ▼ symbol inside the edge guide.	-	80	Manual* ^{1*2}
	A6 Executive	-	-	80	Manual* ²
	User Defined (mm) 182×257 to 215.9×297	-	-	80	Auto, Manual* ²
	User Defined Except for the above	-	-	1	Manual
Thick paper	Legal	-	-	1	Manual
	Letter, A4, B5, A5, A6, Executive	-	-	10	Manual* ³
	User Defined (mm) 182×257 to 215.9×297	-	-	10	Manual* ³
	User Defined Except for the above	-	-	1	Manual
Envelope	Envelope #10, Envelope DL, Envelope C6	-	-	10	-
	Envelope C4	-	-	1	-

*1 Only use the rear paper feed to print 2-sided print jobs manually.

*2 You can load up to 30 sheets for paper with one side already printed.

*3 You can load up to 5 sheets for paper with one side already printed.

Related Information

➔ [“Part Names and Functions” on page 16](#)

➔ [“Technical Support Web Site” on page 186](#)

Loading Paper

List of Paper Types

To obtain optimum printing results, select the paper type that suits the paper.

Media Name	Media Type			
	Control panel	Printer Driver	PostScript Printer Driver	Epson Universal Printer Driver
Copy paper, Plain paper Epson Bright White Ink Jet Paper	plain papers	plain papers	Plain	Plain
Letterhead	Letterhead	Letterhead	Letterhead	Letterhead
Recycled paper	Recycled	Recycled	Recycled	Recycled
Color paper	Color	Color	Color	Color
Preprinted paper	Preprinted	Preprinted	Preprinted	Preprinted
Epson Matte Paper-Heavyweight Epson Photo Quality Ink Jet Paper	Matte	Epson Matte	-	-
Thick paper	Thick-Paper	Thick-Paper	Thick	Thick
Envelope	Envelope	Envelope	Envelope	Envelope

Loading Paper in the Paper Cassette

1. Check that the printer is not operating, and then pull out the paper cassette.

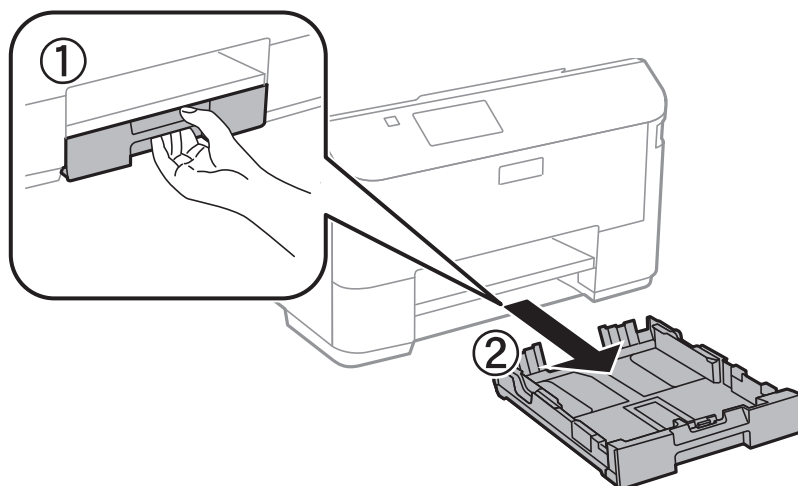
**Note:**

Remove the paper cassette cover from paper cassette 2.

Loading Paper

- Slide the edge guides to their maximum position.

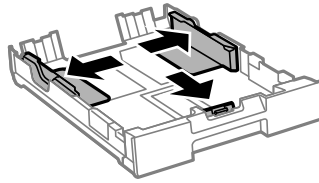

Note:

When using paper larger than A4 size, extend the paper cassette.

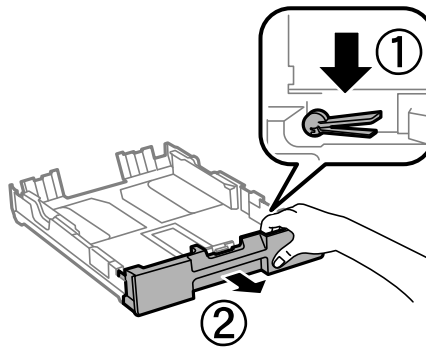

- Slide the front edge guide to the paper size you want to use.

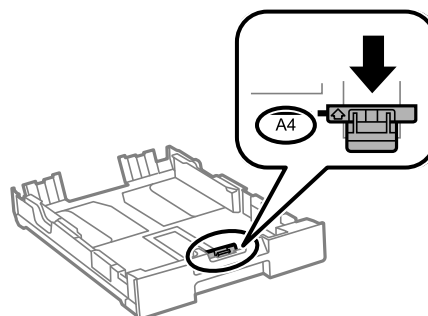

- With the printable side facing down, load paper against the front edge guide.

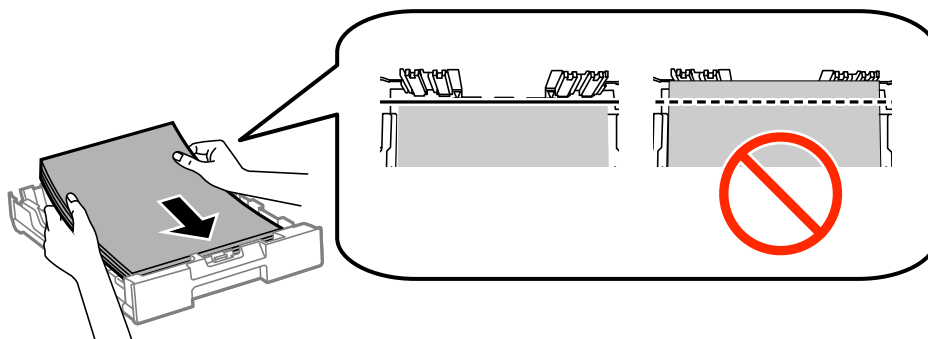

Loading Paper

! *Important:*

- Make sure the paper does not extend beyond the ▼ symbol at the end of the paper cassette.*
- Do not load more than the maximum number of sheets specified for the paper. For plain paper, do not load above the line just under the ▼ symbol inside the edge guide.*

5. Slide the side edge guides to the edges of the paper.

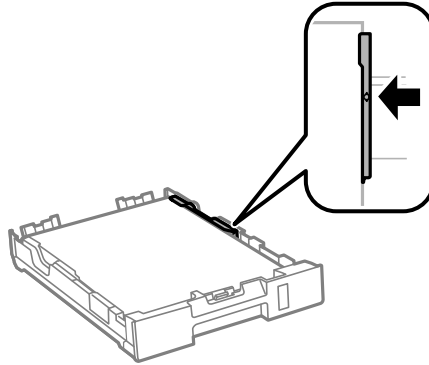

6. Insert the paper cassette all the way.

Note:

For paper cassette 2, reattach the paper cassette cover before inserting.

7. On the control panel, set the size and type of the paper you loaded in the paper cassette.

Note:

*You can also display the paper size and paper type settings screen by selecting **Setup > Paper Setup**.*

8. Slide out the output tray.

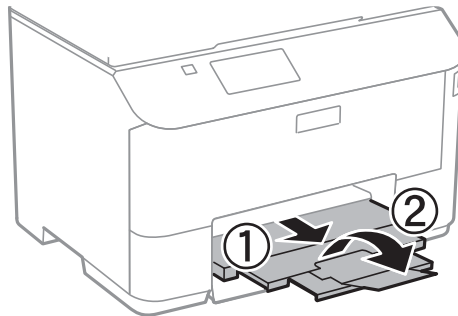

Related Information

- ➔ [“Paper Handling Precautions” on page 38](#)
- ➔ [“Available Paper and Capacities” on page 39](#)

Loading Paper in the Rear Paper Feed

1. Open the feeder guard and pull out the paper support.

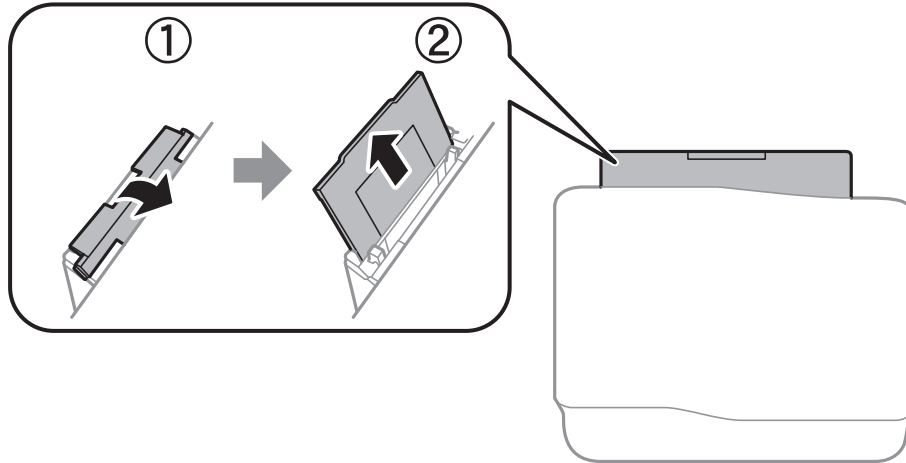

2. Slide the edge guides.

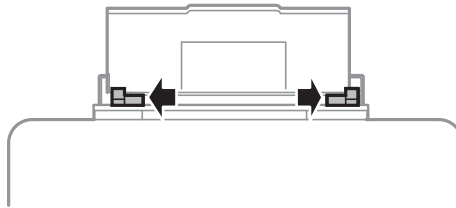

3. Load paper at the center of the rear paper feed with the printable side facing up.

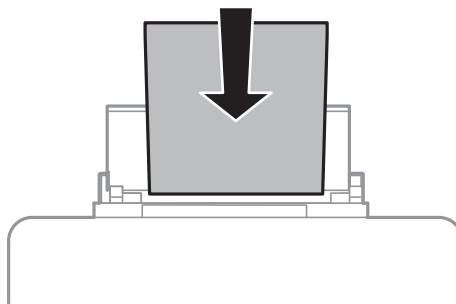

! Important:

- ❑ Do not load more than the maximum number of sheets specified for the paper. For plain paper, do not load above the line just under the ▼ symbol inside the edge guide.
- ❑ Load paper short edge first. However, when you have set the long edge as the width of the user defined size, load paper long edge first.

Loading Paper

- ❑ Envelope

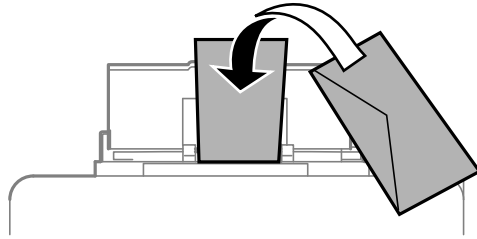

- ❑ Pre-punched paper

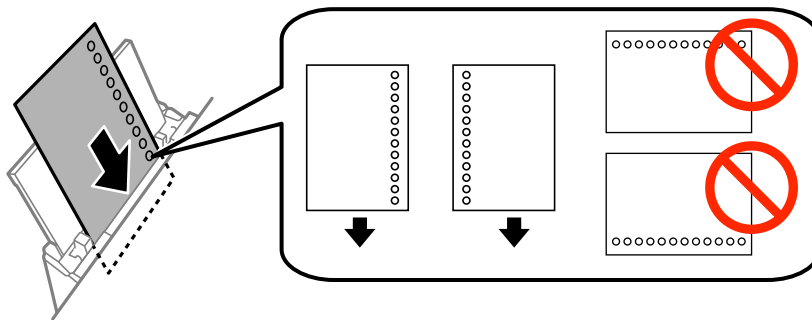

Note:

You can use pre-punched paper under the following conditions. Automatic 2-sided printing is not available for pre-punched paper.

- ❑ Loading capacity: One sheet
- ❑ Available size: A4, B5, A5, A6, Letter, Legal
- ❑ Binding holes: Do not load paper with the binding holes at the top or the bottom. Adjust the print position of your file to avoid printing over the holes.

4. Slide the edge guides to the edges of the paper.

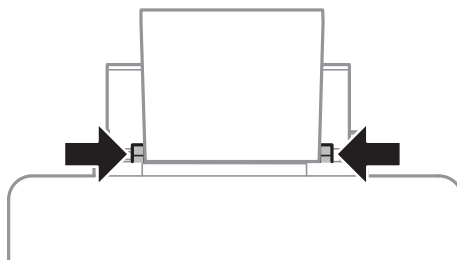

5. On the control panel, select **Setup > Paper Setup > Rear Paper Feed**, and then set the size and type of the paper you loaded in the rear paper feed.

Loading Paper

6. Slide out the output tray.

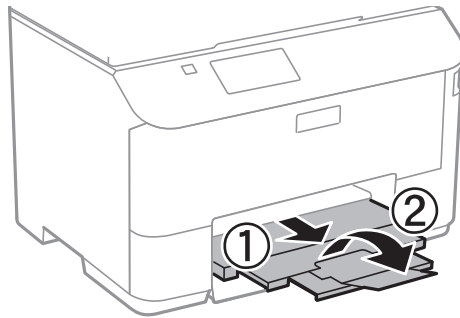

Note:

Return the remaining paper to its package. If you leave it in the printer, the paper may curl or the print quality may decline.

Related Information

- ➔ [“Paper Handling Precautions” on page 38](#)
- ➔ [“Available Paper and Capacities” on page 39](#)

Placing Originals

Place originals on the scanner glass or the ADF. Use the scanner glass for originals that the ADF does not support. You can scan multiple originals and both sides of the originals at the same time with the ADF.

Available Originals for the ADF

Available Paper Sizes	A4, A5*, B5, Legal*, Letter
Paper Type	Plain paper
Paper Thickness (Weight of Paper)	64 to 95 g/m ²
Loading Capacity	Except for Legal: 30 sheets or 3 mm Legal: 10 sheets

* Only single-sided scanning is supported.

To prevent paper jams, avoid placing the following originals in the ADF. For these types, use the scanner glass.

- Originals that are torn, folded, wrinkled, deteriorated, or curled
- Originals with binder holes
- Originals held together with tape, staples, paper clips etc.
- Originals that have stickers or labels stuck to them
- Originals that are cut irregularly or not right angled
- Originals that are bound
- OHPs, thermal transfer paper, or carbon backs

Placing Originals on the ADF

1. Align the edges of the originals.

Placing Originals

- Slide the ADF edge guide.

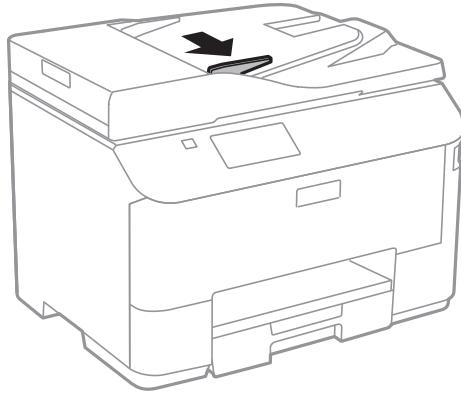

- Place the originals face up in the ADF.



! *Important:*

- Do not load originals above the line just under the ▼ symbol inside the ADF edge guide.
- Do not add originals while scanning.

Placing Originals

- Slide the ADF edge guide to the edge of the originals.

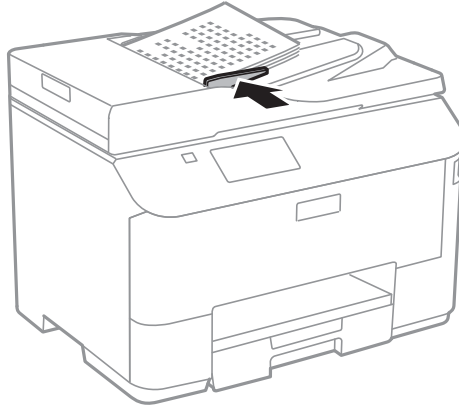

Related Information

➔ [“Available Originals for the ADF” on page 47](#)

Placing Originals on the Scanner Glass



Caution:

Be careful not to trap your fingers when closing the document cover. Otherwise you may be injured.



Important:

When placing bulky originals such as books, prevent exterior light from shining directly onto the scanner glass.

Placing Originals

1. Open the document cover.

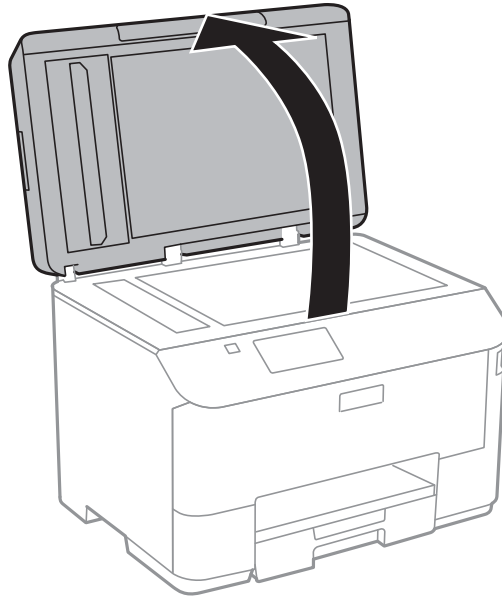

2. Remove any dust or stains on the scanner glass.
3. Place the original face-down and slide it to the corner mark.

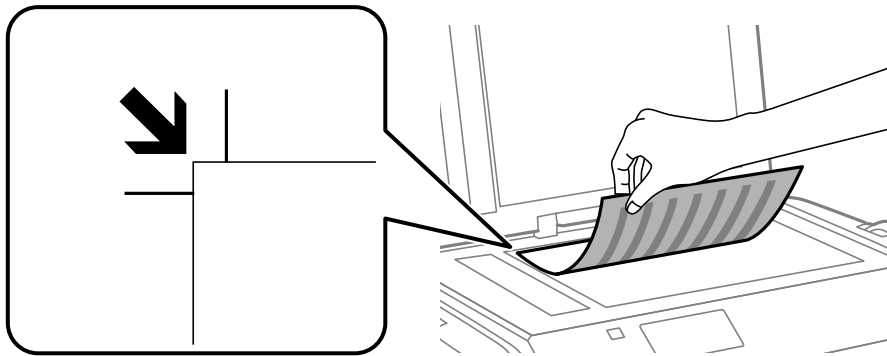

Note:

- ❑ A range of 1.5 mm from the edges of the scanner glass is not scanned.
- ❑ When originals are placed in the ADF and on the scanner glass, priority is given to the originals in the ADF.

4. Close the cover gently.

Note:

Remove the originals after scanning or copying. If you leave the originals on the scanner glass for a long time, they may stick to the surface of the glass.

Managing Contacts

Registering a contacts list allows you to easily enter destinations. You can register up to 200 entries, and you can use the contacts list when you enter a fax number, enter a destination for attaching a scanned image to an email, and saving a scanned image to a network folder.

You can also register contacts in the LDAP server. See the *Administrator's Guide* to register contacts in the LDAP server.

Registering Contacts

Note:

Before registering contacts, make sure you have also configured the email server settings to use the email address.

1. Select **Contacts** from the home screen, the **Scan** mode, or the **Fax** mode.
2. Press **Menu**, and then select **Add Entry**.
3. Select in which mode you want to use the contact.

Note:

This screen is displayed when you open the contacts list from the home screen.

4. Select the entry number that you want to register.
5. Make the necessary settings for each mode.

Note:

When entering a fax number, enter an external access code at the beginning of the fax number if your phone system is PBX and you need the access code to get an outside line. If the access code has been set in the **Line Type** setting, enter a hash (#) instead of the actual access code. To add a pause (pause for three seconds) during dialing, enter a hyphen by pressing .

6. Press **Save**.

Note:

To edit or delete an entry, select the target entry and press **Edit** or **Delete**.

You can register an address that is registered in the LDAP server in the local contacts list of the printer. Display an entry, and then press **Save**.

Registering Grouped Contacts

Adding contacts to a group allows you to send a fax or send a scanned image by an email to multiple destinations at the same time.

1. Select **Contacts** from the home screen, the **Scan** mode, or the **Fax** mode.
2. Press **Menu**, and then select **Add Group**.

Managing Contacts

3. Select in which mode you want to use the grouped contact.

Note:

This screen is displayed when you open the contacts list from the home screen.

4. Select the entry number that you want to register.
5. Enter **Name** and **Index Word**, and then press **Proceed**.
6. Press the check box of the contacts that you want to register in the group.

Note:

You can register up to 199 contacts.

To deselect, press the check box of the contact again.

7. Press **Save**.

Note:

*To edit or delete a grouped contact, select the target grouped contact and press **Edit** or **Delete**.*

Registration and Backup of Contacts Using a Computer

You can register and backup contacts on the printer using EpsonNet Config. See the EpsonNet Config help for details.

Contacts data may be lost due to a printer malfunction. We recommend that you make a backup of the data whenever you update the data. Epson shall not be responsible for the loss of any data, for backing up or recovering data and/or settings even during a warranty period.

Related Information

- ➔ [“EpsonNet Config” on page 129](#)

Printing

Printing from the Control Panel

You can print data stored on a memory device, such as a USB flash drive, directly.

1. Load paper in the printer.
2. Insert a memory device into the printer's external interface USB port.
3. Enter **Memory Device** from the home screen.
4. Select a file format.

Note:

*If you have more than 999 images on your memory device, images are automatically divided into groups and the group selection screen is displayed. Select the group that contains the image you want to print. Images are sorted by the date they were taken. To select another group, select **Options** > **Select Group**.*

5. Select the file you want to print.
6. Enter the number of printouts using the numeric keypad.
7. Press **Settings**, and then make print settings.

Note:

*When you select JPEG as the file format, you can adjust the image. Press **Adjustments**. You can also add more images. Press the  button, or swipe the screen horizontally to select the image.*

8. Press the  button.

Related Information

- ➔ [“Loading Paper in the Paper Cassette” on page 41](#)
- ➔ [“Loading Paper in the Rear Paper Feed” on page 44](#)
- ➔ [“Part Names and Functions” on page 16](#)
- ➔ [“Memory Device Mode” on page 26](#)

Printing from a Computer

If you cannot change some of the printer driver settings, they may have been restricted by the administrator. Contact your printer administrator for assistance.

Authenticating Users in the Printer Driver when User Feature Restriction Is Enabled (for Windows Only)

When the user feature restriction is enabled, a user ID and password are required to print. Register the user ID and password in the printer driver. If you do not know the password, contact your printer administrator.

Printing

1. Access the printer driver window.
2. Click **Printer and Option Information** on the **Maintenance** tab.
3. Select **Save Access Control settings**, click **Settings**, and then enter the user name and the password.

Related Information

➔ [“Windows Printer Driver” on page 125](#)

Printing Basics - Windows

Note:

- ❑ See the online help for explanations of the setting items. Right-click an item, and then click **Help**.
- ❑ Operations may differ depending on the application. See the application's help for details.

1. Load paper in the printer.
2. Open the file you want to print.
3. Select **Print** or **Print Setup** from the **File** menu.
4. Select your printer.
5. Select **Preferences** or **Properties** to access the printer driver window.

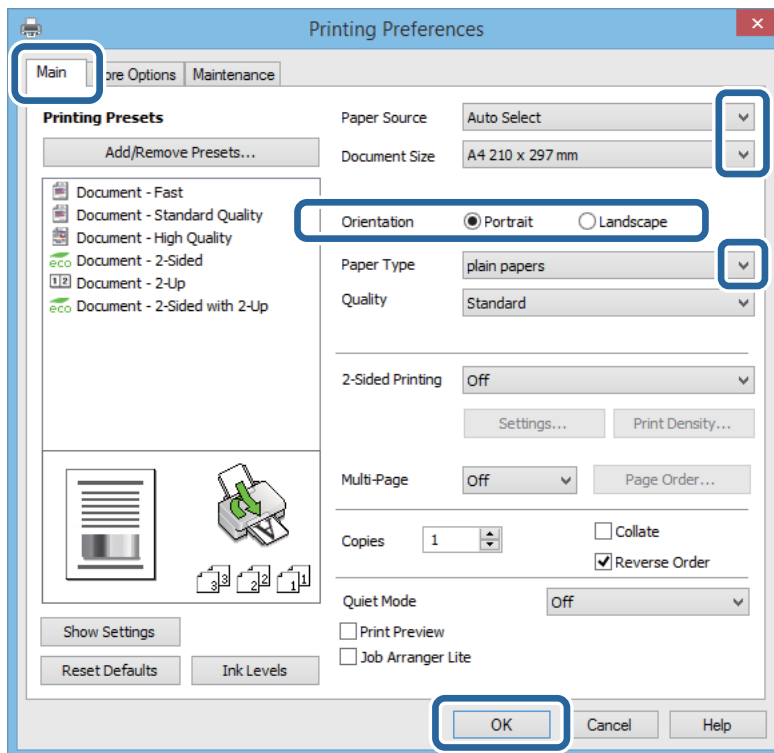

6. Make the following settings.
 - ❑ Paper Source: Select the paper source in which you loaded the paper.
 - ❑ Document Size: Select the paper size you loaded in the printer.

Printing

- Orientation: Select the orientation you set in the application.
- Paper Type: Select the type of paper you loaded.

Note:

When printing on envelopes, select *Landscape* as the **Orientation** setting.

7. Click **OK** to close the printer driver window.
8. Click **Print**.

Related Information

- ➔ [“Available Paper and Capacities” on page 39](#)
- ➔ [“Loading Paper in the Paper Cassette” on page 41](#)
- ➔ [“Loading Paper in the Rear Paper Feed” on page 44](#)
- ➔ [“List of Paper Types” on page 41](#)
- ➔ [“Authenticating Users in the Printer Driver when User Feature Restriction Is Enabled \(for Windows Only\)” on page 53](#)

Printing Basics - Mac OS X

Note:

Operations differ depending on the application. See the application's help for details.

1. Load paper in the printer.
2. Open the file you want to print.
3. Select **Print** from the **File** menu or another command to access the print dialog.

If necessary, click **Show Details** or ▼ to expand the print window.

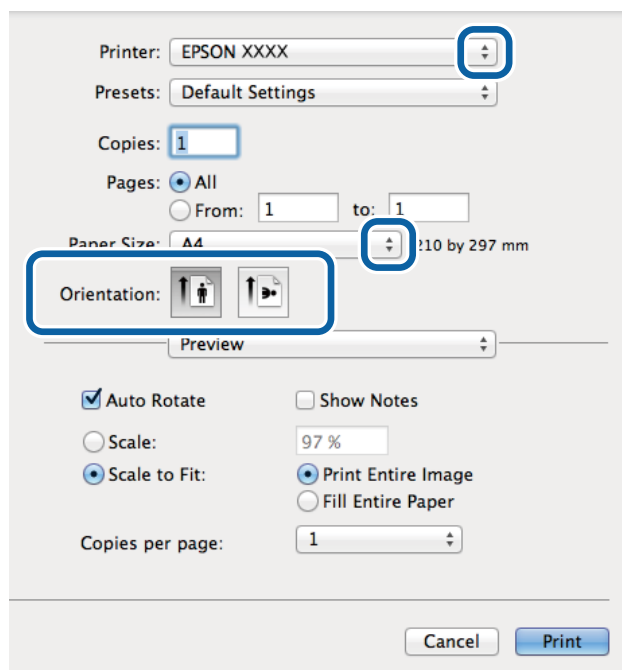

Printing

4. Make the following settings.

- Printer: Select your printer.
- Presets: Select when you want to use the registered settings.
- Paper Size: Select the paper size you loaded in the printer.
- Orientation: Select the orientation you set in the application.

Note:

When printing on envelopes, select landscape orientation.

5. Select **Print Settings** from the pop-up menu.

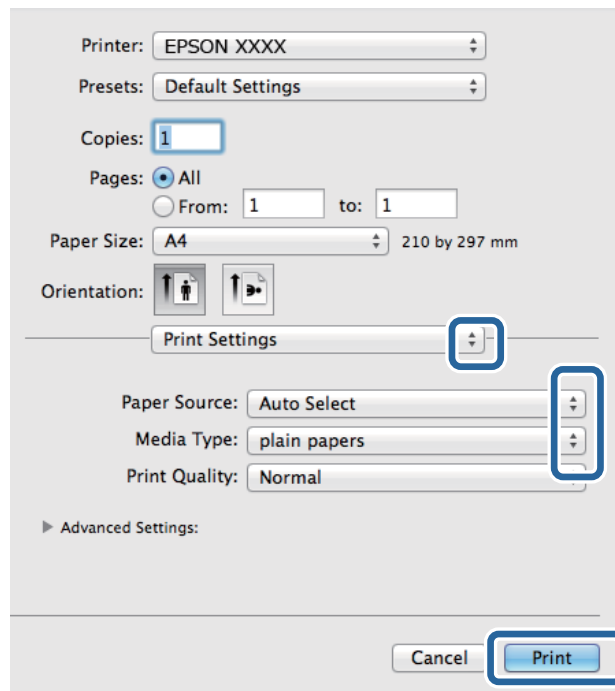

Note:

*On Mac OS X v10.8.x or later, if the **Print Settings** menu is not displayed, the Epson printer driver has not been installed correctly.*

Select **System Preferences** from the  menu > **Printers & Scanners** (or **Print & Scan**, **Print & Fax**), remove the printer, and then add the printer again. See the following to add a printer.

<http://epson.sn>

6. Make the following settings.

- Paper Source: Select the paper source in which you loaded the paper.
- Media Type: Select the type of paper you loaded.

7. Click **Print**.

Related Information

- ➔ “Available Paper and Capacities” on page 39
- ➔ “Loading Paper in the Paper Cassette” on page 41
- ➔ “Loading Paper in the Rear Paper Feed” on page 44

Printing

➔ [“List of Paper Types” on page 41](#)

Printing on 2-Sides

You can use either of the following methods to print on both sides of the paper.

- Automatic 2-sided printing
- Manual 2-sided printing (for Windows only)

When the printer has finished printing the first side, flip the paper over to print on the other side.

You can also print a booklet that can be created by folding the printout. (For Windows only)

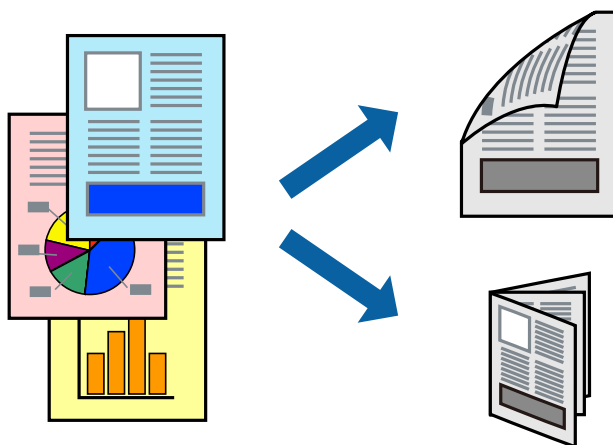

Note:

- If you do not use paper that is suitable for 2-sided printing, the print quality may decline and paper jams may occur.
- Depending on the paper and the data, ink may bleed through to the other side of the paper.

Related Information

➔ [“Available Paper and Capacities” on page 39](#)

Printing on 2-Sides - Windows

Note:

- Manual 2-sided printing is available when **EPSON Status Monitor 3** is enabled. If **EPSON Status Monitor 3** is disabled, access the printer driver, click **Extended Settings** on the **Maintenance** tab, and then select **Enable EPSON Status Monitor 3**.
- Manual 2-sided printing may not be available when the printer is accessed over a network or is used as a shared printer.

1. Load paper in the printer.
2. Open the file you want to print.
3. Access the printer driver window.
4. Select **Auto (Long-edge binding)**, **Auto (Short-edge binding)**, **Manual (Long-edge binding)**, or **Manual (Short-edge binding)** from **2-Sided Printing** on the **Main** tab.

Printing

- Click **Settings**, make the appropriate settings, and then click **OK**.

Note:

To print a folded booklet, select **Booklet**.

- Click **Print Density**, select the document type from **Select Document Type**, and then click **OK**.

The printer driver automatically sets the **Adjustments** options for that document type.

Note:

Printing may be slow depending on the combination of options selected for **Select Document Type** in the **Print Density Adjustment** window and for **Quality** on the **Main** tab.

For manual 2-sided printing, the **Print Density Adjustment** setting is not available.

- Set the other items on the **Main** and **More Options** tabs as necessary, and then click **OK**.

- Click **Print**.

For manual 2-sided printing, when the first side has finished printing, a pop-up window is displayed on the computer. Follow the on-screen instructions.

Related Information

- ➔ [“Loading Paper in the Paper Cassette” on page 41](#)
- ➔ [“Loading Paper in the Rear Paper Feed” on page 44](#)
- ➔ [“Printing Basics - Windows” on page 54](#)

Printing on 2-Sides - Mac OS X

- Load paper in the printer.
- Open the file you want to print.
- Access the print dialog.
- Select **Two-sided Printing Settings** from the pop-up menu.
- Select the bindings and **Document Type**.

Note:

Printing may be slow depending on the **Document Type** setting.

If you are printing high-density data such as photos or graphs, select **Text & Graphics** or **Text & Photos** as the **Document Type** setting. If scuffing occurs or the image bleeds through to the reverse side, adjust the print density and ink drying time by clicking the arrow mark next to **Adjustments**.

- Set the other items as necessary.

- Click **Print**.

Related Information

- ➔ [“Loading Paper in the Paper Cassette” on page 41](#)
- ➔ [“Loading Paper in the Rear Paper Feed” on page 44](#)
- ➔ [“Printing Basics - Mac OS X” on page 55](#)

Printing

Printing Several Pages on One Sheet

You can print two or four pages of data on a single sheet of paper.

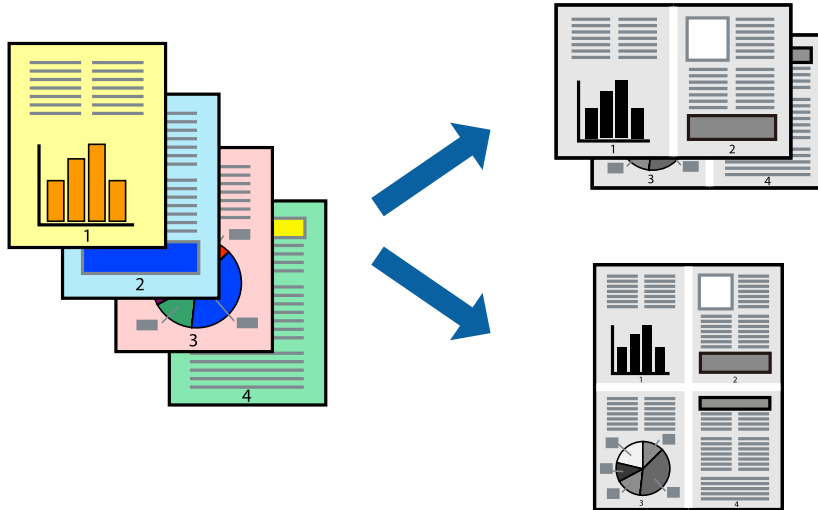

Printing Several Pages on One Sheet - Windows

1. Load paper in the printer.
2. Open the file you want to print.
3. Access the printer driver window.
4. Select **2-Up** or **4-Up** as the **Multi-Page** setting on the **Main** tab.
5. Click **Page Order**, make the appropriate settings, and then click **OK** to close the window.
6. Set the other items on the **Main** and **More Options** tabs as necessary, and then click **OK**.
7. Click **Print**.

Related Information

- ➔ [“Loading Paper in the Paper Cassette” on page 41](#)
- ➔ [“Loading Paper in the Rear Paper Feed” on page 44](#)
- ➔ [“Printing Basics - Windows” on page 54](#)

Printing Several Pages on One Sheet - Mac OS X

1. Load paper in the printer.
2. Open the file you want to print.
3. Access the print dialog.
4. Select **Layout** from the pop-up menu.

Printing

5. Set the number of pages in **Pages per Sheet**, the **Layout Direction** (page order), and **Border**.
6. Set the other items as necessary.
7. Click **Print**.

Related Information

- ➔ [“Loading Paper in the Paper Cassette” on page 41](#)
- ➔ [“Loading Paper in the Rear Paper Feed” on page 44](#)
- ➔ [“Printing Basics - Mac OS X” on page 55](#)

Printing to Fit the Paper Size

You can print to fit the paper size you loaded in the printer.



Printing to Fit the Paper Size - Windows

1. Load paper in the printer.
 2. Open the file you want to print.
 3. Access the printer driver window.
 4. Make the following settings on the **More Options** tab.
 - Document Size: Select the paper size you set in the application.
 - Output Paper: Select the paper size you loaded in the printer.
Fit to Page is selected automatically.
- Note:**
*If you want to print a reduced image at the center of the page, select **Center**.*
5. Set the other items on the **Main** and **More Options** tabs as necessary, and then click **OK**.
 6. Click **Print**.

Related Information

- ➔ [“Loading Paper in the Paper Cassette” on page 41](#)

Printing

- ➔ “Loading Paper in the Rear Paper Feed” on page 44
- ➔ “Printing Basics - Windows” on page 54

Printing to Fit the Paper Size - Mac OS X

1. Load paper in the printer.
2. Open the file you want to print.
3. Access the print dialog.
4. Select the size of the paper you set in the application as the **Paper Size** setting.
5. Select **Paper Handling** from the pop-up menu.
6. Select **Scale to fit paper size**.
7. Select the paper size you loaded in the printer as the **Destination Paper Size** setting.
8. Set the other items as necessary.
9. Click **Print**.

Related Information

- ➔ “Loading Paper in the Paper Cassette” on page 41
- ➔ “Loading Paper in the Rear Paper Feed” on page 44
- ➔ “Printing Basics - Mac OS X” on page 55

Printing Multiple Files Together (for Windows Only)

Job Arranger Lite allows you to combine several files created by different applications and print them as a single print job. You can specify the print settings for combined files, such as layout, print order, and orientation.

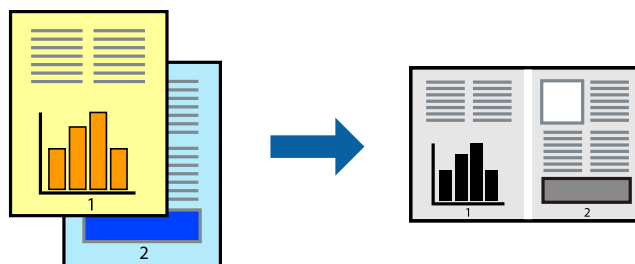

Note:

To open a **Print Project** saved in **Job Arranger Lite**, click **Job Arranger Lite** on the printer driver's **Maintenance** tab. Next, select **Open** from the **File** menu to select the file. The extension of the saved files is ".ecl".

1. Load paper in the printer.
2. Open the file you want to print.
3. Access the printer driver window.

Printing

4. Select **Job Arranger Lite** on the **Main** tab.
5. Click **OK** to close the printer driver window.
6. Click **Print**.

The **Job Arranger Lite** window is displayed and the print job is added to the **Print Project**.

7. With the **Job Arranger Lite** window opened, open the file that you want to combine with the current file, and then repeat steps 3 to 6.

Note:

*If you close the **Job Arranger Lite** window, the unsaved **Print Project** is deleted. To print later, select **Save** from the **File** menu.*

8. Select the **Layout** and **Edit** menus in **Job Arranger Lite** to edit the **Print Project** as necessary.
9. Select **Print** from the **File** menu.

Related Information

- ➔ [“Loading Paper in the Paper Cassette” on page 41](#)
- ➔ [“Loading Paper in the Rear Paper Feed” on page 44](#)
- ➔ [“Printing Basics - Windows” on page 54](#)

Enlarged Printing and Making Posters (for Windows Only)

You can print one image on multiple sheets of paper to create a larger poster. You can print alignment marks that help you stick the sheets together.

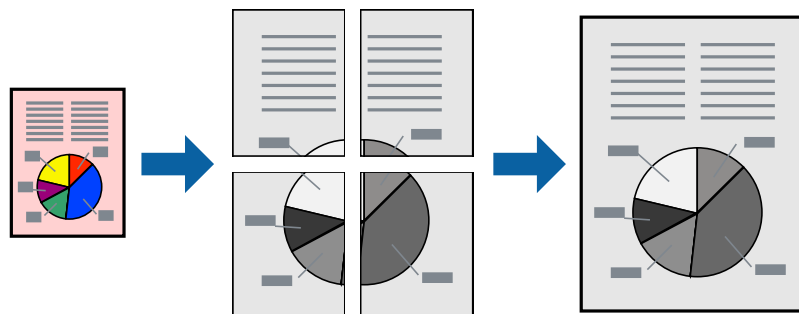

1. Load paper in the printer.
2. Open the file you want to print.
3. Access the printer driver window.
4. Select **2x1 Poster**, **2x2 Poster**, **3x3 Poster**, or **4x4 Poster** from **Multi-Page** on the **Main** tab.
5. Click **Settings**, make the appropriate settings, and then click **OK**.
6. Set the other items on the **Main** and **More Options** tabs as necessary, and then click **OK**.
7. Click **Print**.

Printing

Related Information

- ➔ [“Loading Paper in the Paper Cassette” on page 41](#)
- ➔ [“Loading Paper in the Rear Paper Feed” on page 44](#)
- ➔ [“Printing Basics - Windows” on page 54](#)

Making Posters Using Overlapping Alignment Marks

Here is an example of how to make a poster when **2x2 Poster** is selected, and **Overlapping Alignment Marks** is selected in **Print Cutting Guides**.

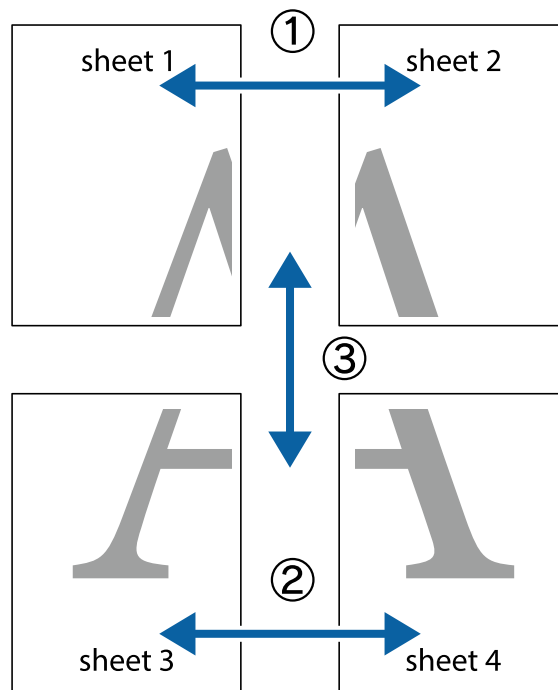

Printing

1. Prepare Sheet 1 and Sheet 2. Cut off the margins of Sheet 1 along the vertical blue line through the center of the top and bottom cross marks.

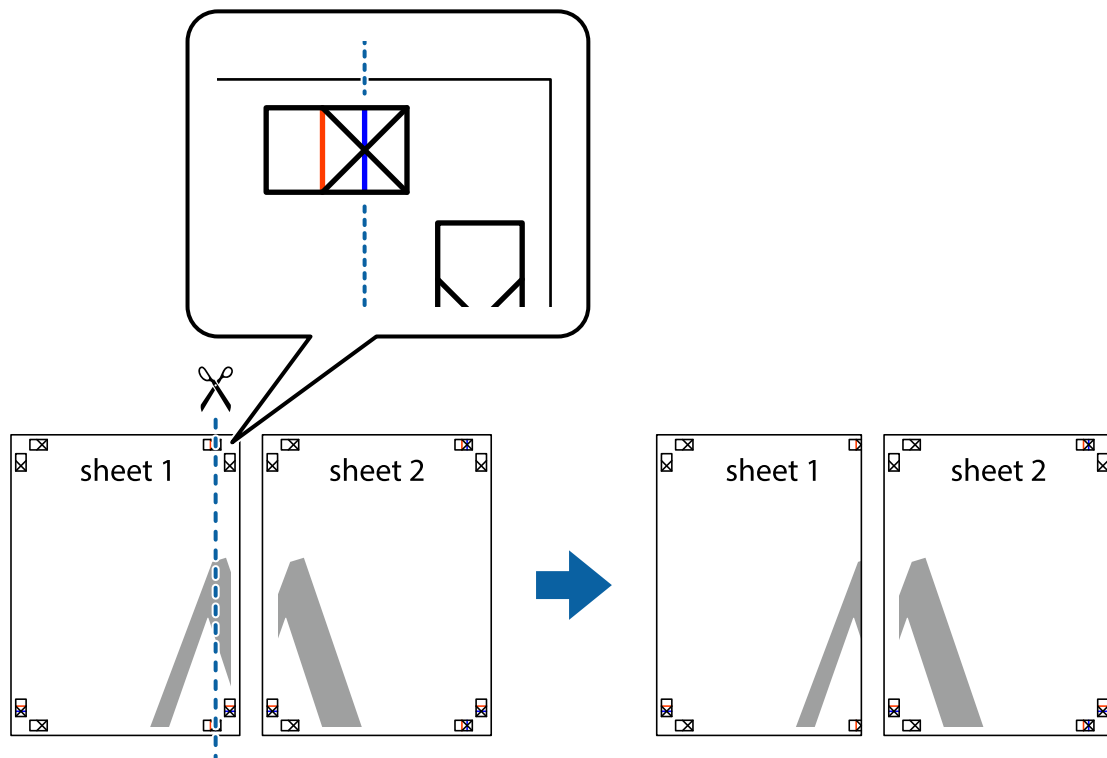

2. Place the edge of Sheet 1 on top of Sheet 2 and align the cross marks, then temporarily tape the two sheets together from the back.

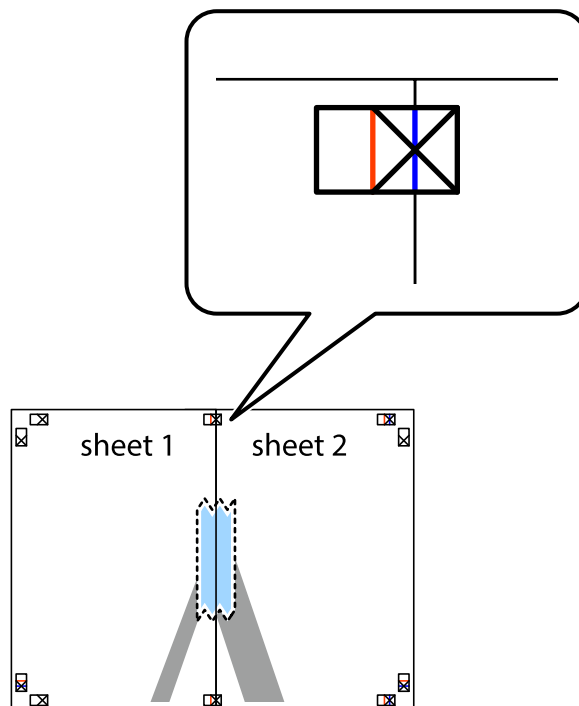

Printing

- Cut the taped sheets in two along the vertical red line through the alignment markers (this time, the line to the left of the cross marks).

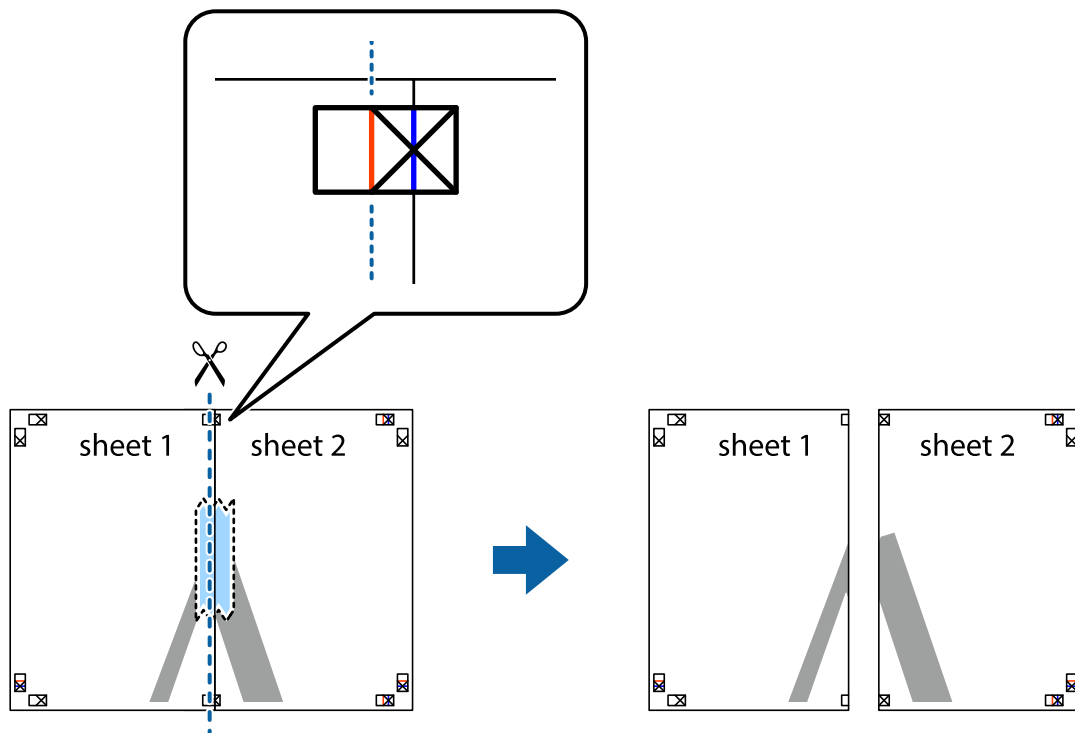

- Tape the sheets together from the back.

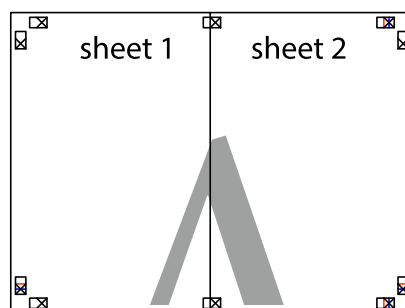

- Repeat steps 1 to 4 to tape Sheet 3 and Sheet 4 together.

Printing

6. Cut off the margins of Sheet 1 and Sheet 2 along the horizontal blue line through the center of the left and right side cross marks.

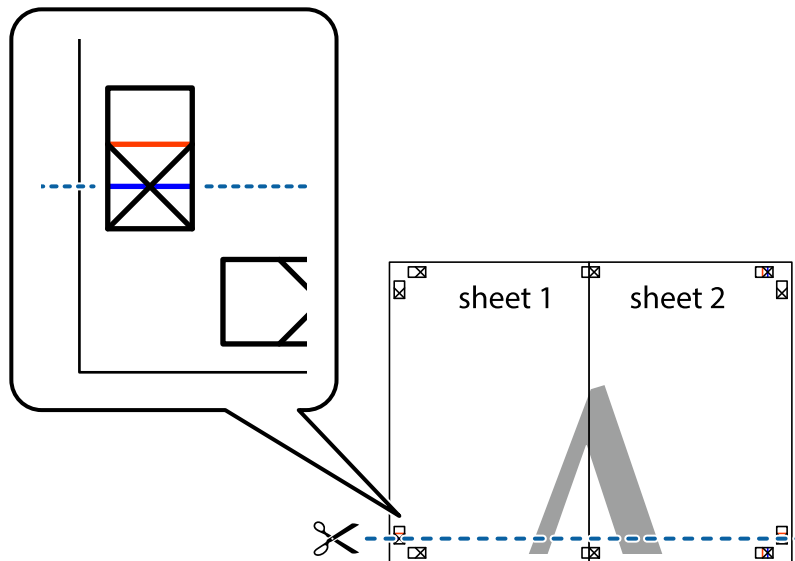

7. Place the edge of Sheet 1 and Sheet 2 on top of Sheet 3 and Sheet 4 and align the cross marks, and then temporarily tape them together from the back.

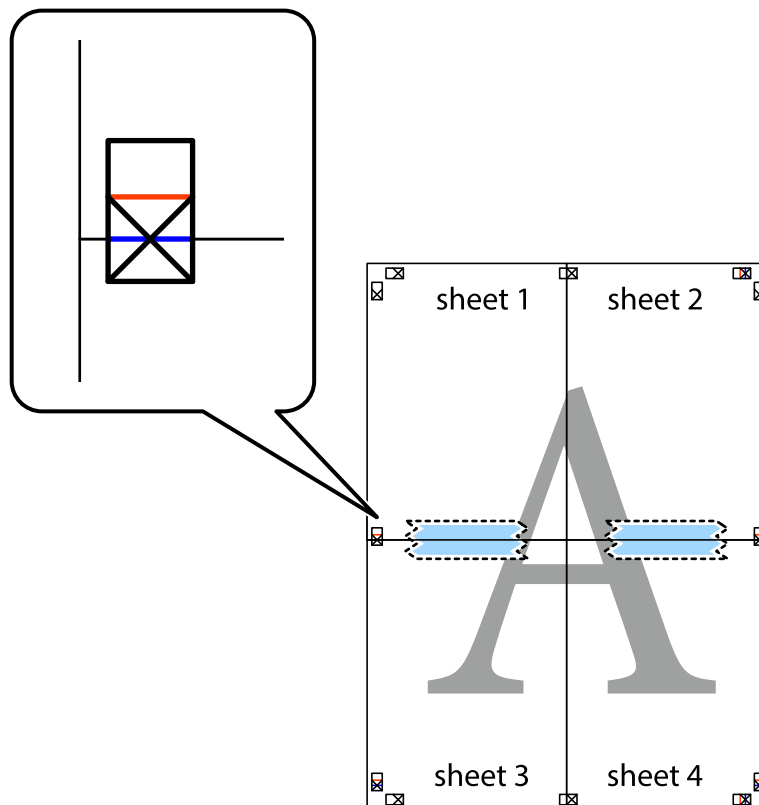

Printing

- Cut the taped sheets in two along the horizontal red line through the alignment markers (this time, the line above the cross marks).

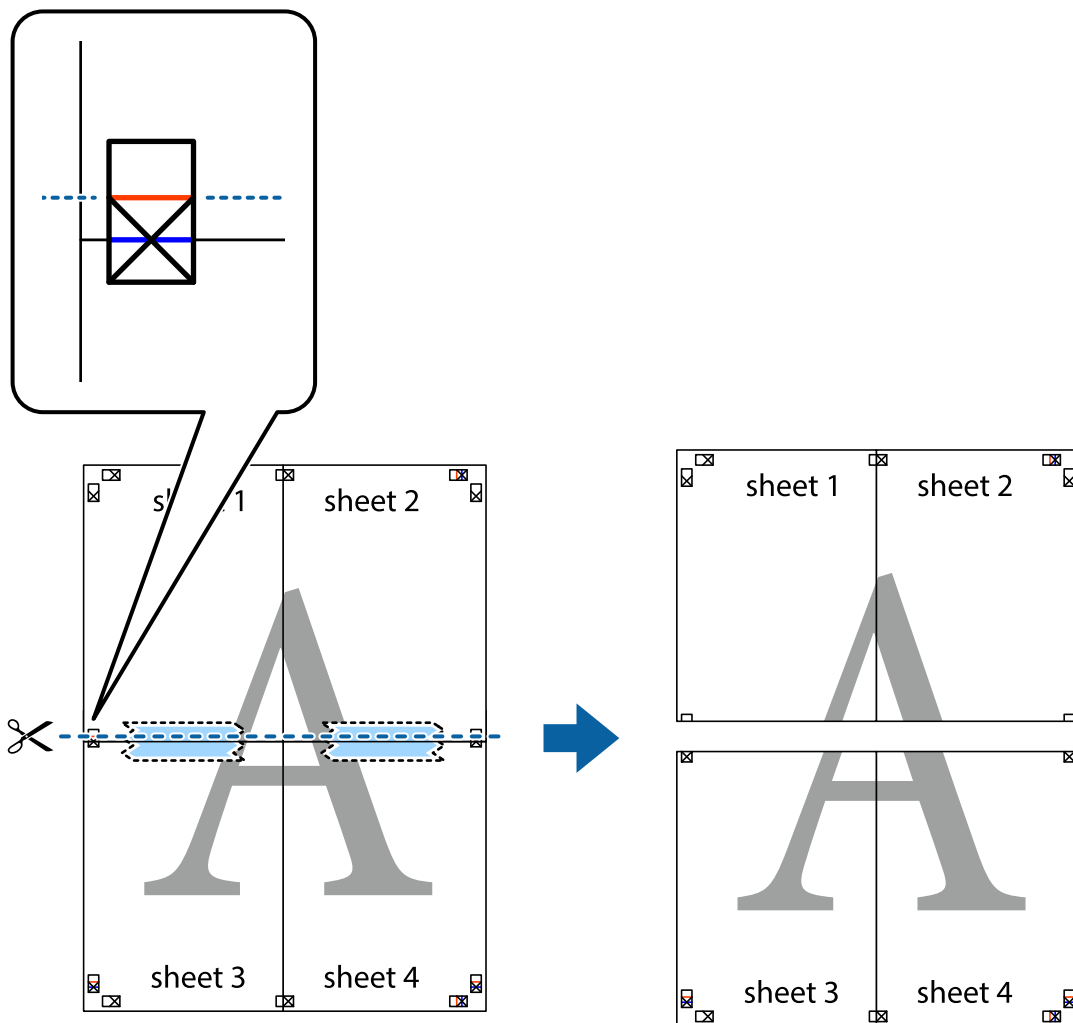

- Tape the sheets together from the back.

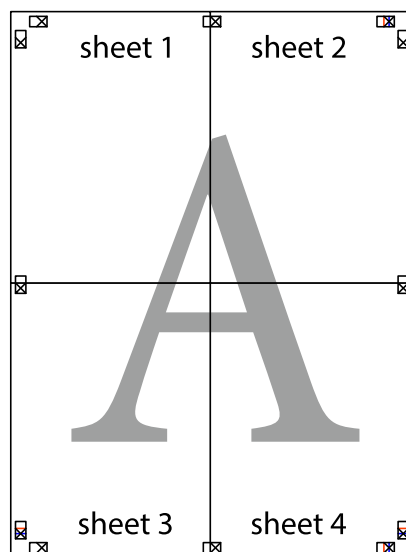

Printing

10. Cut off the remaining margins along the outer guide.

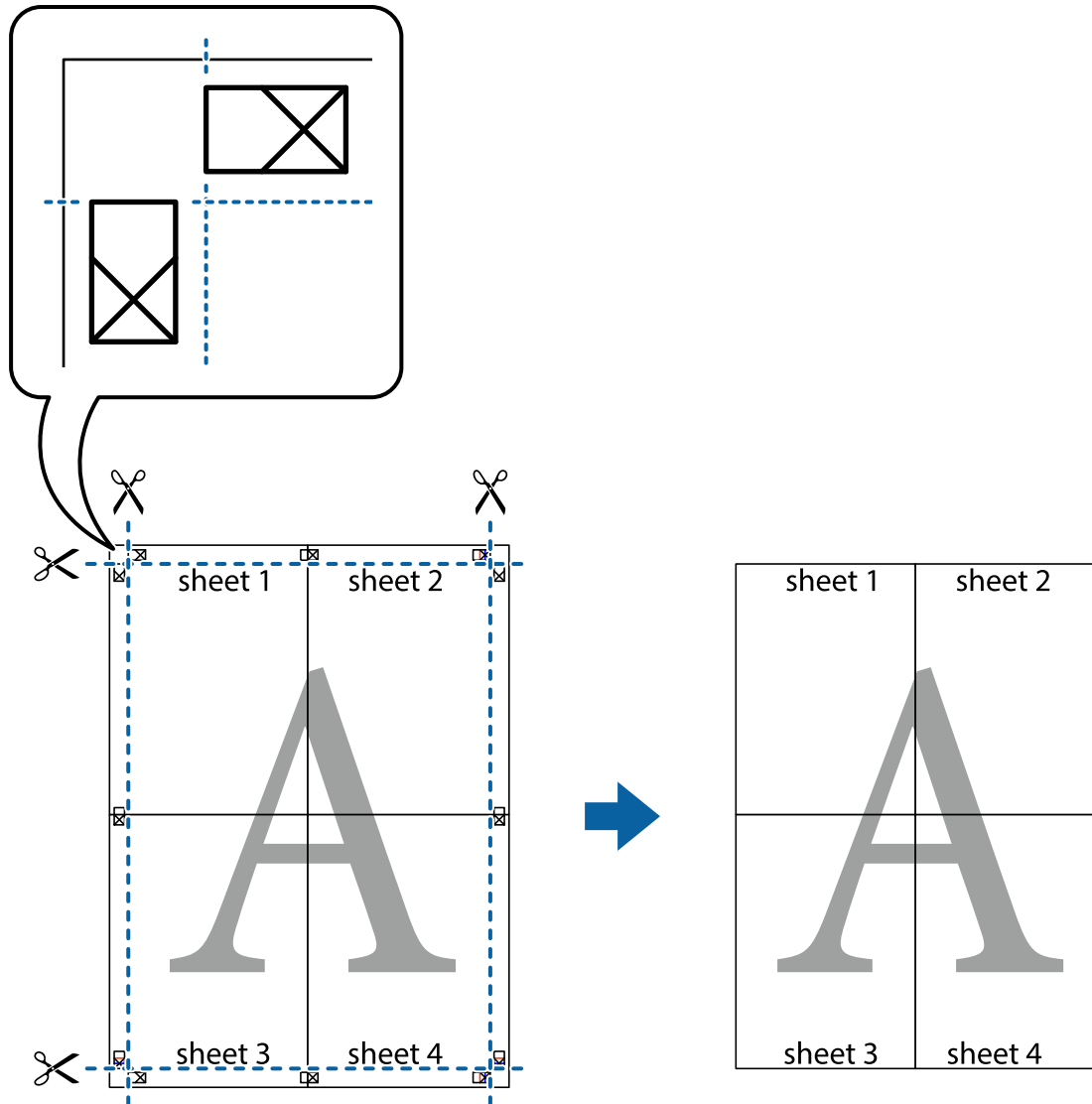

Printing Using Advanced Features

This section introduces a variety of additional layout and printing features available on the printer driver.

Related Information

- ➔ [“Windows Printer Driver” on page 125](#)
- ➔ [“Mac OS X Printer Driver” on page 126](#)

Adding a Printing Preset

If you create your own preset of frequently used print settings on the printer driver, you can print easily by selecting the preset from the list.

Printing

Windows

To add your own preset, set items such as the **Document Size** and **Paper Type** on the **Main** or **More Options** tab, and then click **Add/Remove Presets** in **Printing Presets**.

Mac OS X

Access the print dialog. To add your own preset, set items such as the **Paper Size** and **Media Type**, and then save the current settings as the preset in the **Presets** setting.

Printing a Reduced or Enlarged Document

You can reduce or enlarge the size of a document by a specific percentage.

Windows

Set the **Document Size** on the **More Options** tab. Select **Reduce/Enlarge Document**, **Zoom to**, and then enter a percentage.

Mac OS X

Select **Page Setup** from the **File** menu. Select the settings for **Format For** and **Paper Size**, and then enter a percentage in **Scale**. Close the window, and then print following the basic printing instructions.

Related Information

➔ [“Printing Basics - Mac OS X” on page 55](#)

Printing an Anti-Copy Pattern (for Windows Only)

You can print documents with invisible letters such as "Copy". These letters appear when the document is photocopied so that the copies can be distinguished from the original. You can also add your own anti-copy pattern.

Note:

This feature is only available when the following settings are selected.

- Paper Type: plain papers*
- Quality: Standard*
- Auto 2-sided printing: Disabled*
- Color Correction: Automatic*

Click **Watermark Features** on the **More Options** tab, and then select an anti-copy pattern. Click **Settings** to change details such as the size and density.

Printing a Watermark (for Windows Only)

You can print a watermark such as "Confidential" on your printouts. You can also add your own watermark.

Click **Watermark Features** on the **More Options** tab, and then select a watermark. Click **Settings** to change details such as the density and position of the watermark.

Printing

Printing a Header and Footer (for Windows Only)

You can print information such as a user name and printing date as headers or footers.

Click **Watermark Features** in the **More Options** tab, and then select **Header/Footer**. Click **Settings** and select necessary items from the drop-down list.

Setting a Password for a Print Job (for Windows Only)

You can set a password for a print job to prevent printing until the password is entered on the printer's control panel.

Select **Confidential Job** on the **More Options** tab, and then enter a password.

To print the job, press the **i** button on the printer's control panel, and then select **Confidential Job**. Select the job and enter the password.

Printing Using a PostScript Printer Driver

Printing Using a PostScript Printer Driver - Windows

1. Load paper in the printer.
2. Open the file you want to print.
3. Access the PostScript printer driver window.
4. Select the orientation you set in the application as the **Orientation** on the **Layout** tab.

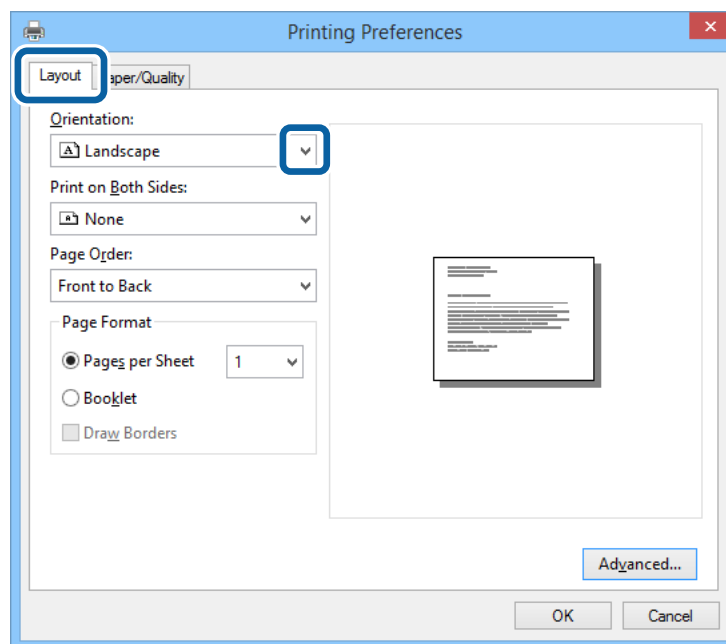

Printing

5. Make the following settings on the **Paper/Quality** tab.

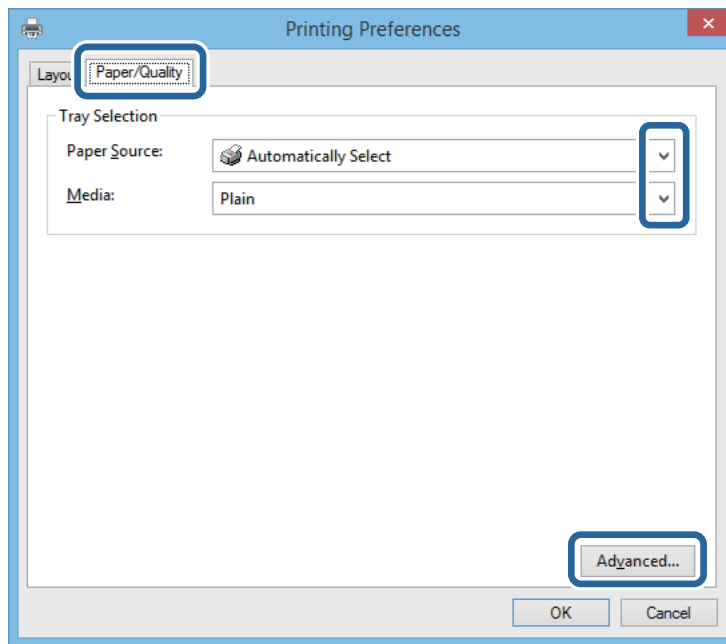

- ❑ Paper Source: Select the paper source in which you loaded the paper.
- ❑ Media: Select the type of paper you loaded.

6. Click **Advanced**, select the paper size you loaded in the printer as the **Paper Size** setting, and then click **OK**.

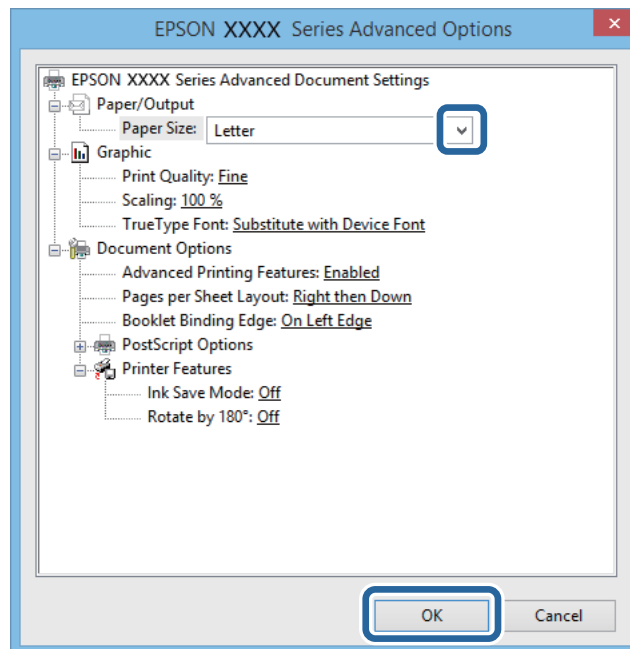

7. Click **OK**.
8. Click **Print**.

Printing

Printing Using a PostScript Printer Driver - Mac OS X

1. Load paper in the printer.
2. Open the file you want to print.
3. Access the print dialog.

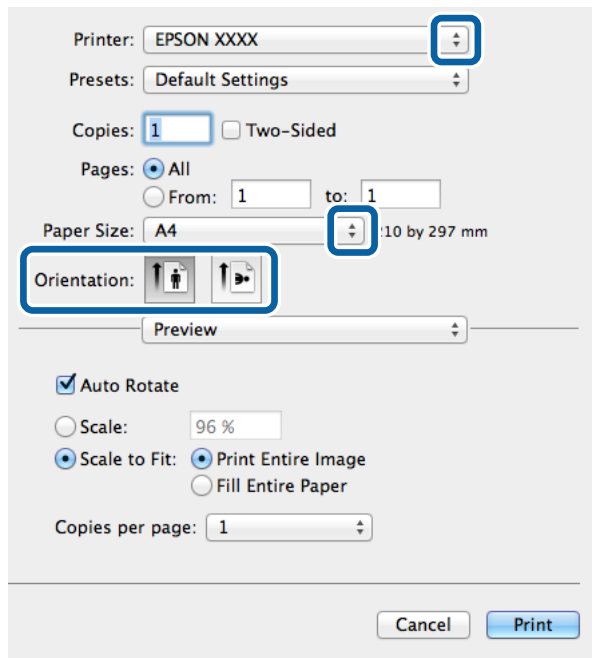

4. Make the following settings.
 - Printer: Select your printer.
 - Paper Size: Select the paper size you loaded in the printer.
 - Orientation: Select the orientation you set in the application.
5. Select **Paper Feed** from the pop-up menu, and then select the paper source in which you loaded the paper.

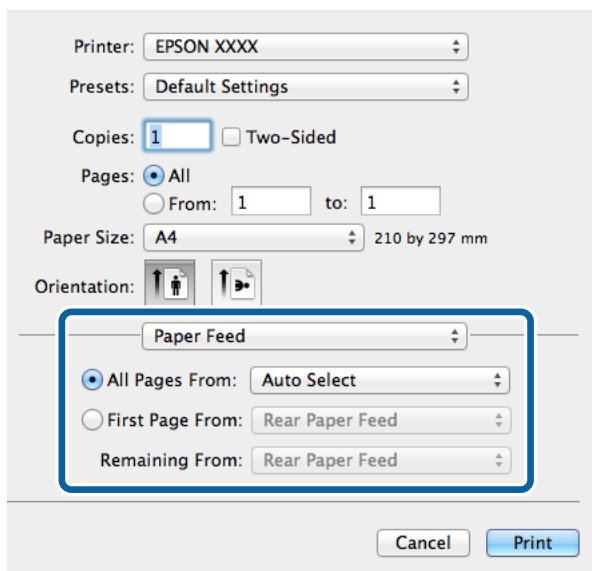

Printing

6. Select **Printer Features** from the pop-up menu, select **Quality** as the **Feature Sets** setting, and then select the type of paper you loaded as the **Media Type** setting.

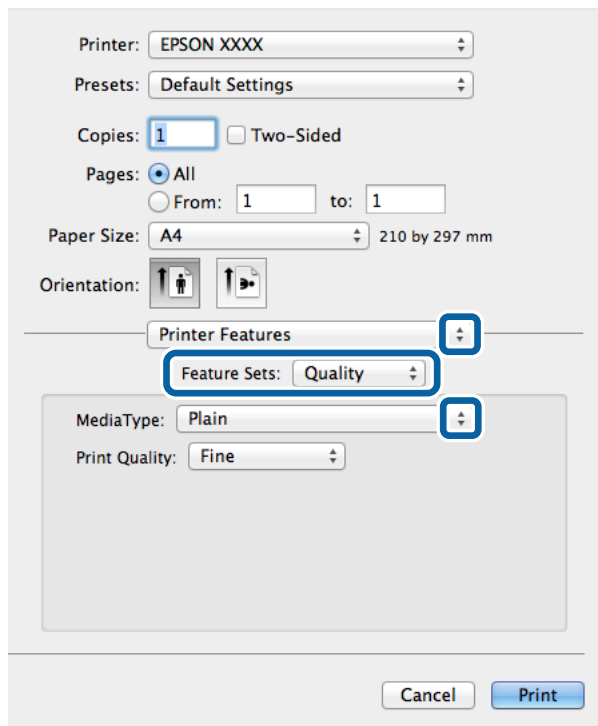

7. Click **Print**.

Setting Items for the PostScript Printer Driver

Note:

The availability of these settings varies by model.

Ink Save Mode	Conserves ink by reducing the print density.
Rotate by 180°	Rotates the data 180 degrees before printing.

Printing from Smart Devices

Using Epson iPrint

Epson iPrint is an application that allows you to print photos, documents, and Web pages from a smart device such as a smartphone or tablet. You can use either local print, printing from a smart device that is connected to the same

Printing

wireless network as your printer, or remote print, printing externally over the internet. To use remote print, register your printer in the Epson Connect service.



You can install Epson iPrint on your smart device from the following URL or QR code.

<http://ipr.to/c>



Using Epson iPrint

Start Epson iPrint from your smart device and select the item you want to use from the home screen. The following screens are subject to change without notice.

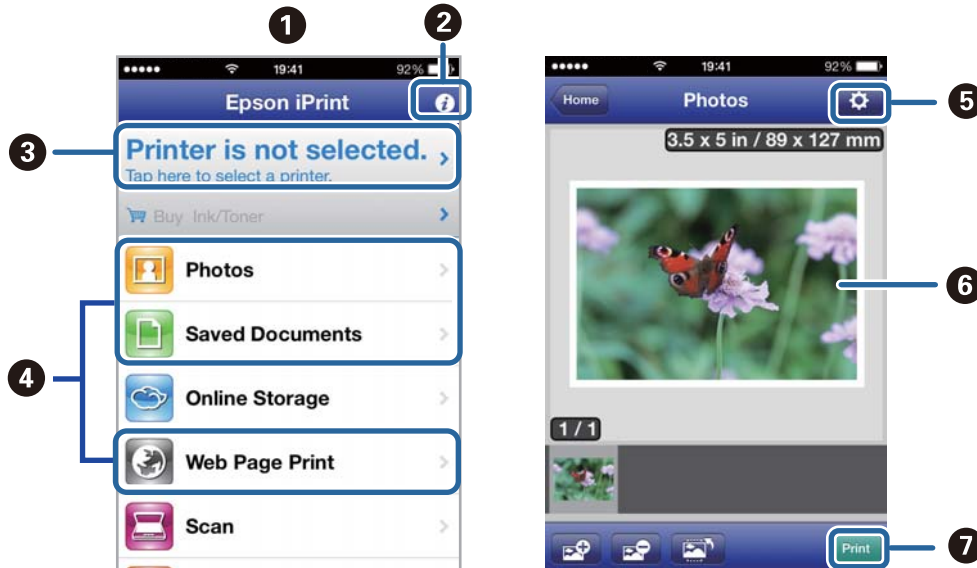

①	Home screen displayed when the application is started.
②	Displays information on how to setup the printer and a FAQ.
③	Displays the screen where you can select the printer and make printer settings. Once you have selected the printer, you do not need to select it again from the next time.
④	Select what you want to print such as photos, documents, and web pages.
⑤	Displays the screen to make print settings such as paper size and paper type.

Printing

6	Displays photos and documents you selected.
7	Starts printing.

Note:

To print from the document menu using iPhone, iPad, and iPod touch running iOS, start Epson iPrint after transferring the document you want to print using the file sharing function in iTunes.

Related Information

➔ [“Epson Connect Service” on page 123](#)

Using AirPrint

AirPrint allows you to wirelessly print to your AirPrint-enabled printer from your iOS device using the latest version of iOS and from your Mac OS X v10.7.x or later.

**Note:**

See the *AirPrint* page of the Apple website for more details.

1. Load paper in the printer.
2. Connect your device to the same wireless network that your printer is using.
3. Print from your device to your printer.

Related Information

- ➔ [“Loading Paper in the Paper Cassette” on page 41](#)
- ➔ [“Loading Paper in the Rear Paper Feed” on page 44](#)

Canceling Printing

Note:

- ❑ *In Windows, you cannot cancel a print job from the computer once it has been completely sent to the printer. In this case, cancel the print job by using the printer's control panel.*
- ❑ *When printing several pages from Mac OS X, you cannot cancel all of the jobs by using the control panel. In this case, cancel the print job from the computer.*
- ❑ *If you have sent a print job from Mac OS X v10.6.8 through the network, you may not be able to cancel printing from the computer. In this case, cancel the print job by using the printer's control panel. You need to change settings in Web Config to cancel printing from the computer. See the Network Guide for more details.*

Canceling Printing - Printer Button

Press the  button to cancel the print job in progress.

Canceling Printing - Status Menu

1. Press the **i** button to display **Status Menu**.
2. Select **Job Monitor > Print Job**.
Ongoing jobs and jobs that are standing by are shown in the list.
3. Select the job that you want to cancel.
4. Press **Cancel**.

Canceling Printing - Windows

1. Access the printer driver window.
2. Select the **Maintenance** tab.
3. Click **Print Queue**.
4. Right-click on the job you want to cancel and then select **Cancel**.

Related Information

➔ [“Windows Printer Driver” on page 125](#)

Canceling Printing - Mac OS X

1. Click the printer icon in the **Dock**.
2. Select the job you want to cancel.
3. Cancel the job.
 - ❑ Mac OS X v10.8.x to Mac OS X v10.9.x

Printing

Click  next to the progress meter.

Mac OS X v10.6.8 to v10.7.x

Click **Delete**.

Copying

1. Load paper in the printer.
2. Place the originals.
3. Enter **Copy** from the home screen.
4. Enter the number of copies by using the numeric keypad.
5. Press **Layout**, and then select the appropriate layout.
6. Make other settings as necessary. You can make detailed settings by pressing **Settings**.

Note:

Press **Preset** to save your settings as a preset.

Press **Preview** to preview the copy results. However, you cannot preview when you have placed the originals on the ADF.

7. Press the  button.

Related Information

- ➔ [“Loading Paper in the Paper Cassette” on page 41](#)
- ➔ [“Loading Paper in the Rear Paper Feed” on page 44](#)
- ➔ [“Placing Originals” on page 47](#)
- ➔ [“Copy Mode” on page 22](#)
- ➔ [“Presets Mode” on page 37](#)

Scanning

Scanning Using the Control Panel

Scanning to an Email

You can send scanned image files by email directly from the printer through a pre-configured email server. Before using this feature, you need to configure the email server.

You can specify the email address by entering directly, but it may be easier if you register the email address in the contacts list first.

Note:

- Before you use this feature, make sure the printer's **Date/Time** and **Time Difference** settings are correct. Access the menus from **System Administration > Common Settings**.
- By using the **Document Capture Pro** function on the control panel instead of this function, you can send emails directly. Before using this function, make sure you have registered a job to send emails in Document Capture Pro and that the computer is turned on.

1. Place the originals.
2. Enter **Scan** from the home screen.
3. Select **Email**.
4. Enter the email addresses.
 - To select from the contacts list: Press **Contacts**, press the check box to add a check mark to a contact, and then press **Proceed**.
 - To enter the email address manually: Select **Enter Email Address > Enter Email Address**, enter the email address, and then press the enter key at the bottom-right of the screen.

Note:

You can send emails to up to 10 individual email addresses and groups.

5. Press **Format**, and then select the file format.
6. Press **Menu**, and then make settings for **Email Settings** and **Basic Settings**.

Note:

- You can specify the maximum size for files that can be attached to an email in **Attached File Max Size**.
- When you select PDF as the file format, you can set a password to protect the file. Select **PDF Settings**, and then make settings.
- Press **Preset** to save your settings as a preset.

7. Press the  button.

The scanned image is sent by email.

Related Information

- ➔ [“System Administration” on page 29](#)

Scanning

- ➔ “Configuring an Email Server” on page 185
- ➔ “Managing Contacts” on page 51
- ➔ “Placing Originals” on page 47
- ➔ “Scan Mode” on page 23
- ➔ “Presets Mode” on page 37
- ➔ “Scanning Using Document Capture Pro (for Windows Only)” on page 81

Scanning to a Network Folder or FTP Server

You can save the scanned image to a specified folder on a network. You can specify the folder by entering a folder path directly, but it may be easier if you register the folder information in the contacts list first.

Note:

Before you use this feature, make sure the printer's **Date/Time** and **Time Difference** settings are correct. Access the menus from **System Administration > Common Settings**.

1. Place the originals.
2. Enter **Scan** from the home screen.
3. Select **Network Folder/FTP**.
4. Specify the folder.
 - To select from the contacts list: Press **Contacts**, select a contact, and then press **Proceed**.
 - To enter the folder path directly: Press **Enter Location**. Select **Communication Mode**, enter the folder path as **Location**, and then make other folder settings.

Note:

Enter the folder path in the following format.

When using SMB as the communication mode:

`\\host name\folder name`

When using FTP as the communication mode:

`ftp://host name/folder name`

5. Press **Format**, and then select the file format.
6. Press **Menu**, and then make settings for **File Settings** and **Basic Settings**.

Note:

When you select PDF as the file format, you can set a password to protect the file. Select **PDF Settings**, and then make settings.

Press **Preset** to save your settings as a preset.

7. Press the  button.

The scanned image is saved.

Related Information

- ➔ “System Administration” on page 29
- ➔ “Managing Contacts” on page 51

Scanning

- ➔ “Placing Originals” on page 47
- ➔ “Scan Mode” on page 23
- ➔ “Presets Mode” on page 37

Scanning to a Memory Device

You can save the scanned image to a memory device.

1. Insert a memory device into the printer's external interface USB port.
2. Place the originals.
3. Enter **Scan** from the home screen.
4. Select **Memory Device**.
5. Press **Format**, and then select the file save format.
6. Press **Settings**, and then make scan settings.

Note:

- When you select PDF as the file format, you can set a password to protect the file. Select **PDF Settings**, and then make settings.
- Press **Preset** to save your settings as a preset.

7. Press the  button.

The scanned image is saved.

Related Information

- ➔ “Part Names and Functions” on page 16
- ➔ “Placing Originals” on page 47
- ➔ “Scan Mode” on page 23
- ➔ “Presets Mode” on page 37

Scanning to the Cloud

You can send scanned images to cloud services using Epson Connect.

See the Epson Connect portal website for details.

<https://www.epsonconnect.com/>

<http://www.epsonconnect.eu> (Europe only)

Scanning Using Document Capture Pro (for Windows Only)

You can scan the original using the settings specified in Document Capture Pro.

Note:

- Before scanning, install Document Capture Pro and make settings for the job.
- Before scanning, connect the printer and the computer to the network.

Scanning

1. Place the originals.
2. Enter **Scan** from the home screen.
3. Select **Document Capture Pro**.
4. Press **Select Computer**, and then select the computer registered to the job in Document Capture Pro.

Note:

- If you select **Option** > **Network Scanning Settings**, and enable **Protect with password** in Document Capture Pro, enter a password.
- If you set only one job, proceed to step 6.

5. Select the job.
6. Press the area in which the job content is displayed, and check the job details.
7. Press the  button.
The scanned image is saved.

Related Information

- ➔ [“Placing Originals” on page 47](#)
- ➔ [“Document Capture Pro \(for Windows Only\)” on page 128](#)

Scanning to a Computer (WSD)

Note:

- Before using this feature, you need to setup your computer. See the Network Guide for more details.
- This function is only available for computers running Windows 8.1/Windows 8/Windows 7/Windows Vista.

1. Place the originals.
2. Enter **Scan** from the home screen.
3. Select **Computer (WSD)**.
4. Select a computer.
5. Press the  button.
The scanned image is saved.

Note:

See your computer's documentation for information on where the scanned image is stored on the computer.

Related Information

- ➔ [“Placing Originals” on page 47](#)

Scanning from a Computer

Scan using the scanner driver "EPSON Scan". See the EPSON Scan help for an explanation of each setting item.

Authenticating Users when Using Access Control in EPSON Scan (for Windows Only)

When the access control function is enabled for a printer, you need to enter a user ID and password when scanning. Register a user name and password in EPSON Scan. If you do not know the password, contact your printer administrator.

1. Access the EPSON Scan Settings.
 - Windows 8.1/Windows 8/Windows Server 2012 R2/Windows Server 2012
Enter "EPSON Scan Settings" in the search charm, and then select the displayed icon.
 - Except for Windows 8.1/Windows 8/Windows Server 2012 R2/Windows Server 2012
Click the start button, and select **All Programs** or **Programs > EPSON > EPSON Scan > EPSON Scan Settings**.
2. Click **Access Control**.
3. Enter the user name and the password.

Scanning in Office Mode

You can scan many text documents quickly.

1. Place the originals.
2. Start EPSON Scan.

Scanning

3. Select **Office Mode** from the **Mode** list.

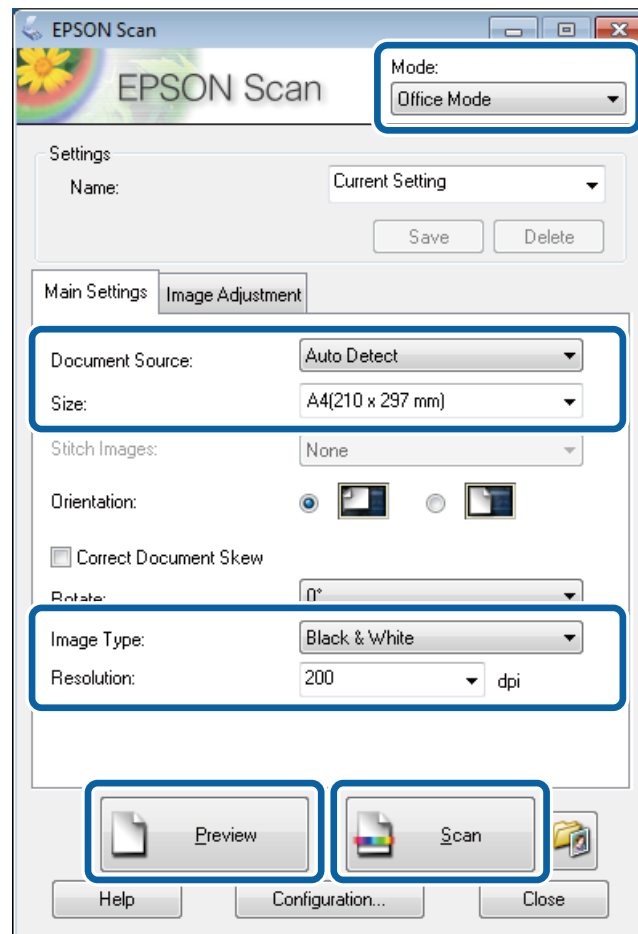

4. Make the following settings on the **Main Settings** tab.
 - Document Source: Select the document source in which you placed your original.
 - Size: Select the size of your original.
 - Image Type: Select the type of image you want to scan.
 - Resolution: Select the resolution of the image you want to scan.

5. Click **Preview**.

The preview window opens.

Note:

If you have placed originals in the ADF, the first page of the originals is ejected when the preview is finished. Place your first document page on top of the rest of the pages, and then load the entire original into the ADF.

6. Confirm the preview, and make settings on the **Image Adjustment** tab as necessary.

Note:

You can adjust the image such as making text enhancements.

7. Click **Scan**.

8. In the **File Save Settings** window, make appropriate settings and then click **OK**.

The scanned image is saved in the specified folder.

Scanning

Note:

When you select PDF as the **Image Format** setting, you can set a password to protect the file. Click **Options**, select the **Security** tab, and then make settings.

Related Information

- ➔ [“Placing Originals” on page 47](#)
- ➔ [“EPSON Scan \(Scanner Driver\)” on page 127](#)

Scanning in Professional Mode

You can scan images while adjusting the quality and color. This mode is recommended for advanced users.

1. Place the originals.
2. Start EPSON Scan.

Scanning

3. Select **Professional Mode** from the **Mode** list.

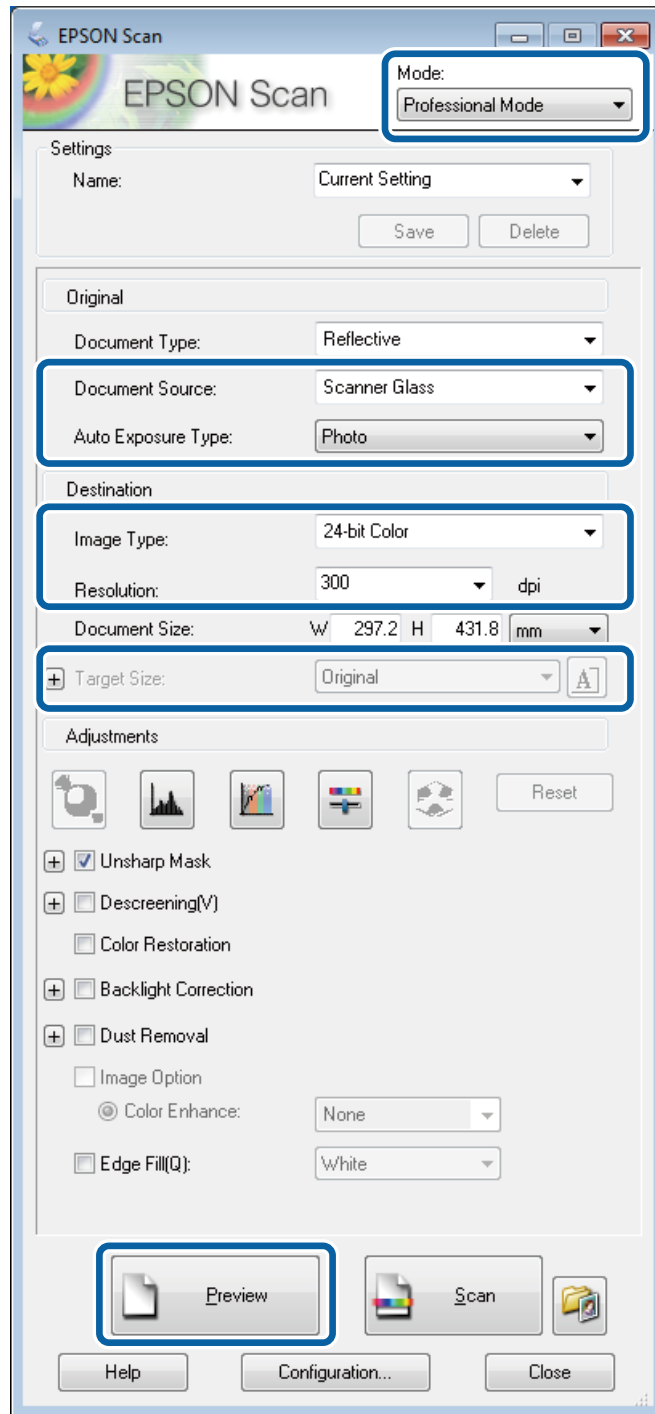

4. Make the following settings.

- Document Source: Select the document source in which you placed your original.
- Auto Exposure Type: Select the exposure type that suits your original.
- Image Type: Select the type of image you want to scan.
- Resolution: Select the resolution of the image you want to scan.
- Target Size: Select the output image size you want to scan to.

Scanning

5. Click **Preview**.

The preview window opens.

Note:

If you have placed originals in the ADF, the first page of the originals is ejected when the preview is finished. Place your first document page on top of the rest of the pages, and then load the entire original into the ADF.

6. Check the preview, and adjust the image as necessary.

Note:

You can make various image adjustments such as improving the color, sharpness, and contrast.

7. Click **Scan**.

8. In the **File Save Settings** window, make appropriate settings and then click **OK**.

The scanned image is saved in the specified folder.

Note:

*When you select PDF as the **Image Format** setting, you can set a password to protect the file. Click **Options**, select the **Security** tab, and then make settings.*

Related Information

- ➔ “Placing Originals” on page 47
- ➔ “EPSON Scan (Scanner Driver)” on page 127

Scanning from Smart Devices

Epson iPrint is an application that allows you to scan photos and documents from a smart device, such as a smartphone or tablet, that is connected to the same wireless network as your printer. You can save the scanned data on a smart device or to Cloud services, send it by email, or print it.

You can install Epson iPrint on your smart device from the following URL or QR code.

<http://ipr.to/c>



Using Epson iPrint

Start Epson iPrint from your smart device and select the item you want to use from the home screen.

Scanning

The following screens are subject to change without notice.

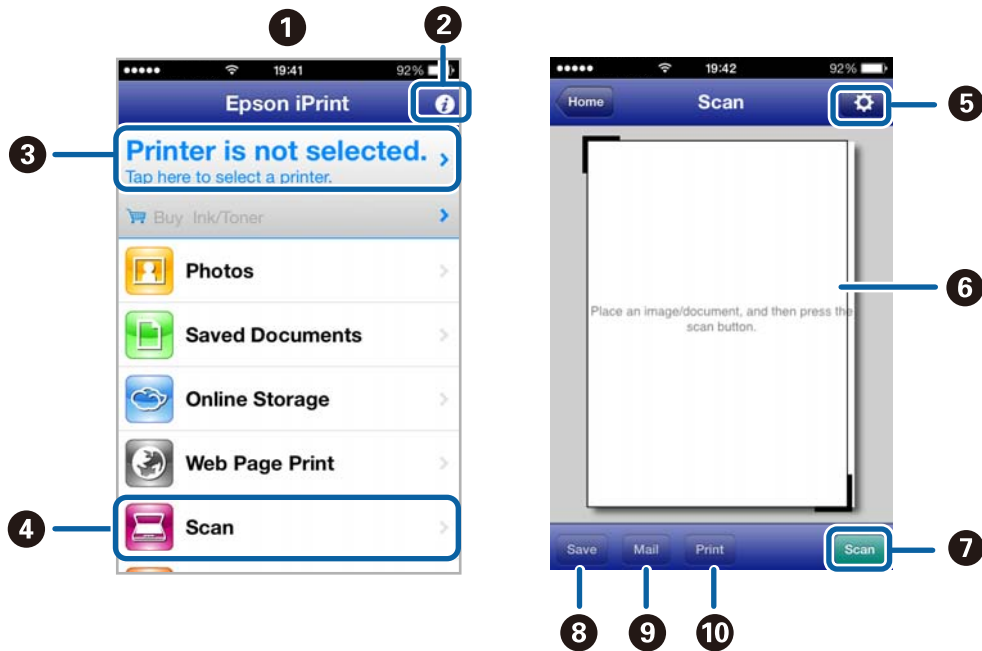

1	Home screen displayed when the application is started.
2	Displays information on how to setup the printer and a FAQ.
3	Displays the screen where you can select the printer and make printer settings. Once you have selected the printer, you do not need to select it again from the next time.
4	Displays the scanning screen.
5	Displays the screen where you can make scan settings such as resolution.
6	Displays scanned images.
7	Starts scanning.
8	Displays the screen where you can save scanned data to a smart device or Cloud services.
9	Displays the screen where you can send scanned data by email.
10	Displays the screen where you can print scanned data.

Related Information

➔ [“Using Epson iPrint” on page 73](#)

Faxing

Setting Up a Fax

Connecting to a Phone Line

Compatible Telephone Lines

You can use the printer over standard analogue telephone lines (PSTN = Public Switched Telephone Network) and PBX (Private Branch Exchange) telephone systems.

You may not be able to use the printer with the following phone lines or systems.

- VoIP phone line such as DSL or fiber-optic digital service
- Digital phone line (ISDN)
- Some PBX telephone systems
- When adapters such as terminal adapters, VoIP adapters, splitters, or DSL router are connected between the telephone wall jack and the printer

Connecting the Printer to a Phone Line

Connect the printer to a telephone wall jack using an RJ-11 (6P2C) phone cable. When connecting a telephone to the printer, use a second RJ-11 (6P2C) phone cable.

Depending on the area, a phone cable may be included with the printer. If it is included, use that cable.

You may need to connect the phone cable to an adapter provided for your country or region.

**Important:**

Remove the cap from the EXT. port of the printer only when connecting your telephone to the printer. Do not remove the cap if you are not connecting your telephone.

In areas where lightning strikes occur frequently, we recommend that you use a surge protector.

Faxing

Connecting to a Standard Phone Line (PSTN) or PBX

Connect a phone cable from the telephone wall jack or PBX port to the LINE port on the back of the printer.

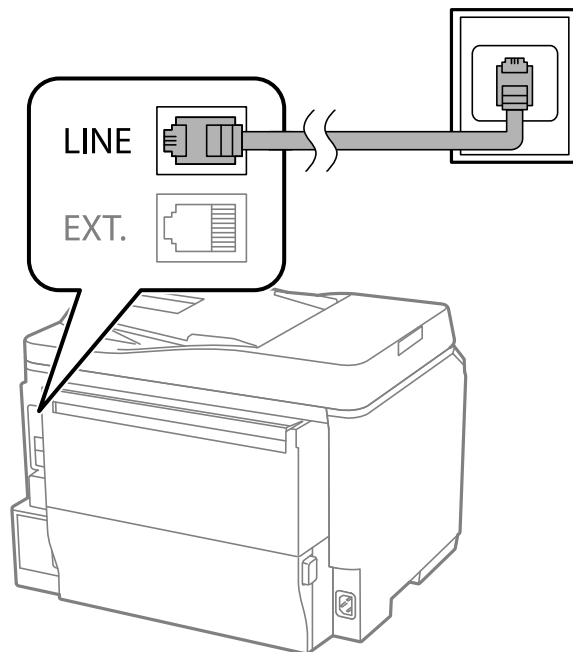

Related Information

➔ [“Making Settings for a PBX Phone System” on page 93](#)

Connecting to DSL or ISDN

Connect a phone cable from the DSL modem or the ISDN terminal adapter to the LINE port on the back of the printer. See the documentation provided with the modem or the adapter for more details.

Note:

If your DSL modem is not equipped with a built-in DSL filter, connect a separate DSL filter.

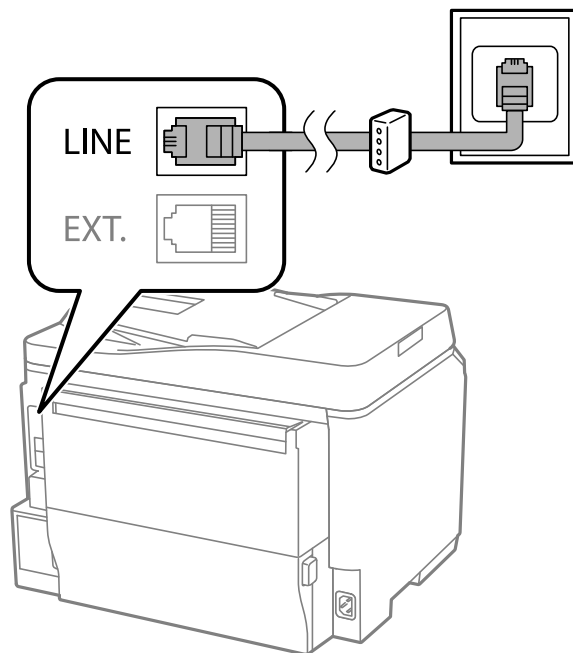

Faxing

Connecting Your Phone Device to the Printer

When using the printer and your telephone on a single phone line, connect the telephone to the printer.

Note:

- ❑ If your phone device has a fax function, disable the fax function before connecting. See the manuals that came with the phone device for details.
- ❑ If you connect an answering machine, make sure the printer's **Rings to Answer** setting is set higher than the number of rings your answering machine is set to answer a call.

1. Remove the cap from the EXT. port on the back of the printer.

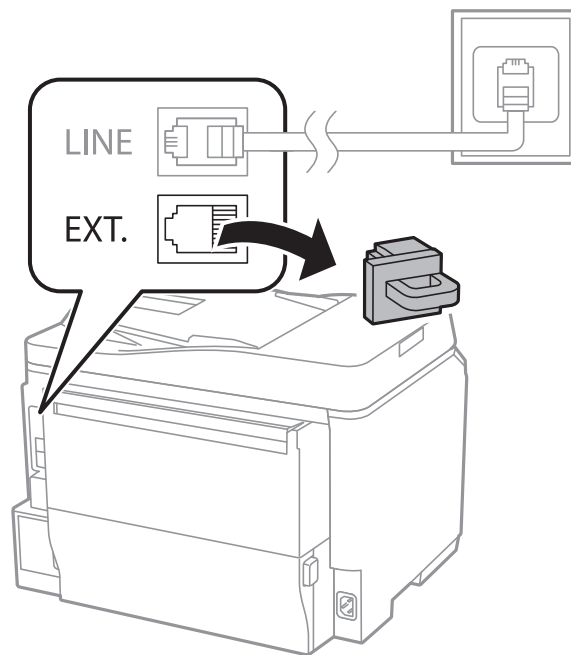

2. Connect the phone device and the EXT. port with a phone cable.

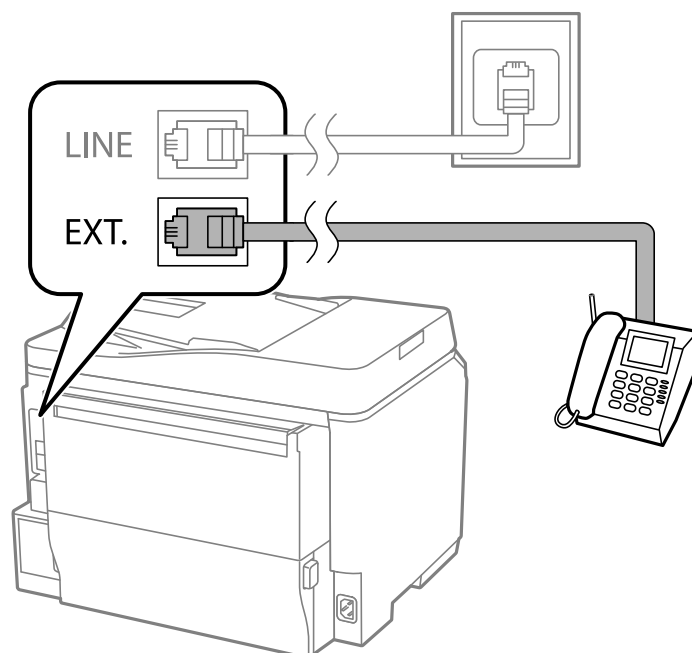

Faxing

 **Important:**

When sharing a single phone line, make sure you connect the phone device to the EXT. port of the printer. If you split the line to connect the phone device and the printer separately, the phone and the printer do not work correctly.

- Pick up the handset of the connected phone device and confirm that the [The phone line is in use.] message is displayed on the LCD screen.

If the message is not displayed, check that the phone cable is securely connected to the EXT. port.

Related Information

➔ [“Settings for the Answering Machine” on page 100](#)

Making Basic Fax Settings

First make basic fax settings such as **Receive Mode** using the **Fax Setting Wizard**, and then configure the other settings as necessary.

The **Fax Setting Wizard** is automatically displayed when the printer is turned on for the first time. Once you have made the settings, you do not need to make them again unless the connection environment is changed.

If an administrator has locked the settings, only the administrator can make the settings.

Making Basic Fax Settings Using the Fax Setting Wizard

Make basic settings by following the on-screen instructions.

- Connect the printer to the phone line.

 **Important:**

Because an automatic fax connection check runs at the end of the wizard, make sure you connect the printer to the phone line before starting the wizard.

- Enter **Setup** from the home screen.
- Select **System Administration > Fax Settings > Fax Setting Wizard**, and then press **Start**.

The wizard begins.

- On the fax header entry screen, enter your sender name such as your company name.

Note:

Your sender name and your fax number appear as the header for outgoing faxes.



- On the phone number entry screen, enter your fax number.

- On the **DRD Setting** screen, make the following settings.

- If you have subscribed to a distinctive ring service from your telephone company: Press **Proceed**, select the ring pattern to be used for incoming faxes, and then go to step 9. **Receive Mode** is automatically set to **Auto**.
- If you do not need to set this option: Press **Skip**, and then go to the next step.

Faxing

Note:

- Distinctive ring services, offered by many telephone companies (the service name differs by company), allows you to have several phone numbers on one phone line. Each number is assigned a different ring pattern. You can use one number for voice calls and another for fax calls. Select the ring pattern assigned to fax calls in **DRD**.*
 - Depending on the region, **On** and **Off** are displayed as the **DRD** options. Select **On** to use the distinctive ring feature.*
7. On the **Receive Mode Setting** screen, select whether you are using your phone device connected to the printer.
 - When connected: Press **Yes**, and go to the next step.
 - When not connected: Press **No** and go to step 9. **Receive Mode** is set to **Auto**.
 8. On the **Receive Mode Setting** screen, select whether you want to receive faxes automatically.
 - To receive automatically: Press **Yes**. **Receive Mode** is set to **Auto**.
 - To receive manually: Press **No**. **Receive Mode** is set to **Manual**.
 9. On the **Confirm Settings** screen, check the settings you made, and then press **Proceed**.
To correct or change settings, press the  button.
 10. Press **Start** to run the fax connection check, and when the screen prompts you to print the check result, press the  button.
A report of the check result that shows the connection status is printed.

Note:

- If there are any errors reported, follow the instructions on the report to solve them.*
- If the **Select Line Type** screen is displayed, select the line type. When you are connecting the printer to a PBX phone system or terminal adapter, select **PBX**.*
- If the **Select Dial Tone Detection** screen is displayed, select **Disable**.
However, setting this to **Disable** may cause the printer to skip the first digit of a fax number when dialing and send the fax to the wrong number.*

Related Information

- ➔ [“Connecting the Printer to a Phone Line” on page 89](#)
- ➔ [“Setting Receiving Mode” on page 100](#)
- ➔ [“Making Settings for a PBX Phone System” on page 93](#)
- ➔ [“Fax Settings” on page 32](#)

Making Basic Fax Settings Individually

You can make fax settings without using the fax setting wizard by selecting each setting menu individually. The settings configured using the wizard can also be changed. For more details, see the list of menus in fax settings.

Related Information

- ➔ [“Fax Settings” on page 32](#)

Making Settings for a PBX Phone System

Make the following settings when using the printer in offices that use extensions and require external access codes, such as 0 and 9, to get an outside line.

Faxing

1. Enter **Setup** from the home screen.
2. Select **System Administration > Fax Settings > Basic Settings > Line Type**.
3. Select **PBX**.
4. On the **Access Code** screen, select **Use**.
5. Press the **Access Code** field, enter the external access code used for your phone system, and then press the enter key at the bottom-right of the screen.

The access code is stored in the printer. When sending a fax to an outside fax number, enter # (hash) instead of the actual access code.

Note:

When # (hash) is entered at the beginning of the fax number, the printer replaces the # with the stored access code when dialing. Using # helps avoid connection problems when connecting to an outside line.

Making Paper Source Settings to Receive Faxes

You can set the printer so that specific paper sources are not used for printing received documents and fax reports. By default, all of the paper sources are enabled for fax printing. Use this feature if you do not want to use paper in a specific paper source for fax printing.

1. Enter **Setup** from the home screen.
2. Select **System Administration > Printer Settings > Paper Source Settings > Auto Select Settings > Fax**.
3. Select the paper source that you do not want to use for printing faxes, and then disable it.

Sending Faxes

Basic Fax Sending Operations

Send faxes in color or monochrome (B&W). When sending a fax in monochrome, you can preview the scanned image on the LCD screen before sending.

Note:

- If the fax number is busy or there is some problem, the printer automatically redials after one minute.*
- You can reserve up to 50 monochrome fax jobs even while the phone line is in use for a voice call, sending another fax, or receiving a fax. You can check or cancel reserved fax jobs from **Job Monitor** in **Status Menu**.*
- If you have enabled the **Save Failure Data** feature, failed faxes are saved, and you can resend them from **Job Monitor** in **Status Menu**.*

Sending Faxes Using the Control Panel

1. Place the originals.

Note:

You can send up to 100 pages in one transmission; however depending on the remaining amount of memory, you may not be able to send faxes with less than 100 pages.

2. Enter **Fax** from the home screen.

Faxing

3. Specify the recipient.



- To enter manually: Enter numbers using the numerical keypad on the control panel or the LCD screen, and then press the enter key at the bottom-right of the screen.
- To select from the contacts list: Press **Contacts**, press the check box to add a check mark to a contact, and then press **Proceed**.
- To select from the sent fax history: Press **History**, select a recipient, and then press **Menu > Send to this number**.

Note:

- You can send the same monochrome fax to up to 200 recipients. A color fax can only be sent to one recipient at a time.
 - To add a pause (pause for three seconds) during dialing, enter a hyphen by pressing .
 - When **Direct Dialing Restrictions** in **Security Settings** is enabled, you can only select fax recipients from the contacts list or the sent fax history. You cannot manually enter a fax number.
 - If you set an external access code in **Line Type**, enter "#" (hash) instead of the actual external access code at the beginning of the fax number.
 - To delete recipients you entered, display the list of recipients by pressing the field on the screen that shows a fax number or the number of recipients, select the recipient from the list, and then select **Delete from the List**.
4. Press **Menu**, select **Fax Send Settings**, and then make settings such as the resolution and the sending method as necessary.

Note:

- To send 2-sided originals, enable **ADF 2-Sided**. However, you cannot send in color with this setting.
 - Press **Preset** on the fax top screen to save the current settings and the recipients in **Preset**. Recipients may not be saved depending on how you specified the recipients, such as entering a fax number manually.
5. When sending a monochrome fax, press **Preview** on the fax top screen to check the scanned document.

- : Moves the screen in the direction of the arrows.
- : Reduces or enlarges.
- : Moves to the previous or the next page.
- Retry: Cancels the preview.
- View: Displays or hides the operation icons.

Note:

- You cannot send the fax in color after previewing.
 - When **Direct Send** is enabled, you cannot preview.
 - When the preview screen is left untouched for 20 seconds, the fax is sent automatically.
 - The image quality of a sent fax may be different from what you previewed depending on the capability of the recipient machine.
6. Press the  button.

Note:

- To cancel sending, press the  button.
- It takes longer to send a fax in color because the printer performs scanning and sending simultaneously. While the printer is sending a color fax, you cannot use the other features.

Faxing

Related Information

- ➔ [“Placing Originals” on page 47](#)
- ➔ [“Fax Mode” on page 25](#)
- ➔ [“Checking Fax Jobs” on page 106](#)
- ➔ [“Managing Contacts” on page 51](#)
- ➔ [“Presets Mode” on page 37](#)

Sending Faxes Dialing from the External Phone Device

You can send a fax by dialing using the connected telephone when you want to talk over the phone before sending a fax, or when the recipient's fax machine does not switch to the fax automatically.

1. Place the originals.

Note:

You can send up to 100 pages in one transmission.

2. Pick up the handset of the connected telephone, and then dial the recipient's fax number using the phone.
3. Press **Start Fax** on the printer's control panel, and then press **Send**.
4. Press **Menu**, select **Fax Send Settings**, and then make settings such as the resolution and the sending method as necessary.
5. When you hear a fax tone, press the  button, and then hang up the handset.

Note:

When a number is dialed using the connected telephone, it takes longer to send a fax because the printer performs scanning and sending simultaneously. While sending the fax, you cannot use the other features.

Related Information

- ➔ [“Placing Originals” on page 47](#)
- ➔ [“Fax Mode” on page 25](#)

Various Ways of Sending Faxes

Sending Faxes After Confirming the Recipient's Status

You can send a fax while listening to sounds or voices through the printer's speaker while dialing, communicating, and transmitting. You can also use this feature when you want to receive a fax from a fax polling service by following audio guidance.

1. Place the originals.
2. Enter **Fax** from the home screen.
3. Press **On Hook**.

Note:

You can adjust the sound volume of the speaker.

Faxing

- Specify the recipient.
- When you hear a fax tone, press **Send/Receive**, and then press **Send**.

Note:

When receiving a fax from a fax polling service, and you hear the audio guidance, follow the guidance to make the printer operations.

- Press the  button.

Related Information

- ➔ [“Sending Faxes Using the Control Panel” on page 94](#)
- ➔ [“Receiving Faxes by Polling \(Polling Receive\)” on page 102](#)
- ➔ [“Placing Originals” on page 47](#)
- ➔ [“Fax Mode” on page 25](#)

Sending Faxes at a Specified Time (Send Fax Later)

You can set to send a fax at a specified time. Only monochrome faxes can be sent when the time to send is specified.

- Place the originals.
- Enter **Fax** from the home screen.
- Specify the recipient.
- Press **Menu**, and then select **Send Fax Later**.
- Press **On**, enter the time to send the fax, and then press **OK**.
- Press **Menu**, select **Fax Send Settings**, and then make settings such as the resolution and the sending method as necessary.
- Press the  button.

Note:

*To cancel the fax, cancel it from **Job Monitor** in **Status Menu**.*

Related Information

- ➔ [“Sending Faxes Using the Control Panel” on page 94](#)
- ➔ [“Placing Originals” on page 47](#)
- ➔ [“Fax Mode” on page 25](#)
- ➔ [“Checking Fax Jobs” on page 106](#)

Storing a Fax Without Specifying a Recipient (Store Fax Data)

You can store up to 100 pages of a single document in monochrome. This allows you to save the time spent scanning the document when you need to send the same document frequently.

Faxing

1. Place the originals.
2. Enter **Fax** from the home screen.
3. Press **Menu**, select **Store Fax Data**, and then enable the function.
4. Press **Menu**, select **Fax Send Settings**, and then make settings such as the resolution and the sending method as necessary.
5. Press the  (B&W) button.

You can send the stored document from **Job Monitor** in **Status Menu**.

Related Information

- ➔ [“Sending Faxes Using the Control Panel” on page 94](#)
- ➔ [“Placing Originals” on page 47](#)
- ➔ [“Fax Mode” on page 25](#)
- ➔ [“Checking Fax Jobs” on page 106](#)

Sending Faxes on Demand (Polling Send)

You can store up to 100 pages of a single document in monochrome for polling fax. The stored document is sent upon request from another fax machine that has a polling receive feature.

1. Place the originals.
2. Enter **Fax** from the home screen.
3. Press **Menu**, select **Polling Send**, and then enable the function.
4. Press **Menu**, select **Fax Send Settings**, and then make settings such as the resolution and the sending method as necessary.
5. Press the  (B&W) button.

To delete the stored document, delete it from **Job Monitor** in **Status Menu**.

Related Information

- ➔ [“Sending Faxes Using the Control Panel” on page 94](#)
- ➔ [“Placing Originals” on page 47](#)
- ➔ [“Fax Mode” on page 25](#)
- ➔ [“Checking Fax Jobs” on page 106](#)

Sending Many Pages of a Monochrome Document (Direct Send)

When sending a fax in monochrome, the scanned document is temporarily stored in the printer's memory. Therefore, sending a lot of pages may cause the printer to run out of memory and stop sending the fax. You can avoid this by enabling the **Direct Send** feature, however, it takes longer to send the fax because the printer performs scanning and sending simultaneously. You can use this feature when there is only one recipient.

Faxing

From the home screen, select **Fax > Menu > Fax Send Settings > Direct Send > On**.

Sending a Fax Preferentially (Priority Send)

You can send an urgent document ahead of the other faxes waiting to be sent.

From the home screen, select **Fax > Menu > Fax Send Settings > Priority Send > On**.

Note:

You cannot send your document preferentially while one of the following is in progress because the printer cannot accept another fax.

- Sending a monochrome fax with Direct Send enabled*
- Sending a color fax*
- Sending a fax using a connected telephone*
- Sending a fax sent from the computer*

Sending Different Size Documents Using ADF (Continuous Scan from ADF)

If you place different sized originals in the ADF, all of the originals are sent at the largest size among them. You can send them in their original sizes by sorting and placing them by size, or placing them one by one.

Before placing originals, select **Fax > Menu > Fax Send Settings > Continuous Scan from ADF > On** from the home screen. Follow the on-screen instructions to place originals.

The printer stores the scanned documents, and sends as one document.

Note:

If you leave the printer untouched for 20 seconds after prompted to set the next originals, the printer stops storing and starts sending the document.

Sending Multiple Faxes to the Same Recipient at Once (Batch Send)

If there are multiple faxes waiting to be sent to the same recipient, you can set the printer to group them together to send them at once. Up to 5 documents (up to 100 pages in total) can be sent at one time. This helps you save on connection fees by reducing the number of transmission times.

From the home screen, select **Setup > System Administration > Fax Settings > Send Settings > Batch Send > On**.

Note:

- Scheduled faxes are also grouped together when the recipient and the time to send the fax match.*
- Batch Send** is not applied to the following fax jobs.
 - Monochrome fax with **Priority Send** enabled*
 - Monochrome fax with **Direct Send** enabled*
 - Color faxes*
 - Faxes sent from the computer*

Sending a Fax from a Computer

You can send faxes from the computer by using the FAX Utility and PC-FAX driver. See the help of FAX Utility and PC-FAX driver for the operating instructions.

Related Information

- ➔ [“PC-FAX Driver \(Fax Driver\)” on page 128](#)
- ➔ [“FAX Utility” on page 128](#)

Receiving Faxes

Setting Receiving Mode

You can set **Receive Mode** using the **Fax Setting Wizard**. When you set up the fax feature for the first time, we recommend using the **Fax Setting Wizard**. If you want to change the **Receive Mode** settings individually, follow the steps below.

1. Enter **Setup** from the home screen.
2. Select **System Administration > Fax Settings > Receive Settings > Receive Mode**.
3. Select how to receive.
 - Auto**: Recommended for heavy fax users. The printer automatically receives a fax after the number of rings you specified.

**Important:**

*When you do not connect a telephone to the printer, select the **Auto** mode.*

- Manual**: Recommended for users who do not fax often, or who want to receive a fax after answering calls with the connected telephone. When receiving a fax, pick up the handset, and then operate the printer.

Note:

*If you enable the **Remote Receive** feature, you can start receiving a fax just by using the connected telephone.*

Related Information

- ➔ [“Making Basic Fax Settings Using the Fax Setting Wizard” on page 92](#)
- ➔ [“Receiving Faxes Manually” on page 101](#)
- ➔ [“Receiving Faxes Using a Connected Telephone \(Remote Receive\)” on page 101](#)

Settings for the Answering Machine

You need settings to use an answering machine.

- Set the **Receive Mode** of the printer to **Auto**.
- Set the **Rings to Answer** setting of the printer to a higher number than the number of rings for the answering machine. Otherwise, the answering machine cannot receive voice calls to record voice messages. See the manuals that came with the answering machine for its settings.

The **Rings to Answer** setting may not be displayed depending on the region.

Related Information

- ➔ [“Fax Settings” on page 32](#)

Various Ways of Receiving Faxes

Receiving Faxes Manually

When you connect a telephone and set the **Receive Mode** setting of the printer to **Manual**, follow the steps below to receive faxes.

1. When the telephone rings, pick up the handset.
2. When you hear a fax tone, press **Start Fax** on the LCD screen of the printer.

Note:

*When you enable the **Remote Receive** feature, you can only start receiving the fax by operating the telephone.*

3. Press **Receive**.
4. Press the  button, and then hang up the handset.

Related Information

- ➔ [“Receiving Faxes Using a Connected Telephone \(Remote Receive\)” on page 101](#)
- ➔ [“Saving Received Faxes” on page 102](#)
- ➔ [“Making Paper Source Settings to Receive Faxes” on page 94](#)

Receiving Faxes Using a Connected Telephone (Remote Receive)

To receive a fax manually, you need to operate the printer after you pick up the handset of the telephone. By using the **Remote Receive** feature, you can start receiving a fax just by operating the phone.

The **Remote Receive** feature is available for telephones that support tone dialing.

Related Information

- ➔ [“Receiving Faxes Manually” on page 101](#)

Setting Up Remote Receive

1. Enter **Setup** from the home screen.
2. Select **System Administration > Fax Settings > Receive Settings > Remote Receive**.
3. After enabling **Remote Receive**, enter a two digit code (0 to 9, *, and # can be entered) in the **Start Code** field.
4. Press **OK**.

Using Remote Receive

1. When the telephone rings, pick up the handset.
2. When you hear a fax tone, enter the start code using the telephone.
3. After confirming that the printer has started receiving the fax, hang up the handset.

Faxing

Receiving Faxes by Polling (Polling Receive)

You can receive a fax stored on another fax machine by dialing the fax number. Use this feature to receive a document from a fax information service. However, if the fax information service has an audio guidance feature that you need to follow to receive a document, you cannot use this feature.

Note:

*To receive a document from a fax information service that uses audio guidance, just dial the fax number using the **On Hook** feature or the connected telephone, and operate the phone and the printer following the audio guidance.*

1. Enter **Fax** from the home screen.
2. Select **Menu > Polling Receive**, and then enable the function.
3. Enter the fax number.

Note:

*When **Direct Dialing Restrictions** in **Security Settings** is enabled, you can only select fax recipients from the contact list or the sent fax history. You cannot manually enter a fax number.*

4. Press the  button.

Related Information

- ➔ [“Sending Faxes After Confirming the Recipient's Status” on page 96](#)
- ➔ [“Sending Faxes Dialing from the External Phone Device” on page 96](#)

Saving Received Faxes

You can set to save received faxes in the printer's inbox, on a memory device, or on a computer. If none of these are set, received documents are printed automatically.

1. Enter **Setup** from the home screen.
2. Select **System Administration > Fax Settings > Output Settings > Fax Output**.
3. Press **Settings**, select the option you want, and then make settings.

Save to Inbox:

Saves all received documents in the printer's inbox. The stored documents are not automatically printed. You can view the documents on the LCD screen of the printer and print them if needed.

Save to Computer:

On the computer connected to the printer, make settings to save received documents on the computer using FAX Utility. See the help of FAX Utility for more details.

Once the received documents are saved on the computer, they are deleted from the printer. To print the documents automatically while saving them on the computer, select **Yes and Print** on the printer after finishing the FAX Utility settings.

Note:

When the computer is not turned on, the printer temporarily saves the received documents in its memory. If the memory becomes full, the printer cannot send or receive faxes.

Save to Memory Device:

Faxing

Converts received documents into PDF format and saves them in a memory device connected to the printer. Once the received documents are saved in the memory device, they are deleted from the printer. To print the documents automatically while saving them in the memory device, select **Yes and Print** on the printer.

Before using this feature, you need to create a folder in the memory device in which received documents are saved. Select **Other Settings > Create Folder to Save**, and then create a folder.

Note:

Make sure the memory device is connected to the printer. If you leave the device disconnected, sending and receiving faxes may become impossible due to a memory full error because the printer temporarily saves the received documents while the device is disconnected.

Related Information





➔ [“FAX Utility” on page 128](#)

Checking the Received Faxes on the LCD Screen

You can check the received documents saved in the printer's inbox on the LCD screen.

1. On the home screen, check the icon that lights up when there are faxes to be processed, such as new faxes and faxes waiting to be forwarded.
2. Enter **Fax** from the home screen.
3. Select **Open Inbox**.
4. If the inbox has been password protected, enter the inbox password or the administrator password.
5. Select the fax to view from the list.

The contents of the fax are displayed.

- : Rotates the image to the right by 90 degrees.
- : Moves the screen in the direction of the arrows.
- : Reduces or enlarges.
- : Moves to the previous or the next page.
- View: Displays or hides the operation icons.

6. Press **Menu**, select whether to print or delete the document you have viewed, and then follow the on-screen instructions.

Note:

The printer cannot receive and send faxes when the memory is full. We recommend deleting the viewed or printed documents.

Related Information

➔ [“Icons Displayed on the LCD Screen” on page 20](#)

➔ [“Fax Settings” on page 32](#)

Forwarding Received Faxes

You can set to forward received documents to another fax machine, or convert the documents into PDF format and forward them to a shared folder on a network or to an email address. Forwarded documents are deleted from the printer. First register the forwarding destinations to the contacts list. To forward to an email address, you also need to configure the email server settings.

Note:

Before you use this feature, make sure the printer's **Date/Time** and **Time Difference** settings are correct. Access the menus from **System Administration > Common Settings**.

1. Enter **Setup** from the home screen.
2. Select **System Administration > Fax Settings > Output Settings > Fax Output**.
3. Press **Settings** and then select **Forward > Yes**.

Note:

To print the documents automatically while forwarding them, select **Yes and Print**.

4. Select **Other Settings > Where to Forward**.
5. Select forwarding destinations from the contacts list.

Note:

 - Press **View** to sort the contacts by printer's feature.
 - You can specify up to five forwarding destinations. Press the check box to select the destination. Press the box again to cancel the selection.
6. When finished selecting forwarding destinations, press **Proceed**.
7. Check that the forwarding destinations you selected are correct, then press **Close**.
8. Select **Options When Forwarding Failed**.
9. Select whether to print received documents or save them in the printer's inbox when forwarding them is failed.
10. When forwarding to an email address, you can specify a subject for the email. Select **Email Subject to Forward**, and enter the subject.

Note:

- If you have selected a shared folder on a network or an email address as the forwarding destination, we recommend that you test if you can send a scanned image to the destination in scan mode. Select **Scan > Email**, or **Scan > Network Folder/FTP** from the home screen, select the destination, and then start scanning.
- You can set to receive a new fax notification on a computer when received documents are saved to a shared folder on a network. Use FAX Utility to make the settings. For details, see the help of FAX Utility.

Related Information

- ➔ [“Managing Contacts” on page 51](#)
- ➔ [“Using an Email Server” on page 184](#)
- ➔ [“Scanning to an Email” on page 79](#)
- ➔ [“Scanning to a Network Folder or FTP Server” on page 80](#)
- ➔ [“FAX Utility” on page 128](#)

Using Other Faxing Features

Printing Fax Report and List

Printing Fax Report Manually

1. Enter **Fax** from the home screen.
2. Select **Menu > Fax Report**.
3. Select the report to print, and then follow the on-screen instruction.

Note:

You can change the report format. From the home screen, select **Setup > System Administration > Fax Settings > Output Settings**, and then change the **Attach Image to Report** or **Report Format** settings.

Related Information

- ➔ [“Fax Mode” on page 25](#)
- ➔ [“Fax Settings” on page 32](#)

Setting Up to Print Fax Reports Automatically

You can make settings to print the following fax reports automatically.

Transmission Report

From the home screen, select **Setup > System Administration > Fax Settings > User Default Settings > Transmission Report**, and then select **Print** or **Print on Error**.

Note:

To change the setting when sending a fax, press **Menu** on the fax top screen, and then select **Fax Send Settings > Transmission Report**.

Forwarding Report

From the home screen, select **Setup > System Administration > Fax Settings > Output Settings > Forwarding Report**, and then select **Print** or **Print on Error**.

Fax Log

From the home screen, select **Setup > System Administration > Fax Settings > Output Settings > Fax Log Auto Print**, and then select **On(Every 30)** or **On(Time)**.

Related Information

- ➔ [“Fax Mode” on page 25](#)
- ➔ [“Fax Settings” on page 32](#)

Setting Security for Faxing

You can make security settings to prevent sending a fax to the wrong recipient, or prevent received documents from being leaked or lost. You can also delete backed-up fax data.

1. Enter **Setup** from the home screen.
2. Select **System Administration > Fax Settings > Security Settings**.
3. Select the menu, and then make the settings.

Related Information

➔ [“Fax Settings” on page 32](#)

Checking Fax Jobs

Checking Fax Jobs in Progress

You can check, cancel, print, resend, or delete the following fax documents.

- Received documents that have not been printed yet.
- Documents that have not be sent yet
- Documents stored using **Polling Send** or **Store Fax Data**.
- Documents that have failed to be sent (if you have enabled **Save Failure Data**)

1. Press the **i** button.
2. Select **Job Monitor**, and then select **Communication Job** or **Print Job**.
3. Select a job to check.

Checking the Fax Job History

You can check the history of sent or received fax jobs. The received fax logs include the received documents so that you can reprint them. You cannot print or resend sent documents from the sent log.

1. Press the **i** button.
2. Select **Job History**, and then select **Receive Job** or **Send Job**.
3. Select a job to check.

Note:

*All the received documents are stored in **Job History** so that you can reprint them, but they are deleted in chronological order when the printer runs out of memory.*

Checking the Received Documents in the Inbox

You can check received documents stored in the printer's inbox.

1. Press the **i** button.

Faxing

2. Select **Job Storage** and then select **Inbox**.

Note:

Press **Menu** to display menus for printing or deleting all the documents in the inbox.

3. Select a fax to check.

The content of the document is displayed.

Note:

Press **Menu**, and then select **Details** to see detailed information such as the date and time, and the sender.

The printer cannot receive and send faxes when the memory is full. We recommend deleting the viewed or printed documents.

Replacing Ink Cartridges and Other Consumables

Checking the Status of the Remaining Ink and the Maintenance Box

You can check the approximate ink levels and the approximate service life of the maintenance box from the control panel or the computer.

Checking the Status of the Remaining Ink and the Maintenance Box - Control Panel

1. Press the **i** button on the control panel.
2. Select **Printer Information**.

Note:

The indicator on the far right indicates the available space in the maintenance box.

Checking the Status of the Remaining Ink and the Maintenance Box - Windows

1. Access the printer driver window.
2. Click **EPSON Status Monitor 3** on the **Maintenance** tab, and then click **Details**.

Note:

*If EPSON Status Monitor 3 is disabled, click **Extended Settings** on the **Maintenance** tab, and then select **Enable EPSON Status Monitor 3**.*

Related Information

➔ [“Windows Printer Driver” on page 125](#)

Checking the Status of the Remaining Ink and the Maintenance Box - Mac OS X

1. Select **System Preferences** from the  menu > **Printers & Scanners** (or **Print & Scan**, **Print & Fax**), and then select the printer.
2. Click **Options & Supplies** > **Utility** > **Open Printer Utility**.
3. Click **EPSON Status Monitor**.

Ink Cartridge Codes

Epson recommends the use of genuine Epson ink cartridges. Epson cannot guarantee the quality or reliability of non-genuine ink. The use of non-genuine ink may cause damage that is not covered by Epson's warranties, and under certain circumstances, may cause erratic printer behavior. Information about non-genuine ink levels may not be displayed.

The following are the codes for genuine Epson ink cartridges.

Black: T8651, T8661

Note:

- Not all cartridges are available in all regions.
- For information on Epson's ink cartridge yields, visit the following website.
<http://www.epson.eu/pageyield>

Ink Cartridge Handling Precautions

Read the following instructions before replacing ink cartridges.

Handling precautions

- Store ink cartridges at normal room temperature and keep them away from direct sunlight.
- Epson recommends using the ink cartridge before the date printed on the package.
- For best results, use up ink cartridge within six months of installation.
- After bringing an ink cartridge inside from a cold storage site, allow it to warm up at room temperature for at least three hours before using it.
- Do not touch the sections shown in the illustration. Doing so may prevent normal operation and printing.

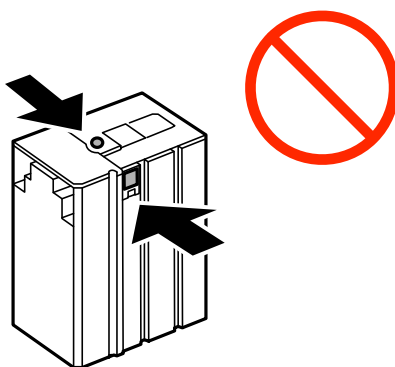

- Do not move the print head by hand; otherwise, you may damage the printer.
- Do not turn off the printer during ink charging. If the ink charging is incomplete, you may not be able to print.
- Do not leave the printer with the ink cartridge removed; otherwise, ink remaining in the print head nozzles may dry out and you may not be able to print.
- If you need to remove an ink cartridge temporarily, make sure you protect the ink supply area from dirt and dust. Store the ink cartridge in the same environment as the printer. Because the ink supply port is equipped with a valve designed to contain the release of excess ink, there is no need to supply your own covers or plugs.

Replacing Ink Cartridges and Other Consumables

- ❑ Removed ink cartridges may have ink around the ink supply port, so be careful not to get any ink on the surrounding area when removing the cartridges.
- ❑ This printer uses ink cartridges equipped with a green chip that monitors information such as the amount of remaining ink for each cartridge. This means that even if the cartridge is removed from the printer before it is expended, you can still use the cartridge after reinserting it back into the printer.
- ❑ To ensure you receive premium print quality and to help protect your print head, a variable ink safety reserve remains in the cartridge when your printer indicates to replace the cartridge. The yields quoted for you do not include this reserve.
- ❑ Although the ink cartridges may contain recycled materials, this does not affect printer function or performance.
- ❑ Specifications and appearance of the ink cartridge are subject to change without prior notice for improvement.
- ❑ Do not disassemble or remodel the ink cartridge, otherwise you may not be able to print normally.
- ❑ Do not drop or knock it against hard objects; otherwise, the ink may leak.
- ❑ You cannot use the cartridge that came with the printer for the replacement.
- ❑ Quoted yields may vary depending on the images that you are printing, the paper type that you are using, the frequency of your prints and environmental conditions such as temperature.

Consumption of Ink

- ❑ To maintain optimum print head performance, some ink is consumed from the cartridge not only during printing but also during maintenance operations such as print head cleaning.
- ❑ The ink in the ink cartridge supplied with your printer is partly used during initial setup. In order to produce high quality printouts, the print head in your printer will be fully charged with ink. This one-off process consumes a quantity of ink and therefore this cartridge may print fewer pages compared to subsequent ink cartridges.

Replacing Ink Cartridges

1. Open the front cover.

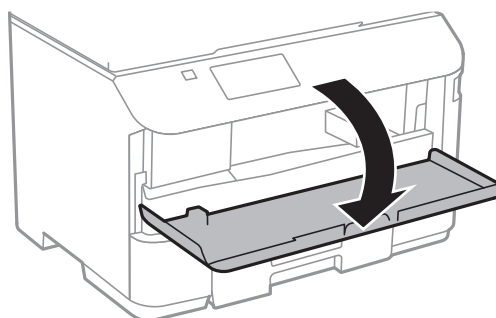

Replacing Ink Cartridges and Other Consumables

2. Push the ink cartridge that you want to replace.

The ink cartridge will pop out slightly.

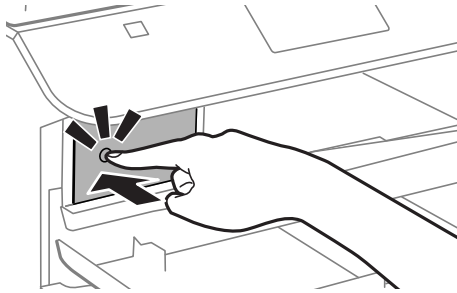

3. Remove the ink cartridge from the printer.

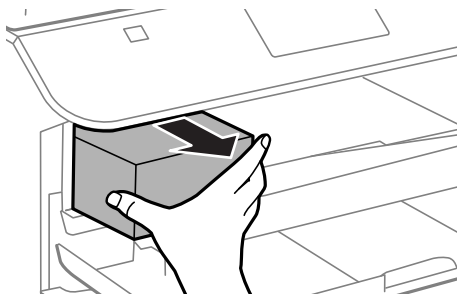

4. Remove the new ink cartridge from its package.

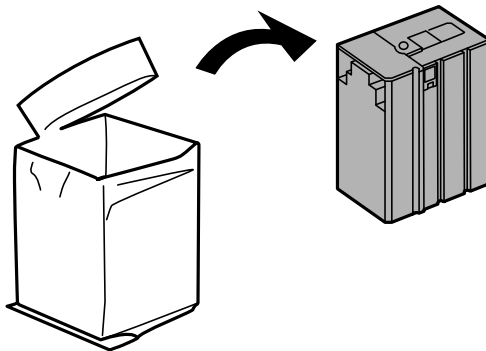

Important:

Do not touch the sections shown in the illustration. Doing so may prevent normal operation and printing.

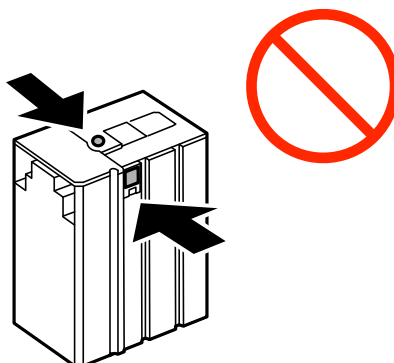

Replacing Ink Cartridges and Other Consumables

5. Shake the ink cartridge horizontally for 5 seconds, moving it back and forth about 10 cm 15 times.

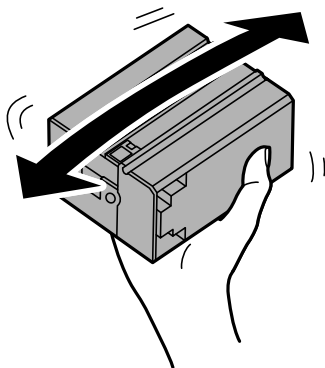

6. Insert the cartridge into the printer until it clicks.

Note:

If **Check** is displayed on the control panel, press it to check if the cartridges are installed correctly.

7. Close the front cover.

Related Information

- ➔ [“Ink Cartridge Codes” on page 109](#)
- ➔ [“Ink Cartridge Handling Precautions” on page 109](#)

Maintenance Box Code

Epson recommends the use of a genuine Epson maintenance box.

The following is the code for the genuine Epson maintenance box.

T6710

Maintenance Box Handling Precautions

Read the following instructions before replacing the maintenance box.

- Do not touch the green chip on the side of the maintenance box. Doing so may prevent normal operation and printing.
- Do not tilt the used maintenance box until after it is sealed in the plastic bag; otherwise ink may leak.
- Keep the maintenance box out of direct sunlight.
- Do not replace the maintenance box during printing; otherwise, ink may leak.
- Do not reuse a maintenance box which has been removed and left detached for a long period. Ink inside the box will have solidified and no more ink can be absorbed.

Replacing a Maintenance Box

In some print cycles a very small amount of surplus ink may be collected in the maintenance box. To prevent ink leakage from the maintenance box, the printer is designed to stop printing when the absorbing capacity of the maintenance box has reached its limit. Whether and how often this is required will vary according to the number of pages you print, the type of material that you print and the number of cleaning cycles that the printer performs. Replace the maintenance box when you are promoted to do so. The Epson Status Monitor, your LCD, or lights on the control panel will advise you when this part needs replacing. The need for replacement of the box does not mean that your printer has ceased to operate in accordance with its specifications. The Epson warranty does not cover the cost of this replacement. It is a user-serviceable part.

Note:

When it is full, you cannot print until the maintenance box is replaced to avoid ink leakage. However, you can perform operations such as sending faxes and saving data to an external USB device.

1. Remove the new maintenance box from its package.

**Important:**

Do not touch the green chip on the side of the maintenance box. Doing so may prevent normal operation and printing.

Note:

A transparent bag for the used maintenance box is provided with the new maintenance box.

2. Remove the rear cover.

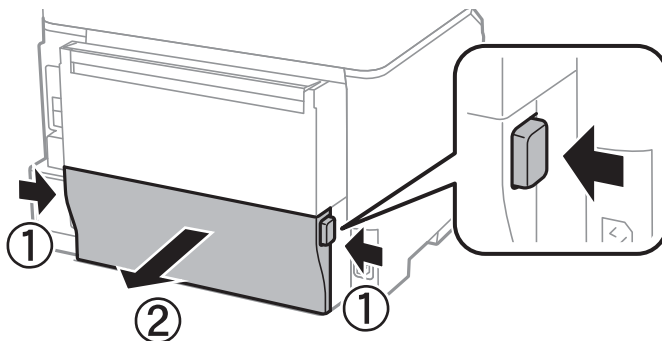

3. Remove the used maintenance box.

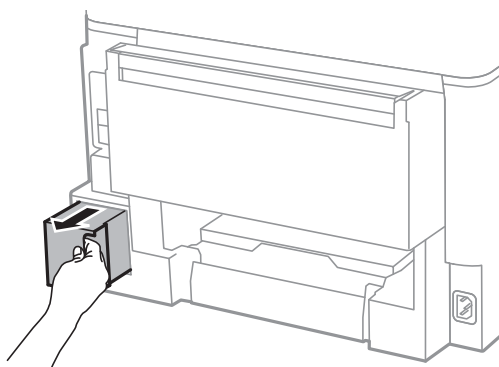

Replacing Ink Cartridges and Other Consumables

- Put the used maintenance box in the transparent bag that came with the new maintenance box and seal the bag shut.

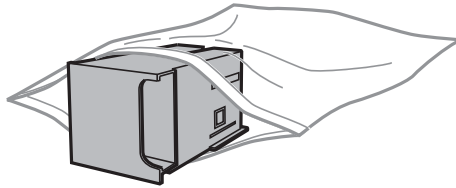

Important:

Do not tilt the used maintenance box until after it is sealed in the plastic bag; otherwise ink may leak.

- Insert the new maintenance box all the way into the printer.
- Insert the rear cover.
- Press Done.

Related Information

- ➔ [“Maintenance Box Code” on page 112](#)
- ➔ [“Maintenance Box Handling Precautions” on page 112](#)

Improving Print and Scan Quality

Checking and Cleaning the Print Head

If the nozzles are clogged, the printouts become faint, or banding may appear. When print quality has declined, use the nozzle check feature and check if the nozzles are clogged. If the nozzles are clogged, clean the print head.

**Important:**

Do not open the front cover or turn off the printer during head cleaning. If the head cleaning is incomplete, you may not be able to print.

Note:

- Because print head cleaning uses some ink, clean the print head only if quality declines.
- When ink is low you may not be able to clean the print head. Replace the appropriate ink cartridge first.
- If print quality has not improved after repeating nozzle check and head cleaning about four times, wait for at least six hours without printing, and then run the nozzle check again and repeat the head cleaning if necessary. We recommend to turn off the printer. If print quality has still not improved, contact Epson support.
- To prevent the print head from drying out, do not unplug the printer while the power is on.
- To keep the print head operating at its best, we recommend printing a few pages on a regular basis.

Checking and Cleaning the Print Head - Control Panel

1. Load A4-size plain paper in the printer.
2. Enter **Setup** from the home screen.
3. Select **Maintenance > Print Head Nozzle Check**.
4. Follow the on-screen instructions to print the nozzle check pattern.

Note:

The test pattern may vary by model.

5. Compare the printed check pattern with the sample shown below.
 - All lines are printed: The print head nozzles are not clogged. Close the nozzle check feature.

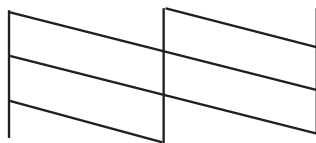

Improving Print and Scan Quality

- ❑ There are broken lines or missing segments: The print head nozzles may be clogged. Go to the next step.

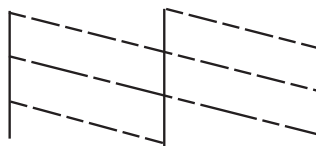

6. Follow the on-screen instructions to clean the print head.
7. When cleaning is finished, print the nozzle check pattern again. Repeat cleaning and printing the pattern until all lines are printed completely.

Related Information

- ➔ [“Loading Paper in the Paper Cassette” on page 41](#)
- ➔ [“Loading Paper in the Rear Paper Feed” on page 44](#)

Checking and Cleaning the Print Head - Windows

1. Load A4-size plain paper in the printer.
2. Access the printer driver window.
3. Click **Nozzle Check** on the **Maintenance** tab.
4. Follow the on-screen instructions.

Related Information

- ➔ [“Loading Paper in the Paper Cassette” on page 41](#)
- ➔ [“Loading Paper in the Rear Paper Feed” on page 44](#)
- ➔ [“Windows Printer Driver” on page 125](#)

Checking and Cleaning the Print Head - Mac OS X

1. Load A4-size plain paper in the printer.
2. Select **System Preferences** from the  menu > **Printers & Scanners** (or **Print & Scan**, **Print & Fax**), and then select the printer.
3. Click **Options & Supplies** > **Utility** > **Open Printer Utility**.
4. Click **Nozzle Check**.
5. Follow the on-screen instructions.

Related Information

- ➔ [“Loading Paper in the Paper Cassette” on page 41](#)

Improving Print and Scan Quality

➔ “Loading Paper in the Rear Paper Feed” on page 44

Aligning the Print Head

If you notice a misalignment of vertical lines or blurred images, align the print head.

Aligning the Print Head - Control Panel

1. Load A4-size plain paper in the printer.
2. Enter **Setup** from the home screen.
3. Select **Maintenance > Print Head Alignment**.
4. Select one of the alignment menus and follow the on-screen instructions to print a pattern for alignment.
 - Ruled Line Alignment: Select this if vertical lines look misaligned.
 - Vertical Alignment: Select this if your printouts look blurry.
 - Horizontal Alignment: Select this if you see horizontal banding at regular intervals.
5. Follow the on-screen instructions to align the print head.

Note:

The alignment patterns may be slightly different from the actual ones, but the procedures are the same.

- Ruled Line Alignment: Find and enter the number for the pattern that has the least misaligned vertical line.

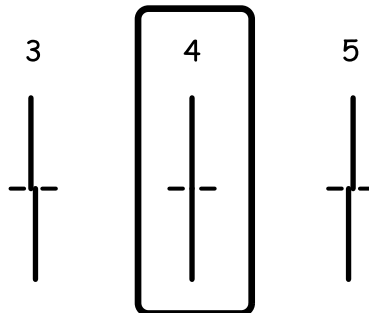

- Vertical Alignment: Find and enter the number for the most solid pattern in each group.

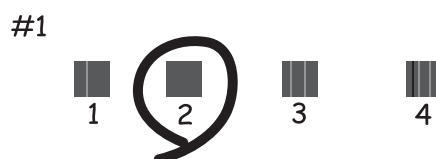

Improving Print and Scan Quality

- ❑ Horizontal Alignment: Find and enter the number for the least separated or overlapping pattern in each group.



Related Information

- ➔ [“Loading Paper in the Paper Cassette” on page 41](#)
- ➔ [“Loading Paper in the Rear Paper Feed” on page 44](#)

Aligning the Print Head - Windows

1. Load A4-size plain paper in the printer.
2. Access the printer driver window.
3. Click **Print Head Alignment** on the **Maintenance** tab.
4. Follow the on-screen instructions.

Related Information

- ➔ [“Loading Paper in the Paper Cassette” on page 41](#)
- ➔ [“Loading Paper in the Rear Paper Feed” on page 44](#)
- ➔ [“Windows Printer Driver” on page 125](#)

Aligning the Print Head - Mac OS X

1. Load A4-size plain paper in the printer.
2. Select **System Preferences** from the  menu > **Printers & Scanners** (or **Print & Scan**, **Print & Fax**), and then select the printer.
3. Click **Options & Supplies** > **Utility** > **Open Printer Utility**.
4. Click **Print Head Alignment**.
5. Follow the on-screen instructions.

Improving Print and Scan Quality

Related Information

- ➔ [“Loading Paper in the Paper Cassette” on page 41](#)
- ➔ [“Loading Paper in the Rear Paper Feed” on page 44](#)

Cleaning the Paper Path for Ink Smears

When the printouts are smeared or scuffed, clean the roller inside.

**Important:**

Do not use tissue paper to clean the inside of the printer. The print head nozzles may be clogged with lint.

1. Load A4-size plain paper in the paper source that you want to clean.
2. Enter **Setup** from the home screen.
3. Select **Maintenance > Paper Guide Cleaning**.
4. Select the paper source, and then follow the on-screen instructions to clean the paper path.

Note:

Repeat this procedure until the paper is not smeared with ink. If the printouts are still smeared or scuffed, clean the other paper sources.

Related Information

- ➔ [“Loading Paper in the Paper Cassette” on page 41](#)
- ➔ [“Loading Paper in the Rear Paper Feed” on page 44](#)

Cleaning the ADF

When the copied or scanned images from the ADF are smeared or the originals do not feed in the ADF correctly, clean the ADF.

**Important:**

Never use alcohol or thinner to clean the printer. These chemicals can damage the printer.

Improving Print and Scan Quality

1. Open the ADF cover.

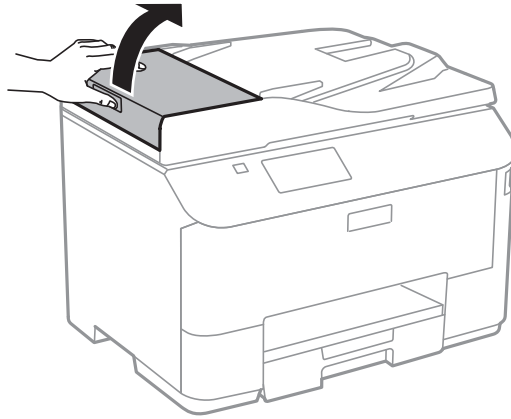

2. Use a soft, dry, clean cloth to clean the roller and the interior of the ADF.

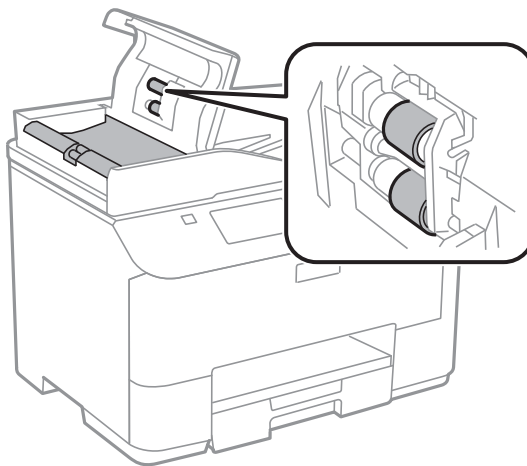

Improving Print and Scan Quality

3. Open the document cover.

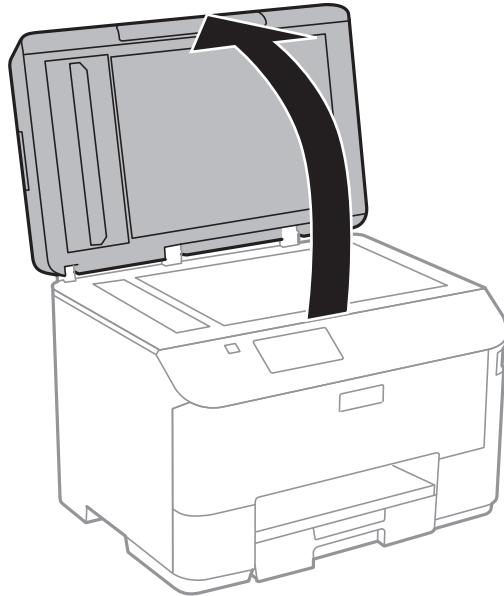

4. Clean the part that is shown in the illustration.

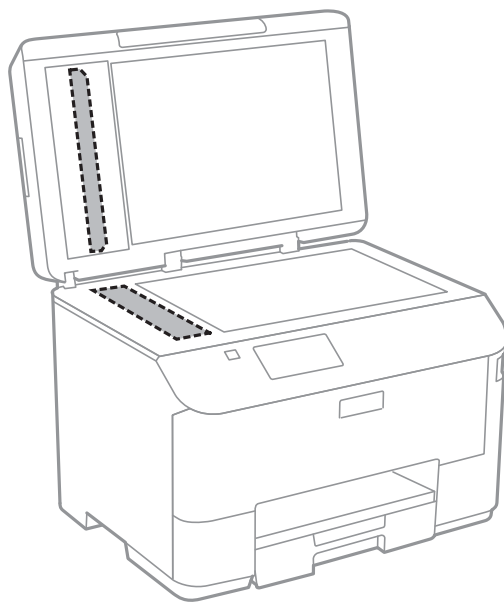

Note:

- ❑ *If the glass surface is stained with grease or some other hard-to-remove material, use a small amount of glass cleaner and a soft cloth to remove it. Wipe off all remaining liquid.*
- ❑ *Do not press the glass surface too hard.*
- ❑ *Be careful not to scratch or damage the surface of the glass. A damaged glass surface can decrease the scan quality.*

Cleaning the Scanner Glass

When the copies or scanned images are smeared or scuffed, clean the scanner glass.



Important:

Never use alcohol or thinner to clean the printer. These chemicals can damage the printer.

1. Open the document cover.

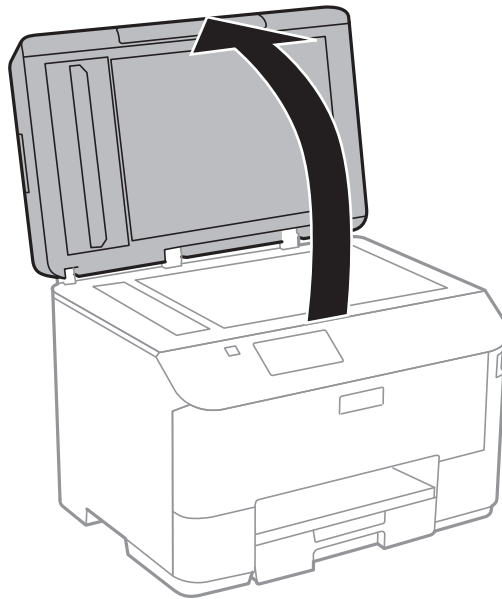

2. Use a soft, dry, clean cloth to clean the surface of the scanner glass.

Note:

- If the glass surface is stained with grease or some other hard-to-remove material, use a small amount of glass cleaner and a soft cloth to remove it. Wipe off all remaining liquid.*
- Do not press the glass surface too hard.*
- Be careful not to scratch or damage the surface of the glass. A damaged glass surface can decrease the scan quality.*

Applications and Network Service Information

Epson Connect Service

By using Epson Connect service available on the Internet, you can print from your smartphone, tablet PC, or laptop, anytime and practically anywhere.

The features available on the Internet are as follows.

Email Print	Epson iPrint remote print	Scan to Cloud	Remote Print Driver
✓	✓	✓	✓

See the Epson Connect portal website for details.

<https://www.epsonconnect.com/>

<http://www.epsonconnect.eu> (Europe only)

Web Config

Web Config is an application that runs on a Web browser, such as Internet Explorer and Chrome, from a computer or smart device. You can confirm the printer status or change the network service and printer settings. To use Web Config, connect the computer or device to the same network as the printer.

Note:

The following browsers are supported.

OS	Browser
Windows XP or later	Internet Explorer 8 or later, Firefox*, Chrome*
Mac OS X v10.5.8 or later	Safari*, Firefox*, Chrome*
iOS*	Safari*
Android 2.3 or later	Default browser
Chrome OS*	Default browser

* Use the latest version.

Running Web Config on a Web Browser

1. Check the printer's IP address.

Press the network icon (for example ) from the home screen, and then check the printer's IP address.

Applications and Network Service Information

2. Launch a Web browser from a computer or smart device, and then enter the printer's IP address.

Format:

IPv4: http://the printer's IP address/

IPv6: http://[the printer's IP address]/

Examples:

IPv4: http://192.168.100.201/

IPv6: http://[2001:db8::1000:1]/

Note:

Using the smart device, you can also run Web Config from the maintenance screen of Epson iPrint.

Related Information

- ➔ [“Using Epson iPrint” on page 73](#)

Running Web Config on Windows

When connecting a computer to the printer using WSD, follow the steps below to run Web Config.

1. Access the devices and printers screen in Windows.
 - Windows 8.1/Windows 8/Windows Server 2012 R2/Windows Server 2012
Select **Desktop > Settings > Control Panel > View devices and printers in Hardware and Sound (or Hardware)**.
 - Windows 7/Windows Server 2008 R2
Click the start button, and select **Control Panel > View devices and printers in Hardware and Sound**.
 - Windows Vista/Windows Server 2008
Click the start button, and select **Control Panel > Printers in Hardware and Sound**.
2. Right-click on your printer and select **Properties**.
3. Select the **Web Service** tab and click the URL.

Running Web Config on Mac OS X

1. Select **System Preferences** from the  menu > **Printers & Scanners** (or **Print & Scan, Print & Fax**), and then select the printer.
2. Click **Options & Supplies > Show Printer Webpage**.

Necessary Applications

Windows Printer Driver

The printer driver is an application that controls the printer according to the print commands from other applications. Making settings on the printer driver provides the best printing results. You can also check the status of the printer or keep it in top operating condition using the printer driver utility.

Note:

You can change the language of the printer driver. Select the language you want to use from the **Language** setting on the **Maintenance** tab.

Accessing the printer driver from applications

To make settings that apply only to the application you are using, access from that application.

Select **Print** or **Print Setup** from the **File** menu. Select your printer, and then click **Preferences** or **Properties**.

Note:

Operations differ depending on the application. See the application's help for details.

Accessing the printer driver from the control panel

To make settings that apply to all of the applications, access from the control panel.

Windows 8.1/Windows 8/Windows Server 2012 R2/Windows Server 2012

Select **Desktop > Settings > Control Panel > View devices and printers** in **Hardware and Sound**. Right-click on your printer, or press and hold it and then select **Printing preferences**.

Windows 7/Windows Server 2008 R2

Click the start button, and select **Control Panel > View devices and printers** in **Hardware and Sound**. Right-click on your printer and select **Printing preferences**.

Windows Vista/Windows Server 2008

Click the start button, and select **Control Panel > Printers** in **Hardware and Sound**. Right-click on your printer and select **Select printing preferences**.

Windows XP/Windows Server 2003 R2/Windows Server 2003

Click the start button, and select **Control Panel > Printers and Other Hardware > Printers and Faxes**. Right-click on your printer and select **Printing preferences**.

Starting the utility

Access the printer driver window. Click the **Maintenance** tab.

Restricting Settings for the Windows Printer Driver

You can lock some settings of the printer driver so that other users cannot change them.

Note:

Log on to your computer as an administrator.

1. Open the **Optional Settings** tab in printer properties.

- Windows 8.1/Windows 8/Windows Server 2012

Applications and Network Service Information

Select **Desktop > Settings > Control Panel > View devices and printers** in **Hardware and Sound**. Right-click on your printer, or press and hold it and then select **Printer properties**. Click the **Optional Settings** tab.

❑ Windows 7/Windows Server 2008 R2

Click the start button, and select **Control Panel > View devices and printers** in **Hardware and Sound**. Right-click on your printer, and then select **Printer properties**. Click the **Optional Settings** tab.

❑ Windows Vista/Windows Server 2008

Click the start button, and select **Control Panel > Printers** in **Hardware and Sound**. Right-click on your printer, and then select **Properties**. Click the **Optional Settings** tab.

❑ Windows XP/Windows Server 2003 R2/Windows Server 2003

Click the start button, and select **Control Panel > Printers and Other Hardware > Printers and Faxes**. Right-click on your printer, and then select **Properties**. Click the **Optional Settings** tab.

2. Click **Driver Settings**.
3. Select the feature that you want to restrict.
See the online help for explanations of the setting items.
4. Click **OK**.

Making Operation Settings for the Windows Printer Driver

You can make settings such as enabling **EPSON Status Monitor 3**.

1. Access the printer driver window.
2. Click **Extended Settings** on the **Maintenance** tab.
3. Make the appropriate settings, and then click **OK**.
See the online help for explanations of the setting items.

Related Information

➔ [“Windows Printer Driver” on page 125](#)

Mac OS X Printer Driver

The printer driver is an application that controls the printer according to the print commands from other applications. Making settings on the printer driver provides the best printing results. You can also check the status of the printer or keep it in top operating condition using the printer driver utility.

Accessing the printer driver from applications

Select **Print** from the **File** menu. If necessary, click **Show Details** (or ▼) to expand the print window.

Note:

Operations differ depending on the application. See the application's help for details.

Applications and Network Service Information

Starting the utility

Select **System Preferences** from the  menu > **Printers & Scanners** (or **Print & Scan, Print & Fax**), and then select the printer. Click **Options & Supplies** > **Utility** > **Open Printer Utility**.

Making Operation Settings for the Mac OS X Printer Driver

You can make various settings such as skipping blank pages and enabling/disabling high speed printing.

1. Select **System Preferences** from the  menu > **Printers & Scanners** (or **Print & Scan, Print & Fax**), and then select the printer. Click **Options & Supplies** > **Options** (or **Driver**).
2. Make the appropriate settings, and then click **OK**.
 - Thick paper and envelopes:** Prevents the ink from smearing when printing on thick paper. However, the print speed may be slower.
 - Skip Blank Page:** Avoids printing blank pages.
 - Quiet Mode:** Prints quietly. However, the print speed may be slower.
 - High Speed Printing:** Prints when the print head moves in both directions. The print speed is faster, but the quality may decline.
 - Warning Notifications:** Allows the printer driver to display warning notifications.
 - Establish bidirectional communication:** Usually, this should be set to **On**. Select **Off** when acquiring the printer information is impossible because the printer is shared with Windows computers on a network or for any other reason.
 - Lower Cassette:** Add the optional paper cassette units to the paper source.

Note:

The availability of these settings varies by model.

EPSON Scan (Scanner Driver)

EPSON Scan is an application for controlling scanning. You can adjust the size, resolution, brightness, contrast, and quality of the scanned image.

Note:

You can also start EPSON Scan from a TWAIN-compliant scanning application.

Starting on Windows

Note:

*For Windows Server operating systems, you need to install the **Desktop Experience** feature.*

- Windows 8.1/Windows 8/Windows Server 2012 R2/Windows Server 2012
Enter the application name in the search charm, and then select the displayed icon.
- Except for Windows 8.1/Windows 8/Windows Server 2012 R2/Windows Server 2012
Click the start button, and select **All Programs** or **Programs** > **EPSON** > **EPSON Scan** > **EPSON Scan**.

Starting on Mac OS X

Note:

EPSON Scan does not support the Mac OS X fast user switching feature. Turn off fast user switching.

Applications and Network Service Information

Select **Go > Applications > Epson Software > EPSON Scan**.

Document Capture Pro (for Windows Only)

Document Capture Pro is an application that allows you to set the method for processing scanned images from a printer connected to the computer over a network.

You can register up to 30 jobs (separation settings after scanning, save format, folders to save, destination, and so on) that you want the software to perform after scanning a document. Registered jobs are can be performed not only from the computer, but also from the control panel of the printer; select **Scan > Document Capture Pro**.

See the Document Capture Pro help for details on using the software.

Note:

- Windows Server operating systems are not supported.*
- You can register up to 100 computers in Document Capture Pro.*

Starting

- Windows 8.1/Windows 8

Enter the application name in the search charm, and then select the displayed icon.

- Windows 7/Windows Vista/Windows XP

Click the start button, and select **All Programs** or **Programs > Epson Software > Document Capture Pro**.

PC-FAX Driver (Fax Driver)

PC-FAX driver is an application that allows you to send a document created on a separate application as a fax directly from the computer. PC-FAX driver is installed when you install FAX Utility. See the application's help for details.

Note:

- Windows Server operating systems are not supported.*
- The operation differs depending on the application you used to create the document. See the application's help for details.*

Accessing from Windows

In the application, select **Print** or **Print Setup** from the **File** menu. Select your printer (FAX), and then click **Preferences** or **Properties**.

Accessing from Mac OS X

In the application, select **Print** from the **File** menu. Select your printer (FAX) as the **Printer** setting, and then select **Fax Settings** or **Recipient Settings** from the pop-up menu.

FAX Utility

FAX Utility is an application that allows you to configure various settings for sending faxes from a computer. You can create or edit the contacts list to be used when sending a fax, configure to save received faxes in PDF format on the computer, and so on. See the application's help for details.

Note:

- Windows Server operating systems are not supported.*
- Before installing the FAX Utility, make sure you have installed the printer driver for this printer; this does not include the PostScript printer driver and Epson universal printer driver.*

Applications and Network Service Information

Starting on Windows

- Windows 8.1/Windows 8

Enter the application name in the search charm, and then select the displayed icon.

- Windows 7/Windows Vista/Windows XP

Click the start button, and select **All Programs** (or **Programs**) > **Epson Software** > **FAX Utility**.

Starting on Mac OS X

Select **System Preferences** from the  menu > **Printers & Scanners** (or **Print & Scan, Print & Fax**), and then select the printer (FAX). Click **Options & Supplies** > **Utility** > **Open Printer Utility**.

E-Web Print (for Windows Only)

E-Web Print is an application that allows you to easily print web pages with various layouts. See the application's help for details. You can access the help from the **E-Web Print** menu on the **E-Web Print** tool bar.

Note:

Windows Server operating systems are not supported.

Starting

When you install E-Web Print, it is displayed in your browser. Click **Print** or **Clip**.

EPSON Software Updater

EPSON Software Updater is an application that checks for new or updated software on the internet and installs it. You can also update the printer's firmware and manual.

Note:

Windows Server operating systems are not supported.

Starting on Windows

- Windows 8.1/Windows 8

Enter the application name in the search charm, and then select the displayed icon.

- Windows 7/Windows Vista/Windows XP

Click the start button, and select **All Programs** (or **Programs**) > **Epson Software** > **EPSON Software Updater**.

Starting on Mac OS X

Select **Go** > **Applications** > **Epson Software** > **EPSON Software Updater**.

EpsonNet Config

EpsonNet Config is an application that allows you to set the network interface addresses and protocols. See the operations guide for EpsonNet Config or the application's help for more details.

Starting on Windows

- Windows 8.1/Windows 8/Windows Server 2012 R2/Windows Server 2012

Enter the application name in the search charm, and then select the displayed icon.

Applications and Network Service Information

- Except for Windows 8.1/Windows 8/Windows Server 2012 R2/Windows Server 2012

Click the start button, and select **All Programs** (or **Programs**) > **EpsonNet** > **EpsonNet Config V4** > **EpsonNet Config**.

Starting on Mac OS X

Select **Go** > **Applications** > **Epson Software** > **EpsonNet** > **EpsonNet Config V4** > **EpsonNet Config**.

Uninstalling Applications

Note:

Log on to your computer as an administrator. Enter the administrator password if the computer prompts you.

Uninstalling Applications - Windows



1. Press the  button to turn off the printer.
2. Quit all running applications.
3. Open **Control Panel**:
 - Windows 8.1/Windows 8/Windows Server 2012 R2/Windows Server 2012
Select **Desktop** > **Settings** > **Control Panel**.
 - Except for Windows 8.1/Windows 8/Windows Server 2012 R2/Windows Server 2012
Click the start button and select **Control Panel**.
4. Open **Uninstall a program** (or **Add or Remove Programs**):
 - Windows 8.1/Windows 8/Windows 7/Windows Vista/Windows Server 2012 R2/Windows Server 2012/
Windows Server 2008 R2/Windows Server 2008
Select **Uninstall a program** in **Programs**.
 - Windows XP/Windows Server 2003 R2/Windows Server 2003
Click **Add or Remove Programs**.
5. Select the application you want to uninstall.
6. Uninstall the applications:
 - Windows 8.1/Windows 8/Windows 7/Windows Vista/Windows Server 2012 R2/Windows Server 2012/
Windows Server 2008 R2/Windows Server 2008
Click **Uninstall/Change** or **Uninstall**.
 - Windows XP/Windows Server 2003 R2/Windows Server 2003
Click **Change/Remove** or **Remove**.

Note:

If the **User Account Control** window is displayed, click **Continue**.

7. Follow the on-screen instructions.

Uninstalling Applications - Mac OS X

1. Download the Uninstaller using EPSON Software Updater.
Once you have downloaded the Uninstaller, you do not need to download it again each time you uninstall the application.
2. Press the  button to turn off the printer.
3. To uninstall the printer driver or PC-FAX driver, select **System Preferences** from the  menu > **Printers & Scanners** (or **Print & Scan, Print & Fax**), and then remove the printer from the enabled printers list.
4. Quit all running applications.
5. Select **Go > Applications > Epson Software > Uninstaller**.
6. Select the application you want to uninstall, and then click **Uninstall**.

**Important:**

The Uninstaller removes all drivers for Epson inkjet printers on the computer. If you use multiple Epson inkjet printers and you only want to delete some drivers, delete all of them first, and then install the necessary printer driver again.

Note:

*If you cannot find the application you want to uninstall in the application list, you cannot uninstall using the Uninstaller. In this situation, select **Go > Applications > Epson Software**, select the application you want to uninstall, and then drag it to the trash icon.*

Related Information

➔ [“EPSON Software Updater” on page 129](#)

Installing Applications

If your computer is connected to a network, install the latest applications available on the website. If you are unable to download the applications from the website, install them from the software disc that came with the printer.

Note:

- Log on to your computer as an administrator. Enter the administrator password if the computer prompts you.
- When reinstalling an application, you need to uninstall it first.

1. Quit all running applications.
2. When installing the printer driver or EPSON Scan, disconnect the printer and the computer temporarily.

Note:

Do not connect the printer and the computer until you are instructed to do so.

3. Install the applications by following the instructions on the website below.

<http://epson.sn>

Applications and Network Service Information

Note:

Install Document Capture Pro from the website below.

<http://support.epson.net/>

http://assets.epson-europe.com/gb/en/document_capture_pro/index.html (Europe)

Related Information

➔ “Uninstalling Applications” on page 130

Installing a PostScript Printer Driver

Installing a PostScript Printer Driver Using USB Interface - Windows

1. Turn off all virus protection applications.
2. Insert the software disc that came with the printer into the computer, and download the "Driver/PostScript/eppsnt.inf" file.

Note:

If your computer does not have a CD/DVD drive, download the printer driver from the Epson support website.

<http://www.epson.eu/Support> (Europe)

<http://support.epson.net/> (outside Europe)

3. Connect the printer to the computer with a USB cable, and then turn on the printer.

Note:

For Windows Vista/Windows XP, when the **Found New Hardware** screen appears, click **Ask me again later**.

4. Add a printer.
 - Windows 8.1/Windows 8/Windows Server 2012 R2/Windows Server 2012
Select **Desktop > Settings > Control Panel > View devices and printers in Hardware and Sound**, and then click **Add a Printer**.
 - Windows 7/Windows Server 2008 R2
Click the start button, select **Control Panel > View devices and printers in Hardware and Sound**, and then click **Add a Printer**.
 - Windows Vista/Windows Server 2008
Click the start button, select **Control Panel > Printers in Hardware and Sound**, and then click **Add a Printer**.
 - Windows XP/Windows Server 2003 R2/Windows Server 2003
Click the start button, select **Control Panel > Printers and Other Hardware > Printers and Faxes > Add a Printer**, and then click **Next**.
5. Add a local printer.
 - Windows 8.1/Windows 8/Windows Server 2012 R2/Windows Server 2012
Click **The printer that I want isn't listed**, select **Add a local printer or network printer with manual settings**, and then click **Next**.
 - Windows 7/Windows Vista/Windows Server 2008 R2/Windows Server 2008
Click **Add a local printer**.

Applications and Network Service Information

- ❑ Windows XP/Windows Server 2003 R2/Windows Server 2003

Select **Local printer attached to this computer**, clear **Automatically detect and install my Plug and Play printer**, and then click **Next**.

6. Select **Use an existing port**, select **USB001 (Virtual printer port for USB)**, and then click **Next**.
7. Click **Have Disk**, specify the "eppsnt.inf" file that is on the software disc or that you have downloaded from the website, and then click **OK**.
8. Select your printer, and then click **Next**.
9. Follow the on-screen instructions for the rest of the installation.

Installing a PostScript Printer Driver Using Network Interface - Windows

1. Select **Setup > Network Status > Wi-Fi/Network Status** on the control panel, and then confirm the IP address.
2. Turn off all virus protection applications.
3. Turn on the printer.
4. Insert the software disc that came with the printer into the computer, and download the "Driver/PostScript/eppsnt.inf" file.

Note:

If your computer does not have a CD/DVD drive, download the printer driver from the Epson support website.

<http://www.epson.eu/Support> (Europe)

<http://support.epson.net/> (outside Europe)

5. Add a printer.

- ❑ Windows 8.1/Windows 8/Windows Server 2012 R2/Windows Server 2012

Select **Desktop > Settings > Control Panel > View devices and printers** in **Hardware and Sound**, and then click **Add a Printer**.

- ❑ Windows 7/Windows Server 2008 R2

Click the start button, select **Control Panel > View devices and printers** in **Hardware and Sound**, and then click **Add a Printer**.

- ❑ Windows Vista/Windows Server 2008

Click the start button, select **Control Panel > Printers** in **Hardware and Sound**, and then click **Add a Printer**.

- ❑ Windows XP/Windows Server 2003 R2/Windows Server 2003

Click the start button, select **Control Panel > Printers and Other Hardware > Printers and Faxes > Add a Printer**, and then click **Next**.

6. Add a local printer.

- ❑ Windows 8.1/Windows 8/Windows Server 2012 R2/Windows Server 2012

Click **The printer that I want isn't listed**, select **Add a local printer or network printer with manual settings**, and then click **Next**.

- ❑ Windows 7/Windows Vista/Windows Server 2008 R2/Windows Server 2008

Click **Add a local printer**.

Applications and Network Service Information

- Windows XP/Windows Server 2003 R2/Windows Server 2003

Select **Local printer attached to this computer**, clear **Automatically detect and install my Plug and Play printer**, and then click **Next**.

7. Select **Create a new port**, select **Standard TCP/IP Port**, and then click **Next**.

Note:

For Windows XP/Windows Server 2003 R2/Windows Server 2003, when the **Add Standard TCP/IP Printer Port Wizard** screen appears, click **Next**.

8. Enter the printer's IP address, and then click **Next**.

Note:

For Windows XP/Windows Server 2003 R2/Windows Server 2003, when the **Add Standard TCP/IP Printer Port Wizard** screen appears, click **Finish**.

9. Click **Have Disk**, specify the "eppsnt.inf" file that is on the software disc or that you have downloaded from the website, and then click **OK**.
10. Select your printer, and then click **Next**.
11. Follow the on-screen instructions for the rest of the installation.

Installing a PostScript Printer Driver - Mac OS X

Download the printer driver from the Epson Support website, and then install it.

<http://www.epson.eu/Support> (Europe)

<http://support.epson.net/> (outside Europe)

You need the IP address of the printer while installing the printer driver. Confirm the IP address by selecting **Setup** > **Network Status** > **Wi-Fi/Network Status** on the control panel.

Adding the Printer Driver (for Mac OS X Only)

1. Select **System Preferences** from the  menu > **Printers & Scanners** (or **Print & Scan**, **Print & Fax**).
2. Click **+**, and then select **Add Other Printer or Scanner**.
3. Select your printer, and then click **Add**.

Note:

If your printer is not listed, check that it is correctly connected to the computer and that the printer is on.

Installing the Epson Universal Printer Driver (for Windows Only)

The Epson universal printer driver is the universal PCL6 compatible print driver that has the following features:

- It supports the basic print functions needed for business situations.
- It supports multiple Epson business printers besides this printer.
- It supports most languages among the print drivers for this printer.

Connect the printer to the same network as the computer, and then follow the procedure below to install the printer driver.

Applications and Network Service Information

1. Download the executable file of the driver from the Epson support website.

<http://www.epson.eu/Support> (Europe)

<http://support.epson.net/> (outside Europe)

Note:

We recommend downloading the latest driver from the website. However you can get it from the software disc that came with the printer. Access to "Driver\Universal".

2. Double-click the executable file that you have downloaded from the website or that is in the software disc.
3. Follow the on-screen instructions for the rest of the installation.

Updating Applications and Firmware

You may be able to clear certain problems and improve or add functions by updating the applications and the firmware. Make sure you use the latest version of the applications and firmware.

1. Make sure that the printer and the computer are connected, and the computer is connected to the internet.
2. Start EPSON Software Updater, and update the applications or the firmware.



Important:

Do not turn off the computer or the printer while updating.

Note:

If you cannot find the application you want to update in the list, you cannot update using the EPSON Software Updater. Check for the latest versions of the applications from your local Epson website.

<http://www.epson.com>

Related Information

- ➔ [“EPSON Software Updater” on page 129](#)

Solving Problems

Checking the Printer Status

You can check error messages and the approximate ink levels on the LCD screen or the computer.

Checking Messages on the LCD Screen

If an error message is displayed on the LCD screen, follow the on-screen instructions or the solutions below to solve the problem.

Error Messages	Solutions
Printer error. Turn the power off and on again. For details, see your documentation.	Remove any paper or protective material in the printer and the paper cassette. If the error message is still displayed after turning the power off and on again, contact Epson support.
You need to replace the following ink cartridge.	To ensure you receive premium print quality and to help protect your print head, a variable ink safety reserve remains in the cartridge when your printer indicates it is time to replace the cartridge. Replace the cartridge when a message prompts you to do so.
Communication error. Please check the Wi-Fi/network connection.	Connect the computer and the printer correctly. If you are connecting over a network, see the <i>Network Guide</i> . If the error message is still displayed, make sure that EPSON Scan and Document Capture Pro are installed on the computer.
No dial tone detected.	This problem might be resolved by selecting Setup > System Administration > Fax Settings > Basic Settings > Line Type , and then selecting PBX . If your phone system requires an external access code to get an outside line, set the access code after selecting PBX . Use # (hash) instead of the actual access code when entering an outside fax number. This makes connection more secure. If the error message is still displayed, set the Dial Tone Detection settings to disabled. However, disabling this feature may drop the first digit of a fax number and send the fax to the wrong number.
Combination of the IP address and the subnet mask is invalid. See your documentation.	See the <i>Network Guide</i> .
Recovery Mode	The printer has started in recovery mode because the firmware update failed. Follow the steps below to try to update the firmware again. 1. Connect the computer and the printer with a USB cable. (During recovery mode, you cannot update the firmware over a network connection.) 2. Visit your local Epson website for further instructions.

Related Information

- ➔ [“Contacting Epson Support” on page 187](#)
- ➔ [“Installing Applications” on page 131](#)
- ➔ [“Updating Applications and Firmware” on page 135](#)

Solving Problems

Error Code on the Status Menu

If a job does not complete successfully, check the error code displayed on the history of each job. You can check the error code by pressing the **i** button, and then selecting **Job History**. See the following table to find the problem and its solution.

Code	Problem	Solution
001	The product was turned off by a power failure.	-
101	The memory is full.	<p>Try the methods below to reduce the size of the print job.</p> <ul style="list-style-type: none"> <input type="checkbox"/> Lower the print quality and the resolution. <input type="checkbox"/> Change the format setting. <input type="checkbox"/> Reduce the number of images, letters or fonts used in the print job.
102	Collated printing has failed due to a lack of available memory.	<ul style="list-style-type: none"> <input type="checkbox"/> Select Setup > System Administration > Clear Internal Memory Data > Clear Font and Macro, and then clear the fonts and the macros that you have downloaded. <input type="checkbox"/> Try the methods below to reduce the size of the print job. If you do not want to use these methods, try printing one copy at a time. <ul style="list-style-type: none"> <input type="checkbox"/> Lower the print quality and the resolution. <input type="checkbox"/> Change the format setting. <input type="checkbox"/> Reduce the number of images, letters or fonts used in the print job.
103	Printing quality has been lowered due to a lack of available memory.	<p>If you do not want to lower the print quality, try the following methods to reduce the size of the print job.</p> <ul style="list-style-type: none"> <input type="checkbox"/> Change the format setting. <input type="checkbox"/> Reduce the number of images, letters or fonts used in the print job.
104	Reverse printing has failed due to a lack of available memory.	<ul style="list-style-type: none"> <input type="checkbox"/> Select Setup > System Administration > Clear Internal Memory Data > Clear Font and Macro, and then clear the fonts and the macros that you have downloaded. <input type="checkbox"/> If you want to print in reverse, try the following methods to reduce the size of the print job. <ul style="list-style-type: none"> <input type="checkbox"/> Lower the print quality and the resolution. <input type="checkbox"/> Change the format setting. <input type="checkbox"/> Reduce the number of images, letters or fonts used in the print job.
106	Cannot print from the computer due to the access control settings.	Contact your printer administrator.

Solving Problems

Code	Problem	Solution
107	User authentication failed. The job has been canceled.	<ul style="list-style-type: none"> <input type="checkbox"/> Make sure that the user name and password are correct. <input type="checkbox"/> Select Setup > System Administration > Security Settings > Access Control. Enable the user restriction function, and then allow the job without an authentication information.
108	Confidential job data was deleted when the product was turned off.	-
109	The received fax was already deleted.	-
110	The job was printed on one side only because the paper loaded does not support double sided printing.	If you want to perform 2-sided printing, load paper that supports 2-sided printing.
111	Available memory is running low.	<p>Try the methods below to reduce the size of the print job.</p> <ul style="list-style-type: none"> <input type="checkbox"/> Lower the print quality and the resolution. <input type="checkbox"/> Change the format setting. <input type="checkbox"/> Reduce the number of images, letters or fonts used in the print job.
201	The memory is full.	<ul style="list-style-type: none"> <input type="checkbox"/> Print received faxes from Job Monitor in Status Menu. <input type="checkbox"/> Delete received faxes saved in the inbox from Job Storage in Status Menu. <input type="checkbox"/> If you are sending a monochrome fax to a single destination, you can send it by using Direct Send. <input type="checkbox"/> Divide your originals in two or more to send them in several batches.
202	The line was disconnected by the recipient machine.	Wait for a while and then try again.
203	The product cannot detect the dial tone.	<ul style="list-style-type: none"> <input type="checkbox"/> Make sure that the phone cable is connected correctly and the phone line is working. <input type="checkbox"/> When the printer is connected to the PBX or the terminal adapter, change the Line Type setting to PBX. <input type="checkbox"/> Select Setup > System Administration > Fax Settings > Basic Settings > Dial Tone Detection, and then disable the dial tone setting.
204	The recipient machine is busy.	Wait for a while and then try again.
205	The recipient machine does not answer.	Wait for a while and then try again.
206	The phone cable is incorrectly connected to the LINE and EXT. port of the product.	Check the connection of the LINE port and the EXT. port of the printer.
207	The product is not connected to the phone line.	Connect the phone cable to the phone line.

Solving Problems

Code	Problem	Solution
208	The fax could not be sent to some of the specified recipients.	Print a Fax Log or Last Transmission report for previous faxes from Fax Report in the Fax mode to check the failed destination. When the Save Failure Data setting is enabled, you can resend a fax from Job Monitor in Status Menu .
301	There is not enough storage space available to save the data in the memory device.	<ul style="list-style-type: none"> <input type="checkbox"/> Increase the storage space in the memory device. <input type="checkbox"/> Reduce the number of documents. <input type="checkbox"/> Lower the scanning resolution or increase the compression ratio to reduce the size of the scanned image.
302	The memory device is write-protected.	Disable write protection on the memory device.
303	No folder has been created to save the scanned image.	Insert another memory device.
304	The memory device has been removed.	Reinsert the memory device.
305	An error occurred while saving the data to the memory device.	If the external device is accessed from a computer, wait for a while and then try again.
306	The memory is full.	Wait until other ongoing jobs are finished.
311	A DNS error has occurred.	<ul style="list-style-type: none"> <input type="checkbox"/> Select Setup > System Administration > Wi-Fi/ Network Settings > Advanced Setup > DNS Server, and then check the DNS settings. <input type="checkbox"/> Check the DNS settings for the server, the computer, or the access point.
312	An authentication error has occurred.	Select Setup > System Administration > Wi-Fi/ Network Settings > Advanced Setup > Email Server > Server Settings , and then check the server settings.
313	A communication error has occurred.	<ul style="list-style-type: none"> <input type="checkbox"/> Select Setup > System Administration > Wi-Fi/ Network Settings > Advanced Setup > Email Server > Server Settings to check the email server settings. You can check the cause of the error by running connection check. <input type="checkbox"/> The authentication method of the settings and the email server may not match. When you select Off as the authentication method, make sure the authentication method of the email server is set to None. <input type="checkbox"/> Check the network connection. See the <i>Network Guide</i> for more details.
314	The data size exceeds the maximum size for attached files.	<ul style="list-style-type: none"> <input type="checkbox"/> Increase the Attached File Max Size setting in the scan settings. <input type="checkbox"/> Lower the scanning resolution or increase the compression ratio to reduce the size of the scanned image.
315	The memory is full.	Retry after other ongoing jobs are finished.

Solving Problems

Code	Problem	Solution
321	A DNS error has occurred.	<ul style="list-style-type: none"> <input type="checkbox"/> Select Setup > System Administration > Wi-Fi/ Network Settings > Advanced Setup > DNS Server, and then check the DNS settings. <input type="checkbox"/> Check the DNS settings for the server, the computer, or the access point.
322	An authentication error has occurred.	Check the Location settings.
323	A communication error has occurred.	<ul style="list-style-type: none"> <input type="checkbox"/> Check the Location settings. <input type="checkbox"/> Check the network connection. See the <i>Network Guide</i> for more details.
324	A file with the same name already exists in the specified folder.	<ul style="list-style-type: none"> <input type="checkbox"/> Delete the file with the same name. <input type="checkbox"/> Change the file name prefix in File Settings.
325	There is not enough storage space available in the specified folder.	<ul style="list-style-type: none"> <input type="checkbox"/> Increase the storage space in the specified folder. <input type="checkbox"/> Reduce the number of documents. <input type="checkbox"/> Lower the scanning resolution or increase the compression ratio to reduce the size of the scanned image.
327	The memory is full.	Wait until other ongoing jobs are finished.
328	The destination was wrong or the destination does not exist.	Check the Location settings.
331	A communication error occurred while acquiring the destination list.	Check the network connection. See the <i>Network Guide</i> for more details.
332	There is not enough storage space available to save the scanned image in the destination storage.	Reduce the number of documents.
333	The destination could not be found because the destination information was uploaded to the server before sending the scanned image.	Select the destination again.
334	An error occurred while sending the scanned image.	-
341	A communication error has occurred.	<ul style="list-style-type: none"> <input type="checkbox"/> Check the connections for the printer and the computer. If you are connecting over a network, see the <i>Network Guide</i>. <input type="checkbox"/> Make sure that Document Capture Pro is installed on the computer.
401	There is not enough storage space available to save the data in the memory device.	Increase the storage space in the memory device.
402	The memory device is write-protected.	Disable write protection on the memory device.
404	The memory device has been removed.	Reinsert the memory device.
405	An error occurred while saving the data to the memory device.	<ul style="list-style-type: none"> <input type="checkbox"/> Reinsert the memory device. <input type="checkbox"/> Use a different memory device on which you have created a folder using the Create Folder to Save function.

Solving Problems

Code	Problem	Solution
411	A DNS error has occurred.	<ul style="list-style-type: none"> <input type="checkbox"/> Select Setup > System Administration > Wi-Fi/ Network Settings > Advanced Setup > DNS Server, and then check the DNS settings. <input type="checkbox"/> Check the DNS settings for the server, the computer, or the access point.
412	An authentication error has occurred.	Select Setup > System Administration > Wi-Fi/ Network Settings > Advanced Setup > Email Server > Server Settings , and then check the server settings.
413	A communication error has occurred.	<ul style="list-style-type: none"> <input type="checkbox"/> Select Setup > System Administration > Wi-Fi/ Network Settings > Advanced Setup > Email Server > Server Settings to check the email server settings. You can check the cause of the error by running connection check. <input type="checkbox"/> The authentication method of the settings and the email server may not match. When you select Off as the authentication method, make sure the authentication method of the email server is set to None. <input type="checkbox"/> Check the network connection. See the <i>Network Guide</i> for more details.
421	A DNS error has occurred.	<ul style="list-style-type: none"> <input type="checkbox"/> Select Setup > System Administration > Wi-Fi/ Network Settings > Advanced Setup > DNS Server, and then check the DNS settings. <input type="checkbox"/> Check the DNS settings for the server, the computer, or the access point.
422	An authentication error has occurred.	Select Setup > System Administration > Fax Settings > Output Settings > Fax Output > Other Settings , and then check the settings of the folder selected in Where to Forward .
423	A communication error has occurred. It is also possible that a file with the same name is open or the file is a read-only file.	<ul style="list-style-type: none"> <input type="checkbox"/> Check the network connection. See the <i>Network Guide</i> for more details. <input type="checkbox"/> Select Setup > System Administration > Fax Settings > Output Settings > Fax Output > Other Settings, and then check the settings of the folder selected in Where to Forward. <input type="checkbox"/> Close the file with the same name or disable the read-only protection.
425	There is not enough storage space available in the forwarding destination folder.	Increase the storage space in the forwarding destination folder.
428	The destination was wrong or the destination does not exist.	Select Setup > System Administration > Fax Settings > Output Settings > Fax Output > Other Settings , and then check the settings of the folder selected in Where to Forward .

Related Information

- ➔ [“Connecting to a Phone Line” on page 89](#)
- ➔ [“Scan Mode” on page 23](#)

- ➔ [“Fax Settings” on page 32](#)
- ➔ [“Available Paper and Capacities” on page 39](#)

Checking the Printer Status - Windows

1. Access the printer driver window.
2. Click **EPSON Status Monitor 3** on the **Maintenance** tab, and then click **Details**.

Note:

*If EPSON Status Monitor 3 is disabled, click **Extended Settings** on the **Maintenance** tab, and then select **Enable EPSON Status Monitor 3**.*

Related Information

- ➔ [“Windows Printer Driver” on page 125](#)

Checking Printer Status - Mac OS X

1. Select **System Preferences** from the  menu > **Printers & Scanners** (or **Print & Scan, Print & Fax**), and then select the printer.
2. Click **Options & Supplies** > **Utility** > **Open Printer Utility**.
3. Click **EPSON Status Monitor**.

Removing Jammed Paper

Check the error displayed on the control panel and follow the instructions to remove the jammed paper including any torn pieces. Next, clear the error.

 **Important:**

Remove the jammed paper carefully. Removing the paper vigorously may cause damage to the printer.

Removing Jammed Paper from the Front Cover

 **Caution:**

Never touch the buttons on the control panel while your hand is inside the printer. If the printer starts operating, it could cause an injury. Be careful not to touch the protruding parts to avoid injury.

Solving Problems

1. Open the front cover.

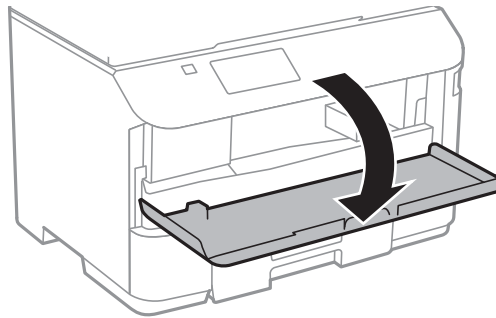

2. Remove the jammed paper.

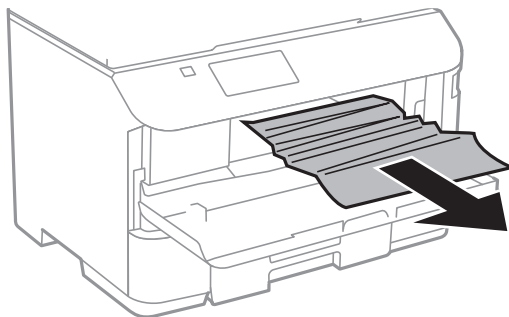

Important:

Do not touch the parts inside the printer. Doing so may cause a malfunction.

3. Close the front cover.

Removing Jammed Paper from the Rear Paper Feed

Remove the jammed paper.



Solving Problems

Removing Jammed Paper from the Paper Cassette

1. Close the output tray.
2. Pull out the paper cassette.

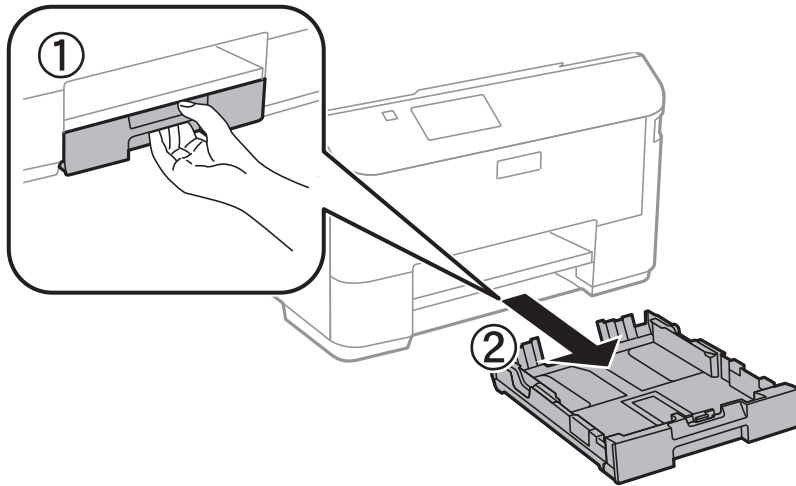

3. Remove the jammed paper.

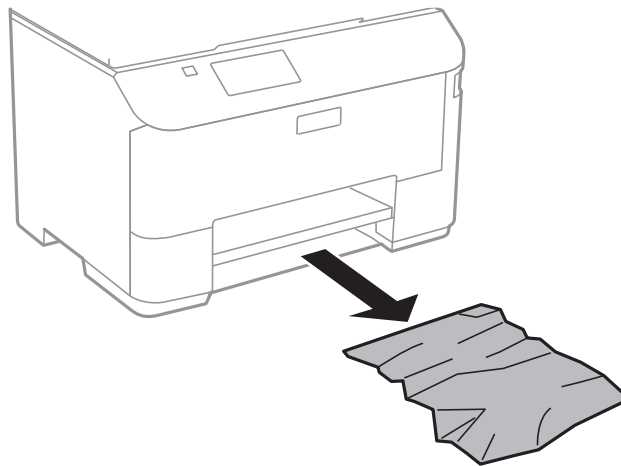

4. Align the edges of the paper and slide the edge guides to the edges of the paper.

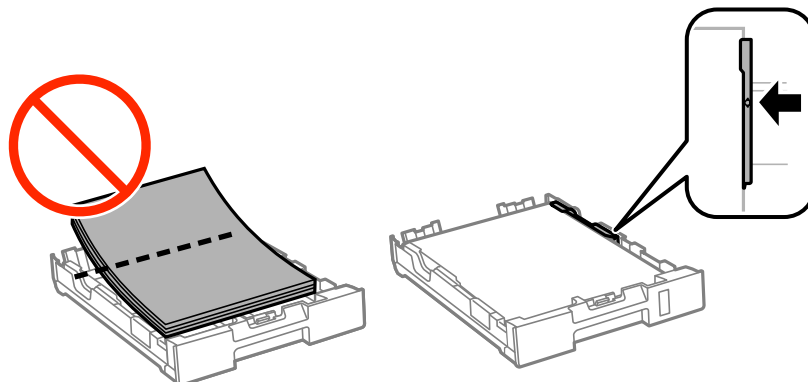

5. Insert the paper cassette in the printer.

Solving Problems

Removing Jammed Paper from Rear Cover

1. Remove the rear cover.

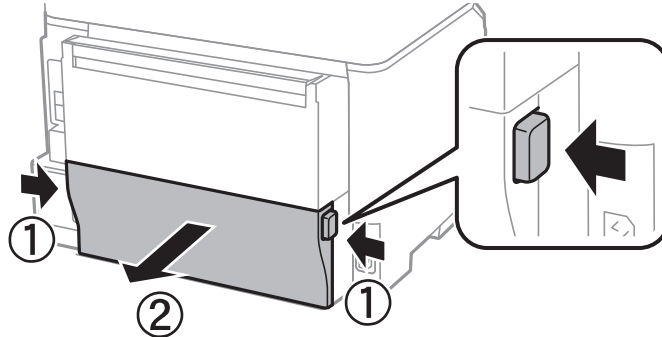

2. Remove the jammed paper.

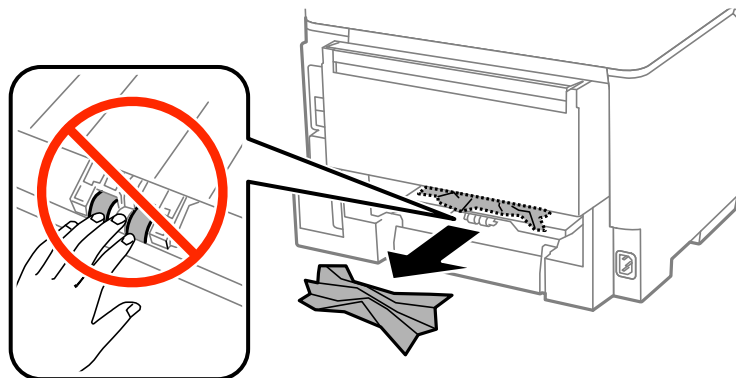

3. Remove jammed paper from the rear cover.

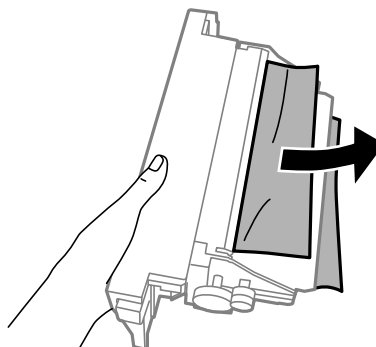

4. Insert the rear cover in the printer.

Removing Jammed Paper from the ADF



Caution:

Be careful not to trap your fingers when closing the document cover. Otherwise you may be injured.

Solving Problems

1. Open the ADF cover.

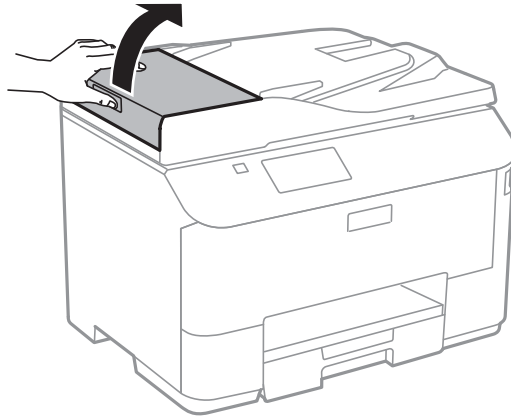

2. Remove the jammed paper.



3. Close the ADF cover.

Solving Problems

4. Open the document cover.

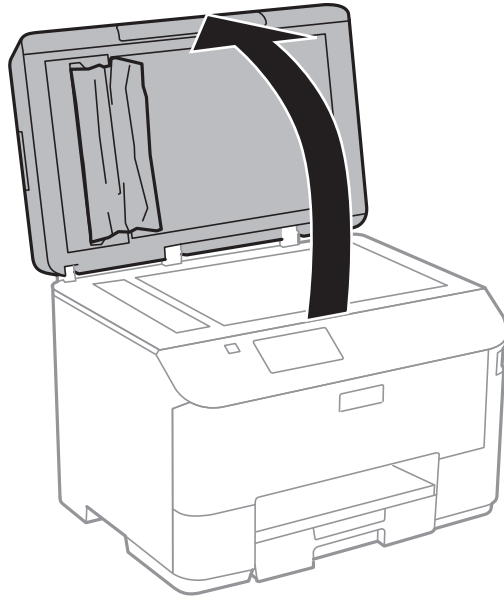

5. Remove the jammed paper.

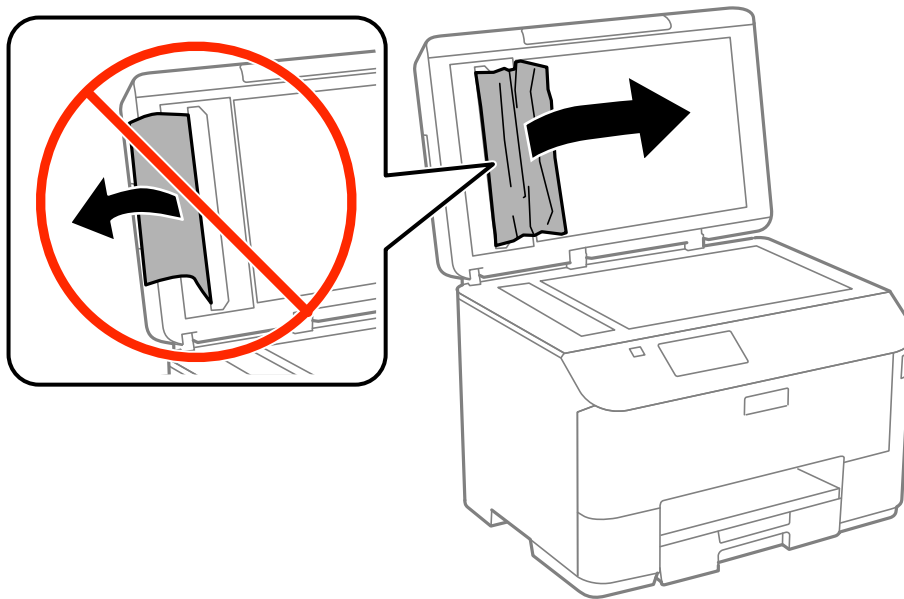

6. Close the document cover.

Solving Problems

7. Raise the ADF input tray, and then remove the jammed paper.

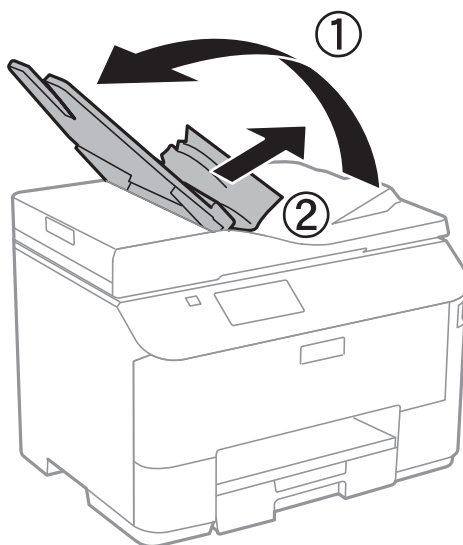

Paper Does Not Feed Correctly

Check the following if the paper jams, paper feeds at a slant, several sheets of paper feed at a time, no paper feeds, or paper is ejected.

- Place the printer on a flat surface and operate in the recommended environmental conditions.
- Use paper supported by this printer.
- Follow the paper handling precautions.
- Load paper in the correct direction, and slide the edge guides against the edges of the paper.
- Do not load more than the maximum number of sheets specified for the paper. For plain paper, do not load above the line just under the ▼ symbol inside the edge guide.
- Insert the paper cassette all the way.
- When a no-paper error occurs although paper is loaded in the rear paper feed, load paper again in the center of the rear paper feed.
- When multiple sheets of paper feed at once during manual 2-sided printing, remove any paper which is loaded in the paper source before you reload the paper.
- Close the front cover if you opened it during printing. Keeping the front cover open during printing pauses the print job.
- Make sure the paper size and paper type settings of the paper source are correct.

Related Information

- ➔ [“Environmental Specifications” on page 171](#)
- ➔ [“Available Paper and Capacities” on page 39](#)
- ➔ [“Paper Handling Precautions” on page 38](#)
- ➔ [“Loading Paper in the Paper Cassette” on page 41](#)
- ➔ [“Loading Paper in the Rear Paper Feed” on page 44](#)

Original Does Not Feed in the ADF

- Use originals supported by the ADF.
- Load originals in the correct direction, and slide the ADF edge guides against the edges of the originals.
- Clean the inside of the ADF.
- Do not load above the line just under the ▼ symbol inside the ADF edge guide.
- Check that the ADF icon appears on the control panel. If it does not appear, place the originals again.

Related Information



- ➔ [“Available Originals for the ADF” on page 47](#)
- ➔ [“Placing Originals on the ADF” on page 47](#)
- ➔ [“Cleaning the ADF” on page 119](#)

Power and Control Panel Problems

Power Does Not Turn On

- Hold down the  button for a little longer.
- Make sure the power cord is securely plugged in.

Power Does Not Turn Off

Hold down the  button for a little longer. If you still cannot turn off the printer, unplug the power cord. To prevent the print head from drying out, turn the printer back on and turn it off by pressing the  button.

LCD Screen Gets Dark

The printer is in sleep mode. Press any button on the control panel to return the LCD screen to its former state.

Printer Does Not Print

Check the following if the printer does not operate or prints nothing.

- When the user feature restriction is enabled, a user ID and password are required to print. If you do not know the password, contact your printer administrator.
- For Mac OS X, the printer may not print when the user feature restriction is enabled. Contact your printer administrator.
- Connect the USB cord securely to the printer and the computer.
- If you are using a USB hub, try to connect the printer directly to the computer.
- If you are using the printer over a network, make sure the printer is connected to the network. You can check the status by checking the indicators on the control panel or by printing the network status sheet. If the printer is not connected to the network, see the *Network Guide*.

Solving Problems

- If you are printing a large data size image, the computer may run out of memory. Print the image at a lower resolution or a smaller size.
- In Windows, click **Print Queue** on the printer driver's **Maintenance** tab, and then check the following.
 - Check if there are any paused print jobs.
Cancel printing if necessary.
 - Make sure the printer is not offline or pending.
If the printer is offline or pending, clear the offline or pending setting from the **Printer** menu.
 - Make sure the printer is selected as the default printer from the **Printer** menu (there should be a check mark on the menu item).
If the printer is not selected as the default printer, set it as the default printer.
- In Mac OS X, make sure the printer status is not **Pause**.
Select **System Preferences** from the  menu > **Printers & Scanners** (or **Print & Scan, Print & Fax**), and then double-click the printer. If the printer is paused, click **Resume** (or **Resume Printer**).
- Perform a nozzle check, and then clean the print head if any of the print head nozzles are clogged.
- If you are using the printer through AirPrint, enable the AirPrint setting on Web Config. If this setting is disabled, you cannot use AirPrint.

Related Information

- ➔ [“Canceling Printing” on page 76](#)
- ➔ [“Checking and Cleaning the Print Head” on page 115](#)

Printout Problems

Print Quality Is Poor

Check the following if the print quality is poor due to blurry prints, banding, missing colors, faded colors, misalignment, and mosaic-like patterns in the prints.

- Use paper supported by this printer.
- Do not print on paper that is damp, damaged, or too old.
- If the paper is curled or the envelope is puffed up, flatten it.
- When printing images or photos, print using high-resolution data. Images on websites are often low resolution although they look good enough on the display, and so print quality may decline.
- Select the appropriate paper type setting on the control panel or in the printer driver for the type of paper loaded in the printer.
- Print using a high quality setting on the control panel or in the printer driver.

Solving Problems

- Disable the bidirectional (or high speed) setting. When this setting is enabled, the print head prints while moving in both directions, and vertical lines may be misaligned. If you disable this feature, printing may slow down.
 - Control panel

When printing JPEGs or TIFFs, press **Settings**, and then disable **Bidirectional**.
 - Windows

Clear **High Speed** on the printer driver's **More Options** tab.
 - Mac OS X

Select **System Preferences** from the  menu > **Printers & Scanners** (or **Print & Scan, Print & Fax**), and then select the printer. Click **Options & Supplies** > **Options** (or **Driver**). Select **Off** as the **High Speed Printing** setting.
- Perform a nozzle check, and then clean the print head if any of the print head nozzles are clogged.
- Align the print head.
- Do not stack the paper immediately after printing.
- Dry the printouts completely before filing or displaying them. When drying the printouts, avoid direct sun light, do not use a dryer, and do not touch the printed side of paper.
- Try to use genuine Epson ink cartridges. This product is designed to adjust colors based on the use of genuine Epson ink cartridges. The use of non-genuine ink cartridges may cause print quality to decline.
- Epson recommends using the ink cartridge before the date printed on the package.
- For best results, use up ink cartridge within six months of installation.
- When printing images or photos, Epson recommends using genuine Epson paper rather than plain paper. Print on the printable side of the genuine Epson paper.

Related Information

- ➔ [“Paper Handling Precautions” on page 38](#)
- ➔ [“List of Paper Types” on page 41](#)
- ➔ [“Checking and Cleaning the Print Head” on page 115](#)
- ➔ [“Aligning the Print Head” on page 117](#)
- ➔ [“Available Paper and Capacities” on page 39](#)

Copy Quality Is Poor

Check the following if uneven colors, smears, dots, or straight lines appear in the copied image.

- Load and eject paper without printing to clean the paper path.
- Clean the scanner glass.
- Clean the ADF.
- Do not press too hard on the original or the document cover when you are placing the originals on the scanner glass. Uneven colors, smears, or dots may appear when the original or the document cover are pressed too hard.
- If a moire (cross-hatch) pattern appears, change the reduce and enlarge setting or place the original at a slightly different angle.

Solving Problems

Related Information

- ➔ [“Cleaning the Paper Path for Ink Smears” on page 119](#)
- ➔ [“Cleaning the Scanner Glass” on page 122](#)
- ➔ [“Cleaning the ADF” on page 119](#)
- ➔ [“Print Quality Is Poor” on page 150](#)

An Image of the Reverse Side of the Original Appears in the Copied Image

- For a thin original, place the original on the scanner glass and then place a piece of black paper over it.
- Lower the copy density setting on the control panel.

The Position, Size, or Margins of the Printout Are Incorrect

- Load paper in the correct direction, and slide the edge guides against the edges of the paper.
- When placing the originals on the scanner glass, align the corner of the original with the corner indicated by a symbol on the frame of the scanner glass. If the edges of the copy are cropped off, move the original slightly away from the corner.
- Clean the scanner glass and the document cover. If there is dust or stains on the glass, the copy area may extend to include the dust or stains, resulting in the wrong printing position or small images.
- Select the appropriate size setting for the original on the control panel.
- Select the appropriate paper size setting on the control panel or in the printer driver.
- Adjust the margin setting in the application so that it falls within the printable area.

Related Information

- ➔ [“Loading Paper in the Paper Cassette” on page 41](#)
- ➔ [“Loading Paper in the Rear Paper Feed” on page 44](#)
- ➔ [“Placing Originals” on page 47](#)
- ➔ [“Cleaning the Scanner Glass” on page 122](#)
- ➔ [“Printable Area” on page 166](#)

Paper Is Smearred or Scuffed

Check the following if the paper is smeared or scuffed when printing.

- Clean the paper path.
- Clean the scanner glass and the document cover.
- Load paper in the correct direction.
- When performing manual 2-sided printing, make sure that the ink is completely dry before reloading the paper.

Solving Problems

- ❑ Enable the reduce smear setting for thick paper. If you enable this feature, print quality may decline or the printing may slow down. Therefore, this feature should normally be disabled.
 - ❑ Control panel
Select **Setup** > **Maintenance** from the home screen, and then enable **Thick Paper**.
 - ❑ Windows
Click **Extended Settings** on the printer driver's **Maintenance** tab, and then select **Thick Paper and Envelopes**.
 - ❑ Mac OS X
Select **System Preferences** from the  menu > **Printers & Scanners** (or **Print & Scan, Print & Fax**), and then select the printer. Click **Options & Supplies** > **Options** (or **Driver**). Select **On** as the **Thick paper and envelopes** setting.
- ❑ When printing high-density data such as images or graphs using automatic 2-sided printing, lower the print density setting and choose a longer drying time.
- ❑ When the paper is smeared during copying, lower the copy density setting on the control panel.

Related Information

- ➔ [“Cleaning the Paper Path for Ink Smears” on page 119](#)
- ➔ [“Cleaning the Scanner Glass” on page 122](#)
- ➔ [“Loading Paper in the Paper Cassette” on page 41](#)
- ➔ [“Loading Paper in the Rear Paper Feed” on page 44](#)
- ➔ [“Copy Mode” on page 22](#)
- ➔ [“Printing on 2-Sides” on page 57](#)
- ➔ [“Print Quality Is Poor” on page 150](#)

Printed Characters Are Incorrect or Garbled

- ❑ Connect the USB cord securely to the printer and the computer.
- ❑ Cancel any paused print jobs.
- ❑ Do not put the computer manually into the **Hibernate** mode or the **Sleep** mode while printing. Pages of garbled text may be printed next time you start the computer.

Related Information

- ➔ [“Canceling Printing” on page 76](#)

The Printed Image Is Inverted

Clear any mirror image settings in the printer driver or the application.

- ❑ Windows
Clear **Mirror Image** on the printer driver's **More Options** tab.
- ❑ Mac OS X
Clear **Mirror Image** from the print dialog's **Layout** menu.

The Printout Problem Could Not be Cleared

If you have tried all of the solutions and have not solved the problem, try uninstalling and then reinstalling the printer driver.



Related Information

➔ [“Uninstalling Applications” on page 130](#)

➔ [“Installing Applications” on page 131](#)

Other Printing Problems

Printing Is Too Slow

- Close any unnecessary applications.
- Lower the quality setting on the control panel or the printer driver. High quality printing slows down the printing speed.
- Enable the bidirectional (or high speed) setting. When this setting is enabled, the print head prints while moving in both directions, and the printing speed increases.
 - Control Panel
When printing JPEGs or TIFFs, press **Settings**, and then enable **Bidirectional**.
 - Windows
Select **High Speed** on the printer driver's **More Options** tab.
 - Mac OS X
Select **System Preferences** from the  menu > **Printers & Scanners** (or **Print & Scan**, **Print & Fax**), and then select the printer. Click **Options & Supplies** > **Options** (or **Driver**). Select **On** as the **High Speed Printing** setting.
- Disable quiet mode. This feature slows down the printing speed.
 - Windows
Select **Off** as the **Quiet Mode** setting on the printer driver's **Main** tab.
 - Mac OS X
Select **System Preferences** from the  menu > **Printers & Scanners** (or **Print & Scan**, **Print & Fax**), and then select the printer. Click **Options & Supplies** > **Options** (or **Driver**). Select **Off** as the **Quiet Mode** setting.

Printing Slows Down Dramatically During Continuous Printing

Printing slows down to prevent the printer mechanism from overheating and being damaged. However, you can continue printing. To return to normal printing speed, leave the printer idle for at least 30 minutes. Printing speed does not return to normal if the power is off.

PostScript Printer Driver Problems

Note:

The menu items and text on the printer driver vary depending on your computer's environment.

Printer Does Not Print While Using PostScript Printer Driver

- Set the **Printing Language** setting to **Auto** or **PS3** on the control panel.
- If you cannot print text data, even when **Text Detection** is enabled on the control panel, set the **Printing Language** setting to **PS3**.
- In Windows, if a large number of jobs are sent, the printer may not print. Select **Print directly to the printer** on the **Advanced** tab in the printer properties.

Related Information

➔ [“System Administration” on page 29](#)

Printer Does Not Print Correctly While Using PostScript Printer Driver

- If the file is created in an application that allows you to change the data format, such as Adobe Photoshop, make sure that the settings in the application match the settings in the printer driver.
- EPS files made in binary format may not be printed correctly. Set the format to ASCII when making EPS files in an application.
- For Windows, the printer cannot print binary data when it is connected to the computer using a USB interface. Set the **Output Protocol** setting on the **Device Settings** tab in the printer properties to **ASCII** or **TBCP**.
- For Windows, select the appropriate substitution fonts on the **Device Settings** tab in the printer properties.

Printing Is Too Slow While Using PostScript Printer Driver

Set the **Print Quality** setting to **Fast** in the printer driver.

Cannot Start Scanning

- When the access control function is enabled for a printer, you need to enter a user ID and password when scanning. If you do not know the password, contact your system administrator.
- When the access control function is enabled, Mac OS X might not be able to scan. Contact your system administrator.
- If you are scanning with the ADF, check that the document cover and ADF cover are closed.
- Connect the interface cable securely to the printer and the computer.
- If you are using a USB hub, connect the printer directly to the computer.
- When using the printer on a network, make sure the printer is connected to the network properly. You can check the connection status from the network icon on the printer window and by printing a network status sheet. If the printer is not connected to the network, see the *Network Guide*.

Solving Problems

- Make sure you select the correct printer (scanner) if a scanner list is displayed when you start EPSON Scan.
- If you are using any TWAIN-compliant applications, select the printer (scanner) you are using.
- In Windows, make sure the printer (scanner) is displayed in **Scanner and Camera**. The printer (scanner) should be displayed as "EPSON XXXXX (printer name)". If the printer (scanner) is not displayed, uninstall and then re-install EPSON Scan. See the following to access **Scanner and Camera**.
 - Windows 8.1/Windows 8/Windows Server 2012 R2/Windows Server 2012
Select **Desktop > Settings > Control Panel**, enter "Scanner and Camera" in the search charm, click **Show Scanner and Camera**, and then check if the printer is displayed.
 - Windows 7/Windows Server 2008 R2
Click the start button and select **Control Panel**, enter "Scanner and Camera" in the search charm, click **View scanners and cameras**, and then check if the printer is displayed.
 - Windows Vista/Windows Server 2008
Click the start button, select **Control Panel > Hardware and Sound > Scanners and Cameras**, and then check if the printer is displayed.
 - Windows XP/Windows Server 2003 R2/Windows Server 2003
Click the start button, select **Control Panel > Printers and Other Hardware > Scanner and Cameras**, and then check if the printer is displayed.
- If you cannot scan using any TWAIN-compliant applications, uninstall and then reinstall the TWAIN-compliant application.
- For Mac OS X with an Intel processor, if other Epson scanner drivers except for EPSON Scan, such as Rosetta or PPC are installed, uninstall them and EPSON Scan, and then reinstall EPSON Scan.

Related Information

- ➔ [“Uninstalling Applications” on page 130](#)
- ➔ [“Installing Applications” on page 131](#)

Scanned Image Problems

Scan Quality Is Poor

- Clean the scanner glass.
- Clean the ADF.
- Do not press too hard on the original or the document cover when you are placing the originals on the scanner glass. Uneven colors, smears, or dots may appear when the original or the document cover are pressed too hard.
- Remove dust from the original.
- Make the appropriate document type settings on the control panel.
- Scan at a higher resolution.
- Adjust the image in EPSON Scan, and then scan. See the EPSON Scan help for details.

Related Information

- ➔ [“Cleaning the Scanner Glass” on page 122](#)
- ➔ [“Cleaning the ADF” on page 119](#)

Solving Problems

➔ [“Scan Mode” on page 23](#)

Characters Are Blurred

- In **Office Mode** in EPSON Scan, select **Image Option** on the **Image Adjustment** tab, and then select **Text Enhancement**.
- In **Professional Mode** in EPSON Scan, select **Document** as the **Auto Exposure Type** in the **Original** settings.
- Adjust the threshold settings in EPSON Scan.
 - Office Mode**
Select **Black & White** as the **Image Type** on the **Main Settings** tab, and then adjust the threshold setting on the **Image Adjustment** tab.
 - Professional Mode**
Select **Black & White** as the **Image Type** setting, and then adjust the threshold setting.
- Scan at a higher resolution.

An Image of the Reverse Side of the Original Appears in the Scanned Image

- For a thin original, place the original on the scanner glass and then place a piece of black paper over it.
- Make the appropriate document type settings on the control panel or in EPSON Scan.
- In **Office Mode** in EPSON Scan, select **Image Option** on the **Image Adjustment** tab, and then select **Text Enhancement**.

Related Information

➔ [“Scan Mode” on page 23](#)

Moiré (Cross-Hatch) Patterns Appear in the Scanned Image

- Place the original at a slightly different angle.
- Select **Descreening** in EPSON Scan.
- Change the resolution setting on the control panel or in EPSON Scan.

Related Information

➔ [“Scan Mode” on page 23](#)

Scanning Area or Direction Is Not Correct

- When placing the originals on the scanner glass, align the corner of the original with the corner indicated by a symbol on the frame of the scanner glass. If the edges of the scanned image are cropped off, move the original slightly away from the corner.
- Clean the scanner glass and the document cover. If there is dust or stains on the glass, the scanning area may extend to include the dust or stains, resulting in the wrong scanning position or small images.

Solving Problems

- ❑ When you place multiple originals on the scanner glass to scan them separately, but they are scanned onto a single file, place the originals at least 20 mm (0.8 inch) apart. If the problem continues, place one original at a time.
- ❑ When scanning from the control panel, set the scan area correctly.
- ❑ When scanning using the thumbnail preview in EPSON Scan, move the original 4.5 mm (0.18 inch) away from the edges of the scanner glass. In other situations, move the original 1.5 mm (0.06 inch) away from the edges of the scanner glass.
- ❑ When using the thumbnail preview for a large original in **Professional Mode**, the scanning area may not be correct. When previewing in EPSON Scan, create marquees of the area you want to scan on the **Normal** tab in the **Preview** window.
- ❑ Click **Configuration** in EPSON Scan, and then clear **Auto Photo Orientation** on the **Preview** tab.
- ❑ If **Auto Photo Orientation** in EPSON Scan does not work as intended, see the EPSON Scan help.
- ❑ When scanning with EPSON Scan the available scanning area may be restricted if the resolution setting is too high. Lower the resolution or adjust the scanning area in the **Preview** window.

Related Information

- ➔ [“Placing Originals” on page 47](#)
- ➔ [“Cleaning the Scanner Glass” on page 122](#)
- ➔ [“Scan Mode” on page 23](#)

The Scanned Image Problem Could Not be Cleared

If you have tried all of the solutions and have not solved the problem, click **Configuration** in the EPSON Scan window, and then click **Reset All** on the **Other** tab to initialize the EPSON Scan settings. If initialization does not solve the problem uninstall and re-install EPSON Scan.

Related Information

- ➔ [“Uninstalling Applications” on page 130](#)
- ➔ [“Installing Applications” on page 131](#)

Other Scanning Problems

Thumbnail Preview Does Not Work Properly

See the EPSON Scan help.

Scanning Is Too Slow

- ❑ Lower the resolution.
- ❑ Click **Configuration** in EPSON Scan, and then disable **Quiet Mode** on the **Other** tab.

Related Information

- ➔ [“Scan Mode” on page 23](#)

Cannot Send the Scanned Image by Email

Make sure you have configured the email server settings.

Related Information

➔ [“Configuring an Email Server” on page 185](#)

Scanning Stops when Scanning to PDF/Multi-TIFF

- When scanning using EPSON Scan, you can scan up to 999 pages in PDF format and up to 200 pages in Multi-TIFF format. When scanning using the control panel, you can scan up to 50 pages in PDF format and in Multi-TIFF format.
- When scanning large volumes, we recommend scanning in grayscale.
- Increase the free space on the computer's hard disk. Scanning may stop if there is not enough free space.
- Try scanning at a lower resolution. Scanning stops if the total data size reaches the limit.

Related Information



➔ [“Scan Mode” on page 23](#)

Problems when Sending and Receiving Faxes

Cannot Send or Receive Faxes

- Use **Check Fax Connection** on the control panel to run the automatic fax connection check. Try the solutions printed on the report.
- Check the error code displayed for the failed fax job, and try the solutions described in the error code list.
- Check the **Line Type** setting. Setting to **PBX** may solve the problem. If your phone system requires an external access code to get an outside line, register the access code to the printer, and enter # (hash) at the beginning of a fax number when sending.
- If a communication error occurs, change the **Fax Speed** setting to **Slow(9,600bps)** on the control panel.
- Check that the telephone wall jack works by connecting a phone to it and testing it. If you cannot make or receive calls, contact your telecommunication company.
- To connect to a DSL phone line, you need to use a DSL modem equipped with a built-in DSL filter, or install a separate DSL filter to the line. Contact your DSL provider.
- If you are connecting to a DSL phone line, connect the printer directly to a telephone wall jack to see if the printer can send a fax. If it works, the problem may be caused by the DSL filter. Contact your DSL provider.
- Enable the **ECM** setting on the control panel. Color faxes cannot be sent or received when **ECM** is off.
- To send or receive faxes using the computer, make sure that the printer is connected using a USB cable or a network, and that the PC-FAX Driver have been installed on the computer. The PC-FAX Driver is installed together with FAX Utility.

Solving Problems

- ❑ In Windows, make sure the printer (fax) is displayed in **Devices and Printers**, **Printer**, or **Printers and Other Hardware**. The printer (fax) is displayed as "EPSON XXXXX (FAX)". If the printer (fax) is not displayed, uninstall and then re-install the FAX Utility. See the following to access **Devices and Printers**, **Printer**, or **Printers and Other Hardware**.
 - ❑ Windows 8.1/Windows 8
Select **Desktop > Settings > Control Panel > View devices and printers in Hardware and Sound or Hardware**.
 - ❑ Windows 7
Click the start button, and select **Control Panel > View devices and printers in Hardware and Sound or Hardware**.
 - ❑ Windows Vista
Click the start button, and select **Control Panel > Printers in Hardware and Sound**.
 - ❑ Windows XP
Click the start button, and select **Settings > Control Panel > Printers and Other Hardware > Printers and Faxes**.
- ❑ In Mac OS X, check the following.
 - ❑ Select **System Preferences** from the  menu > **Printers & Scanners** (or **Print & Scan**, **Print & Fax**), and then make sure the printer (fax) is displayed. The printer (fax) is displayed as "FAX XXXX (USB)" or "FAX XXXX (IP)". If the printer (fax) is not displayed, click [+] and then register the printer (fax).
 - ❑ Select **System Preferences** from the  menu > **Printers & Scanners** (or **Print & Scan**, **Print & Fax**), and then double-click the printer (fax). If the printer is paused, click **Resume** (or **Resume Printer**).

Related Information

- ➔ ["Fax Settings" on page 32](#)
- ➔ ["Error Code on the Status Menu" on page 137](#)
- ➔ ["Making Settings for a PBX Phone System" on page 93](#)
- ➔ ["Connecting the Printer to a Phone Line" on page 89](#)
- ➔ ["Uninstalling Applications" on page 130](#)
- ➔ ["Installing Applications" on page 131](#)

Cannot Send Faxes

- ❑ If the user restriction feature has been enabled, a user name and password are required to operate the printer. Contact your administrator if you do not know the password.
- ❑ If the user restriction feature has been enabled, and you send a fax from a computer, user authentication is performed using the user name and password set in the printer driver. When you cannot send a fax due to an authentication error, contact your administrator.
- ❑ Set up the header information for outgoing faxes on the control panel. Some fax machines automatically reject incoming faxes that do not include header information.
- ❑ If you have blocked your caller ID, unblock it. Some phones or fax machines automatically reject anonymous calls.
- ❑ Ask the recipient if the fax number is correct and the recipient's fax machine is ready to receive a fax.

Solving Problems

Related Information

- ➔ [“Fax Settings” on page 32](#)
- ➔ [“Cannot Send or Receive Faxes” on page 159](#)

Cannot Send Faxes to a Specific Recipient

Check the following if you cannot send faxes to a specific recipient due to an error.

- If the recipient machine does not pick up your call within 50 seconds after the printer has finished dialing, the call ends with an error. Dial using the **On Hook** feature or using a connected telephone to check how long it takes before you hear a fax tone. If it takes more than 50 seconds, add pauses after the fax number to send the fax. Press  to enter the pause. A hyphen is entered as the pause mark. One pause is about three seconds. Add multiple pauses as needed.
- If you have selected the recipient from the contacts list, verify that the registered information is correct. If the information is correct, select the recipient from the contacts list, press **Edit** and change **Fax Speed** to **Slow(9,600bps)**.

Related Information

- ➔ [“Sending Faxes After Confirming the Recipient's Status” on page 96](#)
- ➔ [“Sending Faxes Dialing from the External Phone Device” on page 96](#)
- ➔ [“Managing Contacts” on page 51](#)
- ➔ [“Cannot Send or Receive Faxes” on page 159](#)

Cannot Send Faxes at a Specified Time

Set the date and the time correctly on the control panel.

Related Information

- ➔ [“Sending Faxes at a Specified Time \(Send Fax Later\)” on page 97](#)
- ➔ [“System Administration” on page 29](#)

Cannot Receive Faxes

- If you have subscribed to a call forwarding service, the printer may not be able to receive faxes. Contact the service provider.
- If you have not connected a telephone to the printer, set the **Receive Mode** setting to **Auto** on the control panel.

Related Information

- ➔ [“Fax Settings” on page 32](#)
- ➔ [“Cannot Send or Receive Faxes” on page 159](#)

Memory Full Error Occurs

- If the printer has been set to save received faxes in the inbox, delete faxes you have already read from the inbox.

Solving Problems

- ❑ If the printer has been set to save received faxes on a computer, turn on the computer that is set to save the faxes. Once the faxes are saved in the computer, they are deleted from the printer's memory.
- ❑ If the printer has been set to save received faxes on a memory device, connect the device, in which you have created a folder to save faxes, to the printer. Once the faxes are saved in the device, they are deleted from the printer's memory. Make sure that the device has enough available memory and is not write protected.
- ❑ Even though the memory is full, you can send a monochrome fax by using the **Direct Send** feature. Or divide your originals into two or more to send them in several batches.
- ❑ If the printer cannot print a received fax due to a printer error, such as a paper jam, the memory full error may occur. Clear the printer problem, and then contact the sender and ask them to send the fax again.

Related Information

- ➔ [“Saving Received Faxes” on page 102](#)
- ➔ [“Checking the Received Faxes on the LCD Screen” on page 103](#)
- ➔ [“Fax Mode” on page 25](#)
- ➔ [“Removing Jammed Paper” on page 142](#)

Sent Fax Quality Is Poor

- ❑ Clean the scanner glass.
- ❑ Clean the ADF.
- ❑ Change the **Resolution** setting on the control panel. If your originals contain both text and photos, select **Photo**.
- ❑ Change the **Density** setting on the control panel.
- ❑ If you are not sure about the capabilities of the recipient fax machine, enable the Direct Send feature or select **Fine** as the **Resolution** setting.
If you select **Super Fine** or **Ultra Fine** for a monochrome fax, and send the fax without using the **Direct Send** feature, the printer may automatically lower the resolution.
- ❑ Enable the **ECM** setting on the control panel.

Related Information

- ➔ [“Fax Mode” on page 25](#)
- ➔ [“Fax Settings” on page 32](#)
- ➔ [“Cleaning the Scanner Glass” on page 122](#)
- ➔ [“Cleaning the ADF” on page 119](#)

Faxes Are Sent at the Wrong Size

- ❑ When sending a fax using the scanner glass, place the original correctly aligning its corner with the origin mark. Select your original size on the control panel.
- ❑ Clean the scanner glass and the document cover. If there is dust or stains on the glass, the scanning area may extend to include the dust or stains, resulting in the wrong scanning position or small images.

Related Information

- ➔ [“Fax Mode” on page 25](#)

Solving Problems

- ➔ [“Placing Originals” on page 47](#)
- ➔ [“Cleaning the Scanner Glass” on page 122](#)

Received Fax Quality Is Poor

- Enable the **ECM** setting on the control panel.
- Contact the sender and ask them to send using a higher quality mode.
- Reprint the received fax. Select **Job History** from **Status Menu** to reprint the fax.

Related Information

- ➔ [“Fax Settings” on page 32](#)
- ➔ [“Checking the Fax Job History” on page 106](#)

Received Faxes Are Not Printed

- If an error has occurred on the printer, such as a paper jam, the printer cannot print received faxes. Check the printer.
- If the printer has been set to save received faxes in the inbox, the received faxes are not automatically printed. Check the **Fax Output** setting.

Related Information

- ➔ [“Checking the Printer Status” on page 136](#)
- ➔ [“Removing Jammed Paper” on page 142](#)
- ➔ [“Saving Received Faxes” on page 102](#)

Other Faxing Problems

Cannot Make Calls on the Connected Telephone

Connect the telephone to the **EXT.** port on the printer, and pick up the receiver. If you cannot hear a dial tone through the receiver, connect the phone cable correctly.

Related Information

- ➔ [“Connecting Your Phone Device to the Printer” on page 91](#)

Answering Machine Cannot Answer Voice Calls

On the control panel, set the printer's **Rings to Answer** setting to a number higher than the number of rings for your answering machine.

Related Information

- ➔ [“Fax Settings” on page 32](#)

Solving Problems

➔ [“Settings for the Answering Machine” on page 100](#)

Sender's Fax Number Not Displayed on Received Faxes or the Number Is Wrong

The sender may not have set the fax header information or may have set it incorrectly. Contact the sender.

Cannot Forward Received Documents to Email Addresses

- The **Email Server** settings of the printer may not have been configured. Configure the email server settings.
- Wrong email address may have been registered to the contacts list. Make sure the address in the contacts list is correct.

Related Information

➔ [“Using an Email Server” on page 184](#)

➔ [“Managing Contacts” on page 51](#)

Other Problems

Slight Electric Shock when Touching the Printer

If many peripherals are connected to the computer, you may feel a slight electric shock when touching the printer. Install a ground wire to the computer that is connected to the printer.

Operation Sounds Are Loud

If operations sounds are too loud, enable quiet mode. However, this may slow down printer operations.

- Windows printer driver
 - Select **On** as the **Quiet Mode** setting on the **Main** tab.
- Mac OS X printer driver
 - Select **System Preferences** from the  menu > **Printers & Scanners** (or **Print & Scan, Print & Fax**), and then select the printer. Click **Options & Supplies** > **Options** (or **Driver**). Select **On** as the **Quiet Mode** setting.
- EPSON Scan
 - Click **Configuration**, and then set **Quiet Mode** on the **Other** tab.

The Date and Time Are Incorrect

Set the date and the time correctly on the control panel. After a power failure caused by a lightning strike or if the power is left off for a long time, the clock may show the wrong time.

Related Information

➔ [“System Administration” on page 29](#)

Memory Device Is not Recognized

Enable the memory card in the **Memory Device Interface** settings on the control panel.

Related Information

➔ [“Printer Settings” on page 31](#)

Cannot Save Data to a Memory Device

- Insert the memory device in the printer, and then select **Fax Output > Other Settings > Create Folder to Save** to create a folder to save documents in the memory device. You cannot use a memory device that does not have a folder.
- Check that the memory device is not write protected.
- Check that the memory device has enough available memory. If the available memory is low, data cannot be saved.

Related Information

➔ [“Saving Received Faxes” on page 102](#)

➔ [“Fax Settings” on page 32](#)

Forgot Your Password

If you forget the administrator's password, contact Epson support.

Related Information

➔ [“Contacting Epson Support” on page 187](#)

Application Is Blocked by a Firewall (for Windows Only)

Add the application to the Windows Firewall allowed program in security settings on the **Control Panel**.

Appendix

Technical Specifications

Printer Specifications

Print Head Nozzle Placement		Black ink nozzles: 400 × 4 rows
Weight of Paper	Plain Paper	64 to 90 g/m ² (17 to 24 lb)
	Thick Paper	91 to 256 g/m ² (25 to 68 lb)
	Envelope	Envelope #10, DL, C6: 75 to 90 g/m ² (20 to 24 lb) Envelope C4: 80 to 100 g/m ² (21 to 26 lb)

Printable Area

Print quality may decline in the shaded areas due to the printer's mechanism.

Single sheets

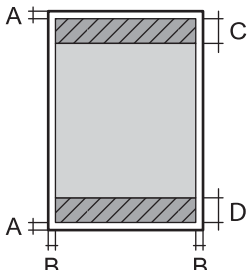
	A	3.0 mm (0.12 in.)
	B	3.0 mm (0.12 in.)
	C	45.0 mm (1.77 in.)
	D	50.0 mm (1.97 in.)

Envelopes

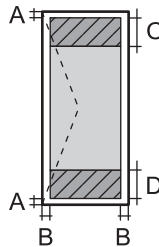
	A	3.0 mm (0.12 in.)
	B	Except for C4: 5.0 mm (0.20 in.) C4: 9.5 mm (0.37 in.)
	C	18.0 mm (0.71 in.)
	D	45.0 mm (1.77 in.)

Scanner Specifications

Scanner Type	Flatbed
--------------	---------

Appendix

Photoelectric Device	CIS
Effective Pixels	10200 × 14040 pixels at 1200 dpi
Maximum Document Size	216 × 297 mm (8.5 × 11.7 in.) A4, Letter
Scanning Resolution	1200 dpi (main scan) 2400 dpi (sub scan)
Output Resolution	50 to 4800, 7200, 9600 dpi (50 to 4800 dpi in 1 dpi increments.)
Color Depth	Color <input type="checkbox"/> 16 bits per pixel per color internal <input type="checkbox"/> 8 bits per pixel per color external Black and white <input type="checkbox"/> 16 bits per pixel per color internal <input type="checkbox"/> 1 or 8 bits per pixel per color external
Light Source	LED

Interface Specifications

For Computer	Hi-Speed USB
For External USB Device	Hi-Speed USB

Fax Specifications

Fax Type	ITU-T Super Group 3, Black-and-white and color fax capability (Black-and-white only for receiving faxes)
Supported Lines	Standard analogue telephone lines, PBX (Private Branch Exchange) telephone systems
Speed	Up to 33.6 kbps
Resolution	Monochrome <input type="checkbox"/> Standard: 8 pel/mm × 3.85 line/mm (203 pel/in. × 98 line/in.) <input type="checkbox"/> Fine: 8 pel/mm × 7.7 line/mm (203 pel/in. × 196 line/in.) <input type="checkbox"/> Super Fine: 8 pel/mm × 15.4 line/mm (203 pel/in. × 392 line/in.) <input type="checkbox"/> Ultra Fine: 16 pel/mm × 15.4 line/mm (406 pel/in. × 392 line/in.) <input type="checkbox"/> Photo: 8 pel/mm × 7.7 line/mm (203 pel/in. × 196 line/in.) Color <input type="checkbox"/> Fine: 200 × 200 dpi <input type="checkbox"/> Photo: 200 × 200 dpi
Page Memory	Up to 550 pages (when received ITU-T No.1 chart in monochrome draft mode)

Appendix

Redial*	2 times (with 1 minute intervals)
Interface	RJ-11 Phone Line, RJ-11 Telephone set connection

* The specifications may differ by country or region.

Wi-Fi Specifications

Standards	IEEE802.11b/g/n
Frequency Range	2.4 GHz
Coordination Modes	Infrastructure, Ad hoc* ¹ , Wi-Fi Direct* ² * ³
Wireless Securities	WEP (64/128bit), WPA2-PSK (AES)* ⁴ , WPA2-Enterprise

*¹ Not supported for IEEE 802.11n.

*² Not supported for IEEE 802.11b.

*³ Simple AP mode is compatible with Ethernet connection.

*⁴ Complies with WPA2 standards with support for WPA/WPA2 Personal.

Ethernet Specifications

Standards	IEEE802.3i (10BASE-T)* ¹ IEEE802.3u (100BASE-TX) IEEE802.3ab (1000BASE-T)* ¹ IEEE802.3az (Energy Efficient Ethernet)* ²
Communication Mode	Auto, 10Mbps Full duplex, 10Mbps Half duplex, 100Mbps Full duplex, 100Mbps Half duplex
Connector	RJ-45

*¹ Use a category 5e or higher STP (Shielded twisted pair) cable to prevent risk of radio interference.

*² The connected device should comply with IEEE802.3az standards.

Security Protocol

IEEE802.1X*	
IPsec/IP Filtering	
SSL/TLS	HTTPS Server/Client
	IPPS
SNMPv3	

* You need to use a device for connection that complies with IEEE802.1X.

Appendix

Supported Third Party Services

AirPrint	Print	iOS 5 or later/Mac OS X v10.7.x or later
Google Cloud Print		

External USB Device Specifications

Devices	Maximum Capacities
MO Drive*	1.3 GB
Hard Disk Drive* USB Flash Drive	2 TB (formatted in FAT, FAT32, or exFAT.)

* We do not recommend using external USB devices that are powered by USB. Use only external USB devices with independent AC power sources.

You cannot use the following devices:

- A device that requires a dedicated driver
- A device with security settings (password, encryption, and so on)
- A device with a built-in USB hub

Epson cannot guarantee all operations of externally connected devices.

Supported Data Specifications

File Format	JPEG with the Exif Version 2.3 standard taken by digital cameras DCF* ¹ version 1.0 or 2.0* ² compliant TIFF 6.0 compliant images as below <input type="checkbox"/> RGB full color images (not compressed) <input type="checkbox"/> Binary images (not compressed or CCITT encoded) PDF Version 1.7 compliant data file
Image Size	Horizontal: 80 to 10200 pixels Vertical: 80 to 10200 pixels
File Size	Up to 2 GB
Maximum Number of Files	JPEG: 9990* ³ TIFF: 999 PDF: 999

*1 Design rule for Camera File system.

*2 Photo data stored on digital cameras with a built-in memory is not supported.

*3 Up to 999 files can be displayed at a time. (If the number of files exceeds 999, the files are displayed in groups.)

Appendix

Note:

"?" is displayed on the LCD screen when the printer cannot recognize the image file. In this situation, if you select a multiple image layout, blank sections will be printed.

Dimensions

Dimensions	<p>Storage</p> <ul style="list-style-type: none"> <input type="checkbox"/> Width: 461 mm (18.1 in.) <input type="checkbox"/> Depth: 422 mm (16.6 in.) <input type="checkbox"/> Height: 342 mm (13.5 in.) <p>Printing</p> <ul style="list-style-type: none"> <input type="checkbox"/> Width: 461 mm (18.1 in.) <input type="checkbox"/> Depth: 655 mm (25.8 in.) <input type="checkbox"/> Height: 383 mm (15.1 in.)
Weight*	Approx. 14.1 kg (31.1 lb)

* Without the ink cartridges and the power cord.

Electrical Specifications

Model	100 to 240 V Model	220 to 240 V Model
Rated Frequency Range	50 to 60 Hz	50 to 60 Hz
Rated Current	0.8 to 0.4 A	0.4 A
Power Consumption (with USB Connection)	<p>Standalone copying: Approx. 22 W (ISO/IEC24712)</p> <p>Ready mode: Approx. 8.9 W</p> <p>Sleep mode: Approx. 2.6 W</p> <p>Power off: Approx. 0.4 W</p>	<p>Standalone copying: Approx. 22 W (ISO/IEC24712)</p> <p>Ready mode: Approx. 9.6 W</p> <p>Sleep mode: Approx. 3.0 W</p> <p>Power off: Approx. 0.4 W</p>

Note:

- Check the label on the printer for its voltage.
- For European users, see the following Website for details on power consumption.
<http://www.epson.eu/energy-consumption>
- For users in Belgium, power consumption when copying may vary.
Check <http://www.epson.be> for the latest specifications.

Appendix

Environmental Specifications

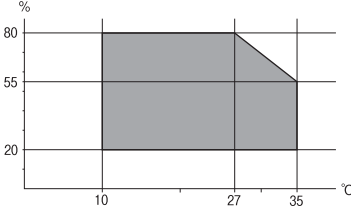
Operation	<p>Use the printer within the range shown in the following graph.</p>  <p>Temperature: 10 to 35°C (50 to 95°F) Humidity: 20 to 80% RH (without condensation)</p>
Storage	<p>Temperature: -20 to 40°C (-4 to 104°F)* Humidity: 5 to 85% RH (without condensation)</p>

* You can store for one month at 40°C (104°F).

Environmental Specifications for Ink Cartridges

Storage Temperature	-20 to 40 °C (-4 to 104 °F)*
Freezing Temperature	<p>-10 °C (14 °F) Ink thaws and is usable after approximately 3 hours at 25 °C (77 °F).</p>

* You can store for one month at 40 °C (104 °F).

System Requirements

- Windows 8.1 (32-bit, 64-bit)/Windows 8 (32-bit, 64-bit)/Windows 7 (32-bit, 64-bit)/Windows Vista (32-bit, 64-bit)/Windows XP Professional x64 Edition/Windows XP (32-bit)/Windows Server 2012 R2/Windows Server 2012/Windows Server 2008 R2/Windows Server 2008 (32-bit, 64-bit)/Windows Server 2003 R2 (32-bit, 64-bit)/Windows Server 2003 (32-bit, 64-bit)
- Mac OS X v10.9.x/Mac OS X v10.8.x/Mac OS X v10.7.x/Mac OS X v10.6.8

Note:

- Mac OS X may not support some applications and features.
- The UNIX File System (UFS) for Mac OS X is not supported.

Font Information

Available Fonts for PostScript

Font Name	Family	HP Equivalent
Nimbus Mono	Medium, Bold, Italic, Bold Italic	Courier

Appendix

Font Name	Family	HP Equivalent
Letter Gothic	Medium, Bold, Italic	Letter Gothic
Nimbus Mono PS	Regular, Bold, Oblique, Bold Oblique	CourierPS
Nimbus Roman No4	Medium, Bold, Italic, Bold Italic	CG Times
URW Classico	Medium, Bold, Italic, Bold Italic	CG Omega
URW Coronet	-	Coronet
URW Clarendon Condensed	-	Clarendon Condensed
URW Classic Sans	Medium, Bold, Italic, Bold Italic	Univers
URW Classic Sans Condensed	Medium, Bold, Italic, Bold Italic	Univers Condensed
Antique Olive	Medium, Bold, Italic	Antique Olive
Garamond	Antiqua, Halbfett, Kursiv, Kursiv Halbfett	Garamond
Mauritius	-	Marigold
Algiers	Medium, Extra Bold	Albertus
NimbusSansNo2	Medium, Bold, Italic, Bold Italic	Arial
Nimbus Roman No9	Medium, Bold, Italic, Bold Italic	Times New
Nimbus Sans	Medium, Bold, Oblique, Bold Oblique	Helvetica
Nimbus Sans Narrow	Medium, Bold, Oblique, Bold Oblique	Helvetica Narrow
Palladio	Roman, Bold, Italic, Bold Italic	Palatino
URW Gothic	Book, Demi, Book Oblique, Demi Oblique	ITC Avant Garde
URW Bookman	Light, Demi, Light Italic, Demi Italic	ITC Bookman
URW Century Schoolbook	Roman, Bold, Italic, Bold Italic	New Century Schoolbook
Nimbus Roman	Medium, Bold, Italic, Bold Italic	Times
URW Chancery Medium Italic	-	ITC Zapf Chancery Italic
Symbol	-	Symbol
URW Dingbats	-	Wingdings
Dingbats	-	ITC Zapf Dingbats
Standard Symbol	-	SymbolPS

Appendix

Available Fonts for PCL

Scalable Font

Font Name	Family	HP Equivalent	Symbol Set
Nimbus Mono	Medium, Bold, Italic, Bold Italic	Courier	1
Letter Gothic	Medium, Bold, Italic	Letter Gothic	1
Nimbus Mono PS	Regular, Bold, Oblique, Bold Oblique	CourierPS	3
Nimbus Roman No4	Medium, Bold, Italic, Bold Italic	CG Times	2
URW Classico	Medium, Bold, Italic, Bold Italic	CG Omega	3
URW Coronet	-	Coronet	3
URW Clarendon Condensed	-	Clarendon Condensed	3
URW Classic Sans	Medium, Bold, Italic, Bold Italic	Univers	2
URW Classic Sans Condensed	Medium, Bold, Italic, Bold Italic	Univers Condensed	3
Antique Olive	Medium, Bold, Italic	Antique Olive	3
Garamond	Antiqua, Halbfett, Kursiv, Kursiv Halbfett	Garamond	3
Mauritius	-	Marigold	3
Algiers	Medium, Extra Bold	Albertus	3
NimbusSansNo2	Medium, Bold, Italic, Bold Italic	Arial	3
Nimbus Roman No9	Medium, Bold, Italic, Bold Italic	Times New	3
Nimbus Sans	Medium, Bold, Oblique, Bold Oblique	Helvetica	3
Nimbus Sans Narrow	Medium, Bold, Oblique, Bold Oblique	Helvetica Narrow	3
Palladio	Roman, Bold, Italic, Bold Italic	Palatino	3
URW Gothic	Book, Demi, Book Oblique, Demi Oblique	ITC Avant Garde	3
URW Bookman	Light, Demi, Light Italic, Demi Italic	ITC Bookman	3
URW Century Schoolbook	Roman, Bold, Italic, Bold Italic	New Century Schoolbook	3
Nimbus Roman	Medium, Bold, Italic, Bold Italic	Times	3
URW Chancery Medium Italic	-	ITC Zapf Chancery Italic	3
Symbol	-	Symbol	4
URW Dingbats	-	Wingdings	5
Dingbats	-	ITC Zapf Dingbats	6
Standard Symbol	-	SymbolPS	4

Appendix

Font Name	Family	HP Equivalent	Symbol Set
URW David	Medium, Bold	HP David	7
URW Narkis	Medium, Bold	HP Narkis Tam	7
URW Miryam	Medium, Bold, Italic	HP Miryam	7
URW Koufi	Medium, Bold	Koufi	8
URW Naskh	Medium, Bold	Naskh	8
URW Ryadh	Medium, Bold	Ryadh	8

Bitmap Font

Font Name	Symbol Set
Line Printer	9

OCR/Barcode Bitmap Font (for PCL5 only)

Font Name	Family	Symbol Set
OCR A	-	10
OCR B	-	11
Code39	9.37cpi, 4.68cpi	12
EAN/UPC	Medium, Bold	13

Note:

Depending on the print density, or on the quality or color of the paper, OCR A, OCR B, Code39, and EAN/UPC fonts may not be readable. Print a sample and make sure the fonts can be read before printing large quantities.

Related Information

- ➔ [“List of Symbol Sets for PCL 5” on page 175](#)
- ➔ [“The List of the Symbol Sets for PCL 6” on page 177](#)

List of Symbol Sets

Your printer can access a variety of symbol sets. Many of these symbol sets differ only in the international characters specific to each language.

When you are considering which font to use, you should also consider which symbol set to combine with the font.

Note:

Since most software handles fonts and symbols automatically, you will probably never need to adjust the printer's settings. However, if you are writing your own printer control programs, or if you are using older software that cannot control fonts, refer to the following sections for symbol set details.

Appendix

List of Symbol Sets for PCL 5

Symbol Set Name	Attribute	Font Classification												
		1	2	3	4	5	6	7	8	9	10	11	12	13
ISO 60: Danish/ Norwegian	0D	✓	✓	✓	-	-	-	-	-	-	-	-	-	-
Roman Extension	0E	-	-	-	-	-	-	-	-	✓	-	-	-	-
ISO 15: Italian	0I	✓	✓	✓	-	-	-	-	-	-	-	-	-	-
ISO 8859/1 Latin 1	0N	✓	✓	✓	-	-	-	-	-	✓	-	-	-	-
ISO 11: Swedish	0S	✓	✓	✓	-	-	-	-	-	-	-	-	-	-
ISO 6: ASCII	0U	✓	✓	✓	-	-	-	✓	✓	-	-	-	-	-
ISO 4: United Kingdom	1E	✓	✓	✓	-	-	-	-	-	-	-	-	-	-
ISO 69: French	1F	✓	✓	✓	-	-	-	-	-	-	-	-	-	-
ISO 29: German	1G	✓	✓	✓	-	-	-	-	-	-	-	-	-	-
Legal	1U	✓	✓	✓	-	-	-	-	-	✓	-	-	-	-
ISO 8859/2 Latin 2	2N	✓	✓	✓	-	-	-	-	-	✓	-	-	-	-
ISO 17: Spanish	2S	✓	✓	✓	-	-	-	-	-	-	-	-	-	-
ISO 8859/4 Latin 4	4N	✓	✓	✓	-	-	-	-	-	-	-	-	-	-
Roman-9	4U	✓	✓	✓	-	-	-	-	-	-	-	-	-	-
PS Math	5M	✓	✓	✓	-	-	-	✓	✓	-	-	-	-	-
ISO 8859/9 Latin 5	5N	✓	✓	✓	-	-	-	-	-	✓	-	-	-	-
Windows 3.1 Latin 5	5T	✓	✓	✓	-	-	-	-	-	-	-	-	-	-
Microsoft Publishing	6J	✓	✓	✓	-	-	-	-	-	-	-	-	-	-
Ventura Math	6M	✓	✓	✓	-	-	-	-	-	-	-	-	-	-
ISO 8859/10 Latin 6	6N	✓	✓	✓	-	-	-	-	-	✓	-	-	-	-
DeskTop	7J	✓	✓	✓	-	-	-	-	-	-	-	-	-	-
Math-8	8M	✓	✓	✓	-	-	-	✓	✓	-	-	-	-	-
Roman-8	8U	✓	✓	✓	-	-	-	-	-	✓	-	-	-	-

Appendix

Symbol Set Name	Attribute	Font Classification												
		1	2	3	4	5	6	7	8	9	10	11	12	13
Windows 3.1 Latin 2	9E	✓	✓	✓	-	-	-	-	-	-	-	-	-	-
Pc1004	9J	✓	✓	✓	-	-	-	-	-	-	-	-	-	-
ISO 8859/15 Latin 9	9N	✓	✓	✓	-	-	-	-	-	✓	-	-	-	-
PC-8 Turkish	9T	✓	✓	✓	-	-	-	-	-	-	-	-	-	-
Windows 3.0 Latin 1	9U	✓	✓	✓	-	-	-	-	-	-	-	-	-	-
PS Text	10J	✓	✓	✓	-	-	-	-	-	-	-	-	-	-
PC-8, Code Page 437	10U	✓	✓	✓	-	-	-	-	-	✓	-	-	-	-
PC-8, D/N, Danish/Norwegian	11U	✓	✓	✓	-	-	-	-	-	✓	-	-	-	-
MC Text	12J	✓	✓	✓	-	-	-	-	-	-	-	-	-	-
PC-850, Multilingual	12U	✓	✓	✓	-	-	-	-	-	✓	-	-	-	-
Ventura International	13J	✓	✓	✓	-	-	-	-	-	-	-	-	-	-
PcEur858	13U	✓	✓	✓	-	-	-	-	-	-	-	-	-	-
Ventura US	14J	✓	✓	✓	-	-	-	-	-	-	-	-	-	-
Pi Font	15U	✓	✓	✓	-	-	-	-	-	-	-	-	-	-
PC852, Latin 2	17U	✓	✓	✓	-	-	-	-	-	-	-	-	-	-
Unicode 3.0	18N	✓	✓	✓	-	-	-	✓	✓	-	-	-	-	-
Windows Baltic	19L	✓	✓	✓	-	-	-	-	-	-	-	-	-	-
Windows 3.1 Latin/Arabic	19U	✓	✓	✓	-	-	-	-	-	-	-	-	-	-
PC-755	26U	✓	✓	✓	-	-	-	-	-	-	-	-	-	-
PC-866, Cyrillic	3R	✓	✓	-	-	-	-	-	-	-	-	-	-	-
Greek8	8G	✓	✓	-	-	-	-	-	-	-	-	-	-	-
Windows Greek	9G	✓	✓	-	-	-	-	-	-	-	-	-	-	-
Windows Cyrillic	9R	✓	✓	-	-	-	-	-	-	-	-	-	-	-
PC-851, Greek	10G	✓	✓	-	-	-	-	-	-	-	-	-	-	-

Appendix

Symbol Set Name	Attribute	Font Classification												
		1	2	3	4	5	6	7	8	9	10	11	12	13
ISO 8859/5 Cyrillic	10N	✓	✓	-	-	-	-	-	-	✓	-	-	-	-
PC-8, Greek	12G	✓	✓	-	-	-	-	-	-	-	-	-	-	-
ISO 8859/7 Greek	12N	✓	✓	-	-	-	-	-	-	-	-	-	-	-
PC-866 UKR	14R	✓	✓	-	-	-	-	-	-	-	-	-	-	-
Hebrew7	0H	✓	-	-	-	-	-	✓	-	-	-	-	-	-
ISO 8859/8 Hebrew	7H	✓	-	-	-	-	-	✓	-	-	-	-	-	-
Hebrew8	8H	✓	-	-	-	-	-	✓	-	-	-	-	-	-
PC-862, Hebrew	15H	✓	-	-	-	-	-	✓	-	-	-	-	-	-
PC-862, Hebrew	15Q	✓	-	-	-	-	-	✓	-	-	-	-	-	-
Arabic8	8V	-	-	-	-	-	-	-	✓	-	-	-	-	-
HPWARA	9V	-	-	-	-	-	-	-	✓	-	-	-	-	-
PC-864, Arabic	10V	-	-	-	-	-	-	-	✓	-	-	-	-	-
Symbol	19M	-	-	-	✓	-	-	-	-	-	-	-	-	-
Wingdings	579L	-	-	-	-	✓	-	-	-	-	-	-	-	-
ZapfDingbats	14L	-	-	-	-	-	✓	-	-	-	-	-	-	-
OCR A	00	-	-	-	-	-	-	-	-	-	✓	-	-	-
OCR B	10	-	-	-	-	-	-	-	-	-	-	✓	-	-
OCR B Extension	3Q	-	-	-	-	-	-	-	-	-	-	✓	-	-
Code3-9	0Y	-	-	-	-	-	-	-	-	-	-	-	✓	-
EAN/UPC	8Y	-	-	-	-	-	-	-	-	-	-	-	-	✓

The List of the Symbol Sets for PCL 6

Symbol Set Name	Attribute	Font Classification								
		1	2	3	4	5	6	7	8	9
ISO Norwegian	4	✓	✓	✓	-	-	-	-	-	-
ISO Italian	9	✓	✓	✓	-	-	-	-	-	-
ISO 8859-1 Latin 1	14	✓	✓	✓	-	-	-	-	-	✓

Appendix

Symbol Set Name	Attribute	Font Classification								
		1	2	3	4	5	6	7	8	9
ISO Swedish	19	✓	✓	✓	-	-	-	-	-	-
ASCII	21	✓	✓	✓	-	-	-	✓	✓	-
ISO United Kingdom	37	✓	✓	✓	-	-	-	-	-	-
ISO French	38	✓	✓	✓	-	-	-	-	-	-
ISO German	39	✓	✓	✓	-	-	-	-	-	-
Legal	53	✓	✓	✓	-	-	-	-	-	✓
ISO 8859-2 Latin 2	78	✓	✓	✓	-	-	-	-	-	✓
ISO Spanish	83	✓	✓	✓	-	-	-	-	-	-
Roman-9	149	✓	✓	✓	-	-	-	-	-	-
PS Math	173	✓	✓	✓	-	-	-	✓	✓	-
ISO 8859-9 Latin 5	174	✓	✓	✓	-	-	-	-	-	✓
Windows 3.1 Latin 5	180	✓	✓	✓	-	-	-	-	-	-
Microsoft Publishing	202	✓	✓	✓	-	-	-	-	-	-
ISO 8859/10 Latin 6	206	✓	✓	✓	-	-	-	-	-	✓
DeskTop	234	✓	✓	✓	-	-	-	-	-	-
Math-8	269	✓	✓	✓	-	-	-	✓	✓	-
Roman-8	277	✓	✓	✓	-	-	-	-	-	✓
Windows 3.1 Latin 2	293	✓	✓	✓	-	-	-	-	-	-
Pc1004	298	✓	✓	✓	-	-	-	-	-	-
ISO 8859-15 Latin 9	302	✓	✓	✓	-	-	-	-	-	✓
PC-Turkish	308	✓	✓	✓	-	-	-	-	-	-
Windows 3.0	309	✓	✓	✓	-	-	-	-	-	-
PS Text	330	✓	✓	✓	-	-	-	-	-	-
PC-8	341	✓	✓	✓	-	-	-	-	-	✓
PC-8 D/N	373	✓	✓	✓	-	-	-	-	-	✓
MC Text	394	✓	✓	✓	-	-	-	-	-	-
PC-850	405	✓	✓	✓	-	-	-	-	-	✓
PcEur858	437	✓	✓	✓	-	-	-	-	-	-
Pi Font	501	✓	✓	✓	-	-	-	-	-	-
PC852	565	✓	✓	✓	-	-	-	-	-	-

Appendix

Symbol Set Name	Attribute	Font Classification								
		1	2	3	4	5	6	7	8	9
Unicode 3.0	590	✓	✓	✓	-	-	-	✓	✓	-
WBALT	620	✓	✓	✓	-	-	-	-	-	-
Windows 3.1 Latin 1	629	✓	✓	✓	-	-	-	-	-	-
PC-755	853	✓	✓	✓	-	-	-	-	-	-
Wingdings	18540	-	-	-	-	✓	-	-	-	-
Symbol	621	-	-	-	✓	-	-	-	-	-
ZapfDingbats	460	-	-	-	-	-	✓	-	-	-
PC-866, Cyrillic	114	✓	✓	-	-	-	-	-	-	-
Greek8	263	✓	✓	-	-	-	-	-	-	-
Windows Greek	295	✓	✓	-	-	-	-	-	-	-
Windows Cyrillic	306	✓	✓	-	-	-	-	-	-	-
PC-851, Greek	327	✓	✓	-	-	-	-	-	-	-
ISO 8859/5 Cyrillic	334	✓	✓	-	-	-	-	-	-	✓
PC-8, Greek	391	✓	✓	-	-	-	-	-	-	-
ISO 8859/7 Greek	398	✓	✓	-	-	-	-	-	-	-
PC-866 UKR	466	✓	✓	-	-	-	-	-	-	-
Hebrew7	8	✓	-	-	-	-	-	✓	-	-
ISO 8859/8 Hebrew	232	✓	-	-	-	-	-	✓	-	-
Hebrew8	264	✓	-	-	-	-	-	✓	-	-
PC-862, Hebrew	488	✓	-	-	-	-	-	✓	-	-
Arabic8	278	-	-	-	-	-	-	-	✓	-
HPWARA	310	-	-	-	-	-	-	-	✓	-
PC-864, Arabic	342	-	-	-	-	-	-	-	✓	-

Regulatory Information

Standards and Approvals for European Model

Low voltage directive 2006/95/EC	EN60950-1
----------------------------------	-----------

Appendix

EMC directive 2004/108/EC	EN55022 Class B EN61000-3-2 EN61000-3-3 EN55024
R&TTE directive 1999/5/EC	EN300 328 EN301 489-1 EN301 489-17 TBR21 EN60950-1

For European users

We, Seiko Epson Corporation, hereby declare that the following equipment Model is in compliance with the essential requirements and other relevant provisions of Directive 1999/5/EC:

C511C

For use only in Ireland, UK, Austria, Germany, Liechtenstein, Switzerland, France, Belgium, Luxemburg, Netherlands, Italy, Portugal, Spain, Denmark, Finland, Norway, Sweden, Iceland, Croatia, Cyprus, Greece, Slovenia, Malta, Bulgaria, Czech, Estonia, Hungary, Latvia, Lithuania, Poland, Romania, and Slovakia.

Epson cannot accept responsibility for any failure to satisfy the protection requirements resulting from a non-recommended modification of the products.



German Blue Angel

This printer meets the standards for the German Blue Angel. See the following website for the specifications required for the Blue Angel standard.

<http://www.epson.de/blauerengel>

Restrictions on Copying

Observe the following restrictions to ensure the responsible and legal use of the printer.

Copying of the following items is prohibited by law:

- Bank bills, coins, government-issued marketable securities, government bond securities, and municipal securities
- Unused postage stamps, pre-stamped postcards, and other official postal items bearing valid postage
- Government-issued revenue stamps, and securities issued according to legal procedure

Exercise caution when copying the following items:

- Private marketable securities (stock certificates, negotiable notes, checks, etc.), monthly passes, concession tickets, etc.
- Passports, driver's licenses, warrants of fitness, road passes, food stamps, tickets, etc.

Note:

Copying these items may also be prohibited by law.

Appendix

Responsible use of copyrighted materials:

Printers can be misused by improperly copying copyrighted materials. Unless acting on the advice of a knowledgeable attorney, be responsible and respectful by obtaining the permission of the copyright holder before copying published material.

Saving Power

The printer enters sleep mode or turns off automatically if no operations are performed for a set period. You can adjust the time before power management is applied. Any increase will affect the printer's energy efficiency. Please consider the environment before making any change.

Saving Power - Control Panel

1. Enter **Setup** from the home screen, and then select **System Administration**.
2. Select **Common Settings**.
3. Select **Power Off Timer** or **Sleep Timer**, and then make settings.

Transporting the Printer

When you need to transport the printer to move or for repairs, follow the steps below to pack the printer.

 **Important:**

- When storing or transporting the printer, avoid tilting it, placing it vertically, or turning it upside down; otherwise ink may leak.
- Leave the ink cartridge installed. Removing the cartridge can dry out the print head and may prevent the printer from printing.
- Leave the maintenance box installed; otherwise ink may leak during transporting.

1. Turn off the printer by pressing the  button.
2. Make sure the power light turns off, and then unplug the power cord.

 **Important:**

Unplug the power cord when the power light is off. Otherwise, the print head does not return to the home position causing the ink to dry, and printing may become impossible.

3. Disconnect all cables such as the power cord and USB cable.
4. Remove all of the paper from the printer.
5. Make sure there are no originals on the printer.
6. Store the paper support and the output tray.

Appendix

7. Uninstall the optional paper cassette if it is installed.
8. Pack the printer in its box, using the protective materials.

Note:

If print quality has declined the next time you print, clean and align the print head.

Related Information

- ➔ [“Part Names and Functions” on page 16](#)
- ➔ [“Checking and Cleaning the Print Head” on page 115](#)
- ➔ [“Aligning the Print Head” on page 117](#)

Accessing an External USB Device From a Computer

You can write or read data on an external USB device such as a USB flash drive that has been inserted in the printer from a computer.



Important:

- When sharing an external device inserted in the printer between computers connected over USB and over a network, write access is only allowed to the computers that are connected by the method you selected on the printer. To write to the external USB device, enter the **Setup** on the control panel, and then select **System Administration > Printer Settings > Memory Device Interface > File Sharing** and a connection method. Data can be read by computers connected over USB and over a network.
- To write to an external USB device connected to the computer over a network, enter the **Setup** on the control panel, and then select **System Administration > Printer Settings > Memory Device Interface > File Sharing > Wi-Fi/Network**.

Note:

It takes a while to recognize data from a computer if a large external USB device, such as 2TB HDD, is connected.

Windows

Select an external USB device in **Computer** or **My Computer**. The data on the external USB device is displayed.

Note:

*If you connected the printer to the network without using the software disk or Web Installer, map a USB port as a network drive. Open **Run** and enter a printer name \\EPSONXXXXX or a printer's IP address \\XXX.XXX.XXX.XXX to **Open**. Right-click a device icon displayed to assign the network. The network drive appears in **Computer** or **My Computer**.*

Mac OS X

Select a corresponding device icon. The data on the external USB device is displayed.

Note:

- To remove an external USB device, drag the device icon to the trash icon. Otherwise, data in the shared drive may not be displayed correctly when another external USB device is inserted.
- If you connected the printer to the network without using EpsonNet Setup, map a USB port as a network drive. Select **Go > Connect to Server**. Enter a printer name `cifs://EPSONXXXXX` or `smb://EPSONXXXXX` in the **Server Address** and click **Connect**.

Related Information

- ➔ [“Printer Settings” on page 31](#)

➔ [“External USB Device Specifications” on page 169](#)

Installing the Optional Units

Product Name of the Optional Paper Cassette Unit

The following is the product name for the optional paper cassette unit.

250-Sheet Optional Cassette Unit

Installing the Optional Paper Cassette Units



Caution:

Make sure you turn off the printer, unplug the power cord from the printer, and disconnect any cables before starting installation. Otherwise, the power cord may be damaged resulting in fire or electric shock.

1. Turn off the printer by pressing the  button, and then unplug the power cord.
2. Disconnect any connected cables.
3. Remove the optional paper cassette unit from its box, and then remove any protective materials.
4. Lower the printer onto the optional paper cassette unit.

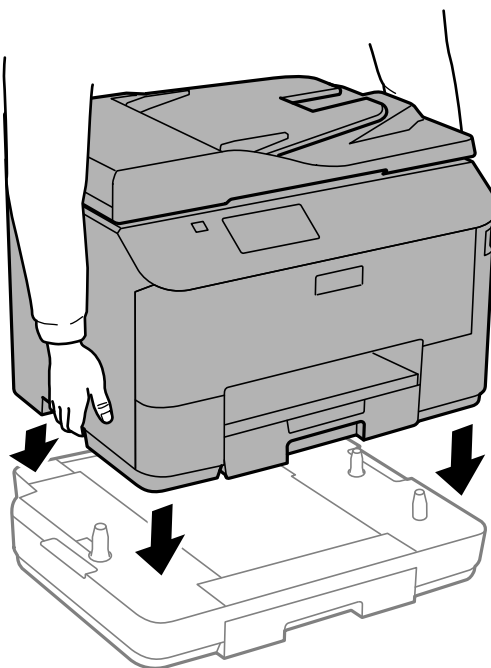

5. Reconnect the power cord and any other cables, and then plug in the printer.
6. Turn on the printer by pressing the  button.

Appendix

- Pull out and reinsert the optional paper cassette unit to check that the optional paper cassette unit is displayed on the **Paper Setup** screen.

Note:

When uninstalling the optional paper cassette unit, turn off the printer, unplug the power cord, disconnect any cables, and then perform the installation procedure in reverse.

Proceed with the printer driver settings.

Setting the Optional Paper Cassette Unit in the Printer Driver

To use the installed optional paper cassette unit, the printer driver needs to acquire the necessary information.

Setting the Optional Paper Cassette Unit in the Printer Driver - Windows

Note:

Log on to your computer as an administrator.

- Open the **Optional Settings** tab from the printer properties.
 - Windows 8.1/Windows 8/Windows Server 2012 R2/Windows Server 2012
Select **Desktop > Settings > Control Panel > View devices and printers in Hardware and Sound**. Right-click on your printer, or press and hold it, select **Printer properties**, and then click the **Optional Settings** tab.
 - Windows 7/Windows Server 2008 R2
Click the start button, and select **Control Panel > View devices and printers in Hardware and Sound**. Right-click on your printer, select **Printer properties**, and then click the **Optional Settings** tab.
 - Windows Vista/Windows Server 2008
Click the start button, and then select **Control Panel > Printers in Hardware and Sound**. Right-click on your printer, select **Property**, and then click **Optional Settings**.
 - Windows XP/Windows Server 2003 R2/Windows Server 2003
Click the start button, and select **Control Panel > Printers and Other Hardware > Printers and Faxes**. Right-click on your printer, select **Property**, and then click the **Optional Settings** tab.
- Select **Acquire from Printer**, and then click **Get**.
Optional Paper Sources information is displayed in **Current Printer Information**.
- Click **OK**.

Setting the Optional Paper Cassette Unit in the Printer Driver - Mac OS X

- Select **System Preferences** from the  menu > **Printers & Scanners** (or **Print & Scan, Print & Fax**), and then select the printer. Click **Options & Supplies > Options** (or **Driver**).
- Set **Lower Cassette** according to the number of paper cassettes.
- Click **OK**.

Using an Email Server

To use email features, such as scan or fax forwarding features, you need to configure the email server.

Configuring an Email Server

Check the following before configuring the email server.

- The printer is connected to the network.
- The email server information, such as the documents from your service provider that you used to setup the email on your computer.

Note:

If you use a free email service, such as Internet email, search the Internet to get the email server information you need.

1. Enter **Setup** from the home screen.
2. Select **System Administration > Wi-Fi/Network Settings > Advanced Setup**.
3. Select **Email Server > Server Settings**.
4. Select the authentication method.

Select the authentication method of the email server you are using.



Important:

The following authentication methods are available. SSL and STARTTLS are not supported.

- None
- SMTP (SMTP AUTH)
- POP Before SMTP

Contact your internet service provider to confirm the authentication method of the email server.

The printer may not be able to communicate with an email server even if the authentication method is available since security may be enhanced (for example SSL communication is necessary). Visit the Epson support website for the latest information.

<http://www.epson.eu/Support> (Europe)

<http://support.epson.net/> (outside Europe)

5. Make the appropriate settings.

The necessary settings vary depending on the authentication method. Enter the information for the email server you are using.

6. Press **OK**.

Note:

- If an error message is displayed, check if the email server settings are correct.*
- When you cannot send an email even if you have completed the settings, check the authentication method for the email server you are using.*

Related Information

➔ [“Email Server Setting Items” on page 186](#)

Email Server Setting Items

Items	Explanations
Authentication Method	Displays the selected authentication method.
Authenticated Account	If you select SMTP-AUTH or POP before SMTP as the Authentication Method , enter the user name (email address) registered to the email server within 30 characters or less.
Authenticated Password	If you select SMTP-AUTH or POP before SMTP as the Authentication Method , enter the password of the authenticated account within 20 characters or less.
Sender's Email Address	Specify the email address that the printer uses to send emails. You can specify the existing email address. To make it clear that the email is being sent from the printer, you can acquire an address specifically for the printer and enter it here.
SMTP Server Address	Enter the server address of the server that sends the email (SMTP server).
SMTP Server Port Number	Enter the port number of the server that sends the email (SMTP server).
POP3 Server Address	If you select POP before SMTP as the Authentication Method , enter the server address of the server that receives the email (POP3 server).
POP3 Server Port Number	If you select POP before SMTP as the Authentication Method , enter the port number of the email server that receives the email (POP3 server).

Checking an Email Server Connection

1. Enter **Setup** from the home screen.
2. Select **System Administration > Wi-Fi/Network Settings > Advanced Setup**.
3. Select **Email Server > Connection Check** to check that the printer is connected to the email server.

Note:

- If an error message is displayed, check if the email server settings are correct.
- When you cannot send an email even if the connection check succeeds, check the authentication method for the email server you are using.

Where to Get Help

Technical Support Web Site

If you need further help, visit the Epson support website shown below. Select your country or region and go to the support section of your local Epson website. The latest drivers, FAQs, manuals, or other downloadables are also available from the site.

Appendix

<http://support.epson.net/>

<http://www.epson.eu/Support> (Europe)

If your Epson product is not operating properly and you cannot solve the problem, contact Epson support services for assistance.

Contacting Epson Support

Before Contacting Epson

If your Epson product is not operating properly and you cannot solve the problem using the troubleshooting information in your product manuals, contact Epson support services for assistance. If Epson support for your area is not listed below, contact the dealer where you purchased your product.

Epson support will be able to help you much more quickly if you give them the following information:

- Product serial number
(The serial number label is usually on the back of the product.)
- Product model
- Product software version
(Click **About**, **Version Info**, or a similar button in the product software.)
- Brand and model of your computer
- Your computer operating system name and version
- Names and versions of the software applications you normally use with your product

Note:

Depending on the product, the dial list data for fax and/or network settings may be stored in the product's memory. Due to breakdown or repair of a product, data and/or settings may be lost. Epson shall not be responsible for the loss of any data, for backing up or recovering data and/or settings even during a warranty period. We recommend that you make your own backup data or take notes.

Help for Users in Europe

Check your Pan-European Warranty Document for information on how to contact Epson support.