

# WF-2860 Series User's Guide

## Contents

### About This Manual

Introduction to the Manuals. . . . .	7
Using the Manual to Search for Information. . . . .	7
Marks and Symbols. . . . .	9
Descriptions Used in this Manual. . . . .	9
Operating System References. . . . .	9

### Important Instructions

Safety Instructions. . . . .	11
Safety Instructions for Ink. . . . .	11
Printer Advisories and Warnings. . . . .	12
Advisories and Warnings for Setting Up/ Using the Printer. . . . .	12
Advisories and Warnings for Using the Printer with a Wireless Connection. . . . .	13
Advisories and Warnings for Using the Touchscreen. . . . .	13
Protecting Your Personal Information. . . . .	13

### Printer Basics

Part Names and Functions. . . . .	14
Control Panel. . . . .	16
Basic Screen Configuration. . . . .	17
Icons displayed in the LCD Screen. . . . .	17
Touch Screen Operations. . . . .	18
Basic Operations. . . . .	19
Entering Characters. . . . .	20
Viewing Animations. . . . .	20

### Network Settings

Network Connection Types. . . . .	22
Ethernet Connection. . . . .	22
Wi-Fi Connection. . . . .	22
Wi-Fi Direct (Simple AP) Connection. . . . .	23
Connecting to a Computer. . . . .	23
Connecting to a Smart Device. . . . .	24
Making Wi-Fi Settings from the Printer. . . . .	24
Making Wi-Fi Settings Manually. . . . .	25
Making Wi-Fi Settings by Push Button Setup (WPS). . . . .	26
Making Wi-Fi Settings by PIN Code Setup (WPS). . . . .	27
Making Wi-Fi Direct (Simple AP) Connection Settings. . . . .	28

Making Advanced Network Settings. . . . .	29
Checking the Network Connection Status. . . . .	30
Network Icon. . . . .	31
Checking Detailed Network Information from the Control Panel. . . . .	31
Printing a Network Connection Report. . . . .	31
Printing a Network Status Sheet. . . . .	38
Replacing or Adding New Access Points. . . . .	39
Changing the Connection Method to a Computer. . . . .	39
Changing the Network Connection to Ethernet from the Control Panel. . . . .	40
Disabling Wi-Fi from the Control Panel. . . . .	40
Disconnecting Wi-Fi Direct (Simple AP) Connection from the Control Panel. . . . .	41
Restoring the Network Settings from the Control Panel. . . . .	41

### Preparing the Printer

Loading Papers. . . . .	43
Available Paper and Capacities. . . . .	43
Loading Paper in the Paper Cassette. . . . .	45
Loading Envelopes and Precautions. . . . .	48
List of Paper Type. . . . .	48
Placing Originals. . . . .	49
Available Originals for the ADF. . . . .	49
Placing Originals on the ADF. . . . .	50
Placing Originals on the Scanner Glass. . . . .	51
Managing Contacts. . . . .	53
Registering or Editing Contacts. . . . .	53
Registering or Editing Grouped Contacts. . . . .	53
Register Contacts on a Computer. . . . .	54
Menu Options for Settings. . . . .	55
Menu Options for General Settings. . . . .	56
Menu Options for Supply Status. . . . .	60
Menu Options for Maintenance. . . . .	60
Menu Options for Print Status Sheet. . . . .	61
Menu Options for Print Counter. . . . .	61
Menu Options for User Settings. . . . .	62
Menu Options for Restore Default Settings. . . . .	62
Menu Options for Firmware Update. . . . .	62
Saving Power. . . . .	62
Saving Power - Control Panel. . . . .	63

### Printing

Printing from the Printer Driver on Windows. . . . .	64
--	----

## Contents

Accessing the Printer Driver. . . . .	64	Scanning to the Cloud. . . . .	103
Printing Basics. . . . .	64	Scanning to a Computer (WSD). . . . .	105
Printing on 2-Sides. . . . .	66	Scanning from a Computer. . . . .	107
Printing Several Pages on One Sheet. . . . .	67	Scanning Using Epson Scan 2. . . . .	107
Printing and Stacking in Page Order (Reverse Order Printing). . . . .	68	Scanning from Smart Devices. . . . .	114
Printing a Reduced or Enlarged Document. . . . .	68	Installing Epson iPrint. . . . .	114
Printing One Image on Multiple Sheets for Enlargement (Creating a Poster). . . . .	69	Scanning by Touching Smart Devices to the NFC Tag. . . . .	114
Printing with a Header and Footer. . . . .	75	Scanning Using Epson iPrint. . . . .	115
Printing a Watermark. . . . .	76		
Printing Multiple Files Together. . . . .	77	<b>Faxing</b>	
Printing Using the Color Universal Print Feature. . . . .	77	Setting Up a Fax. . . . .	117
Adjusting the Print Color. . . . .	78	Connecting to a Phone Line. . . . .	117
Printing to Emphasize Thin Lines. . . . .	79	Making Basic Fax Settings. . . . .	120
Printing Clear Bar Codes. . . . .	79	Sending Faxes Using the Printer. . . . .	123
Canceling Printing. . . . .	80	Basic Fax Sending Operations. . . . .	123
Menu Options for the Printer Driver. . . . .	80	Various Ways of Sending Faxes. . . . .	126
Printing from the Printer Driver on Mac OS. . . . .	82	Receiving Faxes on the Printer. . . . .	128
Printing Basics. . . . .	82	Setting Receive Mode. . . . .	128
Printing on 2-Sides. . . . .	84	Various Ways of Receiving Faxes. . . . .	129
Printing Several Pages on One Sheet. . . . .	85	Saving of Received Faxes. . . . .	131
Printing and Stacking in Page Order (Reverse Order Printing). . . . .	85	Sending a Fax from a Computer. . . . .	133
Printing a Reduced or Enlarged Document. . . . .	86	Sending Documents Created Using an Application (Windows). . . . .	133
Adjusting the Print Color. . . . .	87	Sending Documents Created Using an Application (Mac OS). . . . .	135
Canceling Printing. . . . .	87	Receiving Faxes on a Computer. . . . .	137
Menu Options for the Printer Driver. . . . .	87	Setting to Save a Received Fax on a Computer. . . . .	137
Making Operation Settings for the Mac OS Printer Driver. . . . .	89	Receiving Faxes on a Computer and Printing from the Printer. . . . .	137
Printing from Smart Devices. . . . .	90	Canceling Received Faxes on the Computer. . . . .	138
Using Epson iPrint. . . . .	90	Checking for New Faxes (Windows). . . . .	138
Printing by Touching Smart Devices to the NFC Tag. . . . .	91	Checking for New Faxes (Mac OS). . . . .	139
Using Epson Print Enabler. . . . .	92	Using Other Faxing Features. . . . .	140
Using AirPrint. . . . .	93	Printing Fax Report and List. . . . .	140
Canceling the Ongoing Job. . . . .	94	Setting Security for Faxing. . . . .	140
		Menu Options for Faxing. . . . .	141
<b>Copying</b>		Recipient. . . . .	141
Copying Basics. . . . .	95	Fax Settings. . . . .	141
Copying on 2-Sides. . . . .	95	More. . . . .	142
Copying Multiple Originals onto One Sheet. . . . .	96	Menu Options for Fax Settings. . . . .	143
Basic Menu Options for Copying. . . . .	96	Check Fax Connection. . . . .	143
Advanced Menu Options for Copying. . . . .	96	Fax Setting Wizard. . . . .	144
		Receive Settings. . . . .	144
<b>Scanning</b>		Report Settings. . . . .	145
Scanning Using the Control Panel. . . . .	99	Basic Settings. . . . .	146
Scanning to a Computer (Event Manager). . . . .	99	Security Settings. . . . .	147
		Menu Options for User Settings. . . . .	147

Menu Options for Inbox. . . . .	148
---------------------------------	-----

## **Replacing Ink Cartridges and Other Consumables**

Checking the Status of the Remaining Ink and the Maintenance Box. . . . .	149
Checking the Status of the Remaining Ink and the Maintenance Box - Control Panel. . . . .	149
Checking the Status of the Remaining Ink and the Maintenance Box - Windows. . . . .	149
Checking the Status of the Remaining Ink and the Maintenance Box - Mac OS. . . . .	149
Ink Cartridge Codes. . . . .	150
Ink Cartridge Handling Precautions. . . . .	151
Replacing Ink Cartridges. . . . .	153
Maintenance Box Code. . . . .	153
Maintenance Box Handling Precautions. . . . .	153
Replacing a Maintenance Box. . . . .	154
Temporarily Printing with Black Ink. . . . .	154
Temporarily Printing with Black Ink - Control Panel. . . . .	155
Temporarily Printing with Black Ink - Windows. . . . .	155
Temporarily Printing with Black Ink - Mac OS. . . . .	156
Conserving Black Ink when the Black Ink Is Low (for Windows Only). . . . .	157

## **Maintaining the Printer**

Checking and Cleaning the Print Head. . . . .	158
Checking and Cleaning the Print Head - Control Panel. . . . .	158
Checking and Cleaning the Print Head - Windows. . . . .	159
Checking and Cleaning the Print Head - Mac OS. . . . .	159
Aligning the Print Head. . . . .	159
Aligning the Print Head - Control Panel. . . . .	159
Cleaning the Paper Path. . . . .	161
Cleaning the Paper Path for Ink Smears. . . . .	161
Cleaning the Paper Path for Paper Feeding Problems. . . . .	161
Cleaning the ADF. . . . .	163
Cleaning the Scanner Glass. . . . .	164
Cleaning the Translucent Film. . . . .	165

## **Network Service and Software Information**

Application for Configuring Printer Operations (Web Config). . . . .	168
Running Web Config on a Web Browser. . . . .	168
Running Web Config on Windows. . . . .	169
Running Web Config on Mac OS. . . . .	169
Application for Scanning Documents and Images (Epson Scan 2). . . . .	169
Adding the Network Scanner. . . . .	170
Application for Configuring Scanning Operations from the Control Panel (Epson Event Manager). . . . .	171
Application for Configuring Fax Operations and Sending Faxes (FAX Utility). . . . .	171
Application for Sending Faxes (PC-FAX Driver). . . . .	172
Application for Laying Out Photos (Epson Easy Photo Print). . . . .	172
Application for Printing Web Pages (E-Web Print). . . . .	173
Application for Scanning and Transferring Images (Easy Photo Scan). . . . .	173
Software Update Tools (EPSON Software Updater). . . . .	174
Application for Configuring Multiple Devices (EpsonNet Config). . . . .	175
Installing the Latest Applications. . . . .	175
Updating the Printer's Firmware using the Control Panel. . . . .	176
Uninstalling Applications. . . . .	177
Uninstalling Applications - Windows. . . . .	177
Uninstalling Applications - Mac OS. . . . .	178
Printing Using a Network Service. . . . .	179

## **Solving Problems**

Checking the Printer Status. . . . .	180
Checking Messages on the LCD Screen. . . . .	180
Checking the Printer Status - Windows. . . . .	181
Checking the Printer Status - Mac OS. . . . .	181
Checking the Software Status. . . . .	182
Removing Jammed Paper. . . . .	182
Paper Does Not Feed Correctly. . . . .	182
Paper Jams. . . . .	183
Paper Feeds at a Slant. . . . .	183
Several Sheets of Paper are Fed at a Time. . . . .	183
Original Does Not Feed in the ADF. . . . .	183
Power and Control Panel Problems. . . . .	184
Power Does Not Turn On. . . . .	184

## Contents

Power Does Not Turn Off. . . . .	184	Cannot Cancel Printing from a Computer Running Mac OS X v10.6.8. . . . .	200
Power Turns Off Automatically. . . . .	184	Cannot Start Scanning. . . . .	200
LCD Screen Gets Dark. . . . .	184	Scanned Image Problems. . . . .	201
Cannot Print from a Computer. . . . .	184	Uneven Colors, Dirt, Spots, and so on Appear when Scanning from the Scanner Glass. . . . .	201
Checking the Connection (USB). . . . .	184	Straight Lines Appear when Scanning from ADF. . . . .	202
Checking the Connection (Network). . . . .	185	The Image Quality Is Rough. . . . .	202
Checking the Software and Data. . . . .	186	Offset Appears in the Background of Images. . . . .	202
Checking the Printer Status from the Computer (Windows). . . . .	188	Text is Blurred. . . . .	202
Checking the Printer Status from the Computer (Mac OS). . . . .	188	Moiré Patterns (Web-Like Shadows) Appear. . . . .	203
When You Cannot Make Network Settings. . . . .	189	Cannot Scan the Correct Area on the Scanner Glass. . . . .	203
Cannot Connect from Devices Even Though Network Settings are No Problems. . . . .	189	Text is Not Recognized Correctly when Saving as a Searchable PDF. . . . .	204
Checking the SSID Connected to the Printer. . . . .	191	Cannot Solve Problems in the Scanned Image. . . . .	204
Checking the SSID for the Computer. . . . .	191	Other Scanning Problems. . . . .	205
Cannot Print from an iPhone or iPad. . . . .	192	Scanning Is Too Slow. . . . .	205
Printout Problems. . . . .	192	Scanning Stops when Scanning to PDF/ Multi-TIFF. . . . .	205
Printout is Scuffed or Color is Missing. . . . .	192	Problems when Sending and Receiving Faxes. . . . .	205
Banding or Unexpected Colors Appear. . . . .	193	Cannot Send or Receive Faxes. . . . .	205
Colored Banding Appears at Intervals of Approximately 3.3 cm. . . . .	193	Cannot Send Faxes. . . . .	207
Blurry Prints, Vertical Banding, or Misalignment. . . . .	194	Cannot Send Faxes to a Specific Recipient. . . . .	207
Print Quality is Poor. . . . .	194	Cannot Send Faxes at a Specified Time. . . . .	207
Paper Is Smearred or Scuffed. . . . .	195	Cannot Receive Faxes. . . . .	207
Paper is Smearred During Automatic 2-Sided Printing. . . . .	196	Memory Full Error Occurs. . . . .	208
Printed Photos are Sticky. . . . .	197	Sent Fax Quality Is Poor. . . . .	208
Images or Photos are Printed in Unexpected Colors. . . . .	197	Faxes Are Sent at the Wrong Size. . . . .	209
Cannot Print Without Margins. . . . .	197	Received Fax Quality Is Poor. . . . .	209
Edges of the Image are Cropped During Borderless Printing. . . . .	197	Received Faxes Are Not Printed. . . . .	209
The Position, Size, or Margins of the Printout Are Incorrect. . . . .	198	Pages are Blank or only a Small Amount of Text is Printed on the Second Page in Received Faxes. . . . .	210
Printed Characters Are Incorrect or Garbled. . . . .	198	Other Faxing Problems. . . . .	210
The Printed Image Is Inverted. . . . .	198	Cannot Make Calls on the Connected Telephone. . . . .	210
Mosaic-Like Patterns in the Prints. . . . .	198	Answering Machine Cannot Answer Voice Calls. . . . .	210
Uneven Colors, Smears, Dots, or Straight Lines Appear in the Copied Image. . . . .	199	Sender's Fax Number Not Displayed on Received Faxes or the Number Is Wrong. . . . .	210
Moiré (Cross-Hatch) Patterns Appear in the Copied Image. . . . .	199	Other Problems. . . . .	210
An Image of the Reverse Side of the Original Appears in the Copied Image. . . . .	199	Slight Electric Shock when Touching the Printer. . . . .	210
The Printout Problem Could Not be Cleared. . . . .	199	Operation Sounds Are Loud. . . . .	211
Other Printing Problems. . . . .	200	The Date and Time Are Incorrect. . . . .	211
Printing Is Too Slow. . . . .	200	Application Is Blocked by a Firewall (for Windows Only). . . . .	211
Printing Slows Down Dramatically During Continuous Printing. . . . .	200		

**Appendix**

Technical Specifications. . . . .	212
Printer Specifications. . . . .	212
Scanner Specifications. . . . .	213
Interface Specifications. . . . .	213
Fax Specifications. . . . .	213
Network Function List. . . . .	214
Wi-Fi Specifications. . . . .	215
Ethernet Specifications. . . . .	215
Security Protocol. . . . .	216
Supported Third Party Services. . . . .	216
Dimensions. . . . .	216
Electrical Specifications. . . . .	216
Environmental Specifications. . . . .	217
System Requirements. . . . .	217
Regulatory Information. . . . .	218
Standards and Approvals. . . . .	218
German Blue Angel. . . . .	219
Restrictions on Copying. . . . .	219
Transporting the Printer. . . . .	219
Copyright. . . . .	221
Trademarks. . . . .	222
Where to Get Help. . . . .	223
Technical Support Web Site. . . . .	223
Contacting Epson Support. . . . .	223

# About This Manual

---

## Introduction to the Manuals

The following manuals are supplied with your Epson printer. As well as the manuals, check the various types of help information available from the printer itself or from the Epson software applications.

Important Safety Instructions (paper manual)

Provides you with instructions to ensure the safe use of this printer.

Start Here (paper manual)

Provides you with information on setting up the printer, installing the software, using the printer, and so on.

User's Guide (digital manual)

This manual. Provides overall information and instructions on using the printer, on network settings when using the printer on a network, and on solving problems.

You can obtain the latest versions of the above manuals with the following methods.

Paper manual

Visit the Epson Europe support website at <http://www.epson.eu/Support>, or the Epson worldwide support website at <http://support.epson.net/>.

Digital manual

Start EPSON Software Updater on your computer. EPSON Software Updater checks for available updates of Epson software applications and the digital manuals, and allows you to download the latest ones.

### Related Information

➔ [“Software Update Tools \(EPSON Software Updater\)” on page 174](#)

---

## Using the Manual to Search for Information

The PDF manual allows you to search for information you are looking for by keyword, or jump directly to specific sections using the bookmarks. You can also print only the pages you need. This section explains how to use a PDF manual that has been opened in Adobe Reader X on your computer.

## About This Manual

### Searching by keyword

Click **Edit > Advanced Search**. Enter the keyword (text) for information you want to find in the search window, and then click **Search**. Hits are displayed as a list. Click one of the displayed hits to jump to that page.

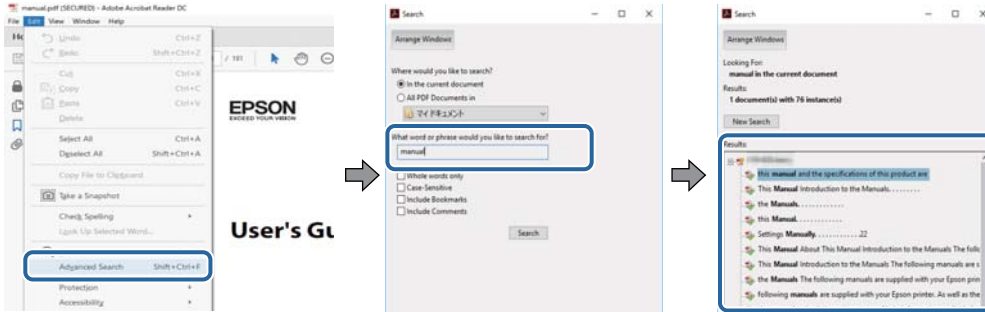

### Jumping directly from bookmarks

Click a title to jump to that page. Click + or > to view the lower level titles in that section. To return to the previous page, perform the following operation on your keyboard.

- ❑ Windows: Hold down **Alt**, and then press **←**.
- ❑ Mac OS: Hold down the command key, and then press **←**.

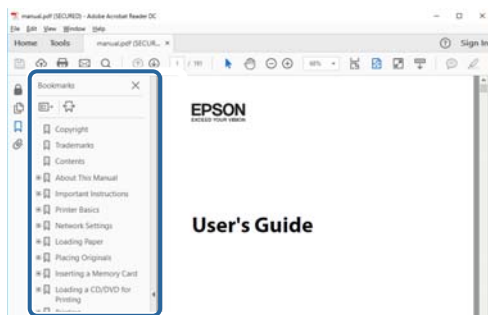

### Printing only the pages you need

You can extract and print only the pages you need. Click **Print** in the **File** menu, and then specify the pages you want to print in **Pages in Pages to Print**.

- ❑ To specify a series of pages, enter a hyphen between the start page and the end page.  
Example: 20-25
- ❑ To specify pages that are not in series, divide the pages with commas.  
Example: 5, 10, 15

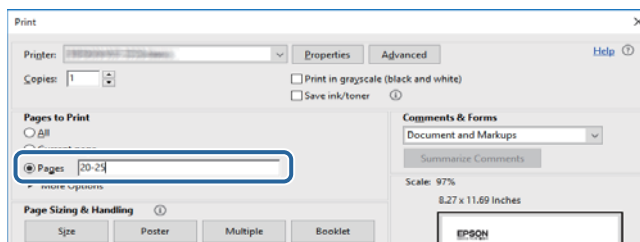



---

## Marks and Symbols

**Caution:**

*Instructions that must be followed carefully to avoid bodily injury.*

**Important:**

*Instructions that must be observed to avoid damage to your equipment.*

**Note:**

*Provides complementary and reference information.*

**➔ Related Information**

Links to related sections.

---

## Descriptions Used in this Manual

- Screenshots of the printer driver and the Epson Scan 2 (scanner driver) screens are from Windows 10 or macOS High Sierra. The content displayed on the screens varies depending on the model and situation.
- Illustrations of the printer used in this manual are examples only. Although there may be slight differences depending on the model, the method of operation is the same.
- Some of the menu items on the LCD screen vary depending on the model and settings.

---

## Operating System References

### Windows

In this manual, terms such as "Windows 10", "Windows 8.1", "Windows 8", "Windows 7", "Windows Vista", "Windows XP", "Windows Server 2016", "Windows Server 2012 R2", "Windows Server 2012", "Windows Server 2008 R2", "Windows Server 2008", "Windows Server 2003 R2", and "Windows Server 2003" refer to the following operating systems. Additionally, "Windows" is used to refer to all versions.

- Microsoft® Windows® 10 operating system
- Microsoft® Windows® 8.1 operating system
- Microsoft® Windows® 8 operating system
- Microsoft® Windows® 7 operating system
- Microsoft® Windows Vista® operating system
- Microsoft® Windows® XP operating system
- Microsoft® Windows® XP Professional x64 Edition operating system
- Microsoft® Windows Server® 2016 operating system
- Microsoft® Windows Server® 2012 R2 operating system
- Microsoft® Windows Server® 2012 operating system

## About This Manual

- Microsoft® Windows Server® 2008 R2 operating system
- Microsoft® Windows Server® 2008 operating system
- Microsoft® Windows Server® 2003 R2 operating system
- Microsoft® Windows Server® 2003 operating system

### Mac OS

In this manual, "Mac OS" is used to refer to macOS High Sierra, macOS Sierra, OS X El Capitan, OS X Yosemite, OS X Mavericks, OS X Mountain Lion, Mac OS X v10.7.x, and Mac OS X v10.6.8.

# Important Instructions

---

## Safety Instructions

Read and follow these instructions to ensure safe use of this printer. Make sure you keep this manual for future reference. Also, be sure to follow all warnings and instructions marked on the printer.

- Some of the symbols used on your printer are to ensure safety and proper use of the printer. Visit the following Web site to learn the meaning of the symbols.  
<http://support.epson.net/symbols>
- Use only the power cord supplied with the printer and do not use the cord with any other equipment. Use of other cords with this printer or the use of the supplied power cord with other equipment may result in fire or electric shock.
- Be sure your AC power cord meets the relevant local safety standard.
- Never disassemble, modify, or attempt to repair the power cord, plug, printer unit, scanner unit, or options by yourself, except as specifically explained in the printer's manuals.
- Unplug the printer and refer servicing to qualified service personnel under the following conditions:  
The power cord or plug is damaged; liquid has entered the printer; the printer has been dropped or the casing damaged; the printer does not operate normally or exhibits a distinct change in performance. Do not adjust controls that are not covered by the operating instructions.
- Place the printer near a wall outlet where the plug can be easily unplugged.
- Do not place or store the printer outdoors, near excessive dirt or dust, water, heat sources, or in locations subject to shocks, vibrations, high temperature or humidity.
- Take care not to spill liquid on the printer and not to handle the printer with wet hands.
- Keep the printer at least 22 cm away from cardiac pacemakers. Radio waves from this printer may adversely affect the operation of cardiac pacemakers.
- If the LCD screen is damaged, contact your dealer. If the liquid crystal solution gets on your hands, wash them thoroughly with soap and water. If the liquid crystal solution gets into your eyes, flush them immediately with water. If discomfort or vision problems remain after a thorough flushing, see a doctor immediately.
- Avoid using a telephone during an electrical storm. There may be a remote risk of electric shock from lightning.
- Do not use a telephone to report a gas leak in the vicinity of the leak.

## Safety Instructions for Ink

- Be careful when you handle used ink cartridges, as there may be some ink around the ink supply port.
  - If ink gets on your skin, wash the area thoroughly with soap and water.
  - If ink gets into your eyes, flush them immediately with water. If discomfort or vision problems continue after a thorough flushing, see a doctor immediately.
  - If ink gets into your mouth, see a doctor right away.
- Do not disassemble the ink cartridge and the maintenance box; otherwise ink may get into your eyes or on your skin.

## Important Instructions

- ❑ Do not shake ink cartridges too vigorously and do not drop them. Also, be careful not to squeeze them or tear their labels. Doing so may cause ink leakage.
- ❑ Keep ink cartridges and maintenance box out of the reach of children.

---



## Printer Advisories and Warnings

Read and follow these instructions to avoid damaging the printer or your property. Make sure you keep this manual for future reference.

### Advisories and Warnings for Setting Up/Using the Printer

- ❑ Do not block or cover the vents and openings in the printer.
- ❑ Use only the type of power source indicated on the printer's label.
- ❑ Avoid using outlets on the same circuit as photocopiers or air control systems that regularly switch on and off.
- ❑ Avoid electrical outlets controlled by wall switches or automatic timers.
- ❑ Keep the entire computer system away from potential sources of electromagnetic interference, such as loudspeakers or the base units of cordless telephones.
- ❑ The power-supply cords should be placed to avoid abrasions, cuts, fraying, crimping, and kinking. Do not place objects on top of the power-supply cords and do not allow the power-supply cords to be stepped on or run over. Be particularly careful to keep all the power-supply cords straight at the ends and the points where they enter and leave the transformer.
- ❑ If you use an extension cord with the printer, make sure that the total ampere rating of the devices plugged into the extension cord does not exceed the cord's ampere rating. Also, make sure that the total ampere rating of all devices plugged into the wall outlet does not exceed the wall outlet's ampere rating.
- ❑ If you plan to use the printer in Germany, the building installation must be protected by a 10 or 16 amp circuit breaker to provide adequate short-circuit protection and over-current protection for the printer.
- ❑ When connecting the printer to a computer or other device with a cable, ensure the correct orientation of the connectors. Each connector has only one correct orientation. Inserting a connector in the wrong orientation may damage both devices connected by the cable.
- ❑ Place the printer on a flat, stable surface that extends beyond the base of the printer in all directions. The printer will not operate properly if it is tilted at an angle.
- ❑ When storing or transporting the printer, avoid tilting it, placing it vertically, or turning it upside down; otherwise ink may leak.
- ❑ Allow space above the printer so that you can fully raise the document cover.
- ❑ Leave enough space in front of the printer for the paper to be fully ejected.
- ❑ Avoid places subject to rapid changes in temperature and humidity. Also, keep the printer away from direct sunlight, strong light, or heat sources.
- ❑ Do not insert objects through the slots in the printer.
- ❑ Do not put your hand inside the printer during printing.
- ❑ Do not touch the white flat cable inside the printer.
- ❑ Do not use aerosol products that contain flammable gases inside or around the printer. Doing so may cause fire.
- ❑ Do not move the print head by hand; otherwise, you may damage the printer.

## Important Instructions

- ❑ Be careful not to trap your fingers when closing the scanner unit.
- ❑ Do not press too hard on the scanner glass when placing the originals.
- ❑ Always turn the printer off using the  button. Do not unplug the printer or turn off the power at the outlet until the  light stops flashing.
- ❑ Before transporting the printer, make sure that the print head is in the home (far right) position and the ink cartridges are in place.
- ❑ If you are not going to use the printer for a long period, be sure to unplug the power cord from the electrical outlet.

## Advisories and Warnings for Using the Printer with a Wireless Connection

- ❑ Radio waves from this printer may negatively affect the operation of medical electronic equipment, causing them to malfunction. When using this printer inside medical facilities or near medical equipment, follow directions from the authorized personnel representing the medical facilities, and follow all posted warnings and directions on the medical equipment.
- ❑ Radio waves from this printer may negatively affect the operation of automatically controlled devices such as automatic doors or fire alarms, and could lead to accidents due to malfunction. When using this printer near automatically controlled devices, follow all posted warnings and directions on these devices.

## Advisories and Warnings for Using the Touchscreen

- ❑ The LCD screen may contain a few small bright or dark spots, and because of its features it may have an uneven brightness. These are normal and do not indicate that it is damaged in any way.
- ❑ Only use a dry, soft cloth for cleaning. Do not use liquid or chemical cleaners.
- ❑ The exterior cover of the touchscreen could break if it receives a heavy impact. Contact your dealer if the panel surface chips or cracks, and do not touch or attempt to remove the broken pieces.
- ❑ Press the touchscreen gently with your finger. Do not press force or operate with your nails.
- ❑ Do not use sharp objects such as ball point pens or sharp pencils to perform operations.
- ❑ Condensation inside the touchscreen due to abrupt changes in temperature or humidity may cause performance to deteriorate.

---

## Protecting Your Personal Information

When you give the printer to someone else or dispose of it, erase all the personal information stored in the printer's memory by selecting **Settings > Restore Default Settings > Clear All Data and Settings** on the control panel.

# Printer Basics

## Part Names and Functions

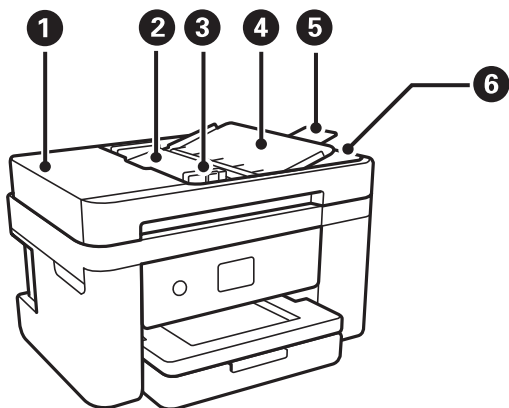

①	ADF (Automatic Document Feeder) cover	Open when removing jammed originals in the ADF.
②	ADF input tray	Feeds originals automatically.
③	ADF edge guide	Feeds originals straight into the printer. Slide to the edge of the originals.
④	ADF document support	Supports originals.
⑤	ADF output tray extension	Holds legal size originals ejected from the ADF. Make sure you extend this when scanning legal size originals using the ADF.
⑥	ADF output tray	Holds originals ejected from the ADF.

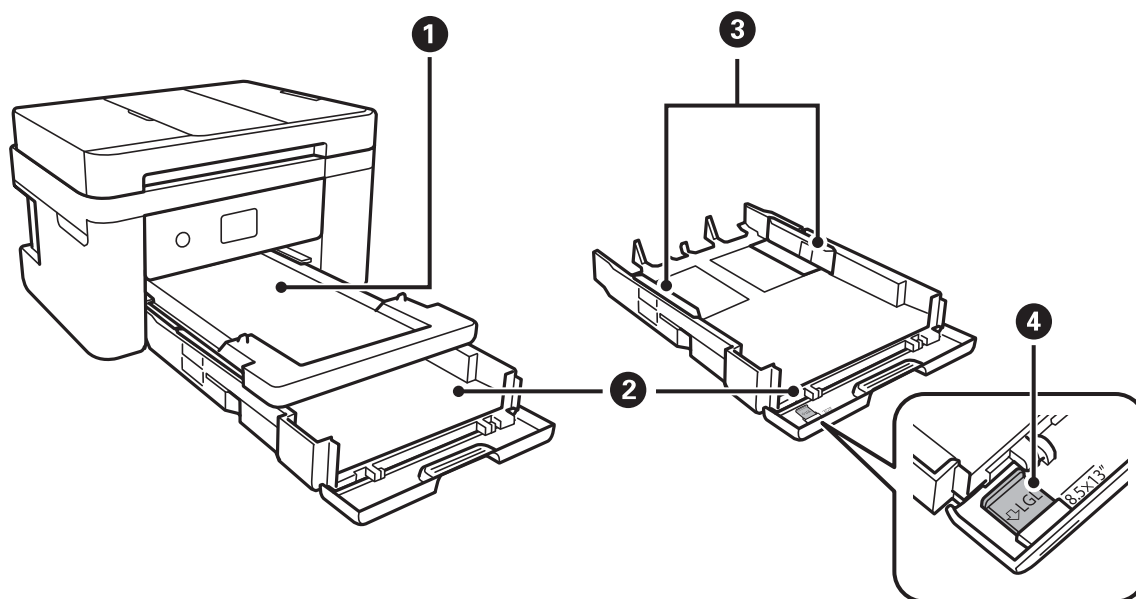

**Printer Basics**

①	Output tray	Holds the ejected paper.
②	Paper cassette	Loads paper.
③	Edge guides	Feeds the paper straight into the printer. Slide to the edges of the paper.
④	Legal paper guide	Slide out to load legal size paper.

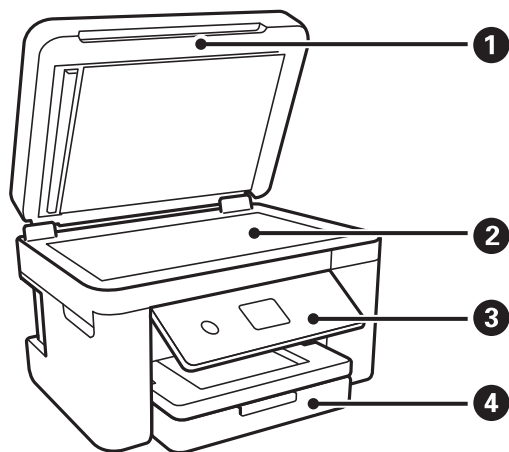

①	Document cover	Blocks external light while scanning.
②	Scanner glass	Place the originals.
③	Control panel	Indicates the printer's status and allows you to make print settings.
④	Front cover	Open to load paper in the paper cassette.

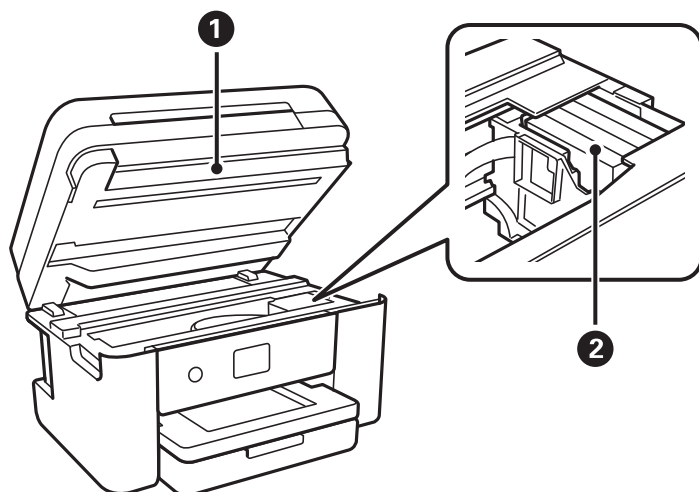

①	Scanner unit	Scans placed originals. Open when replacing ink cartridges or removing jammed paper inside the printer. This unit should usually be kept closed.
②	Ink cartridge holder	Install the ink cartridges. Ink is ejected from the print head nozzles underneath.

### Printer Basics

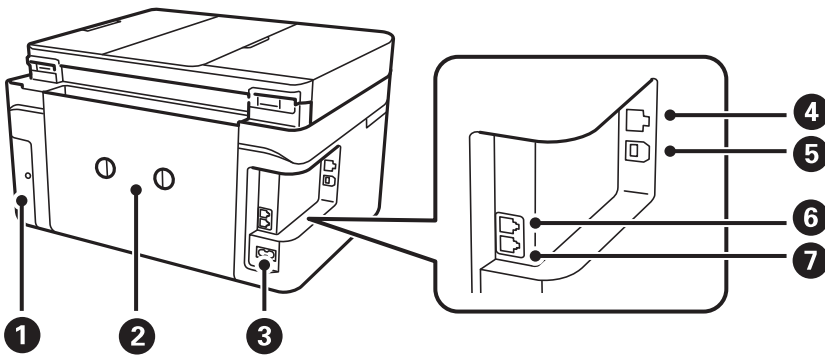

1	Maintenance box cover	Remove when replacing the maintenance box. The maintenance box is a container that collects a very small amount of surplus ink during cleaning or printing.
2	Rear cover	Remove when removing jammed paper.
3	AC inlet	Connects the power cord.
4	LAN port	Connects a LAN cable.
5	USB port	Connects a USB cable to connect with a computer.
6	EXT. port	Connects external phone devices.
7	LINE port	Connects a phone line.

### Control Panel

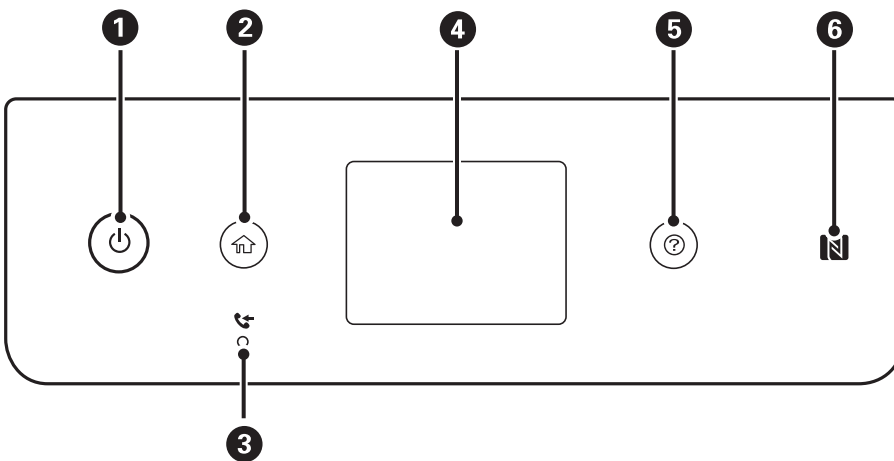

1	Turns the printer on or off. Unplug the power cord when the power light is off.
2	Displays the home screen.
3	Turns on when received documents that have not yet been read, printed, or saved, are stored in the printer's memory.
4	Displays menus and messages.



## Printer Basics

5	Displays the solutions when you are in trouble.
6	Pass a smart device over this mark to print or scan from the smart device directly.

## Basic Screen Configuration

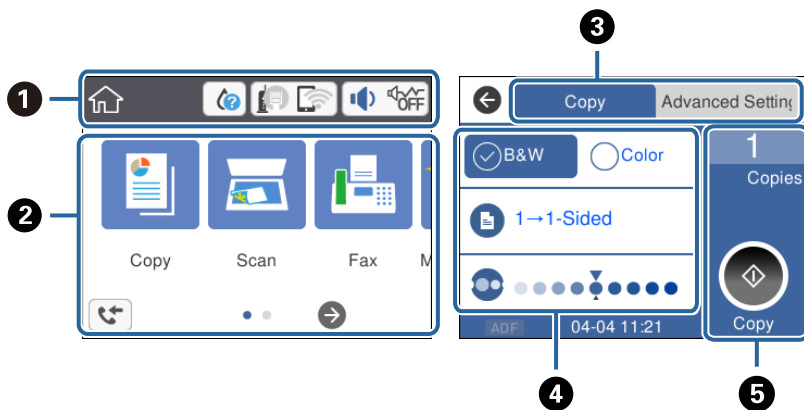

1	Indicates items that have been setup for the printer as icons. Tap the icon to check the current settings or access each setting menu. This action bar is displayed on the home screen only.
2	Displays each menu.
3	Switch tabs.
4	Indicates the setting items. Tap each item to set or change the settings. The grayed out items are not available. Tap the item to check why they are unavailable.
5	Execute the current settings. Available functions vary depending on each menu. This action bar is displayed on the basic settings tab only.

## Icons displayed in the LCD Screen

The following icons are displayed on the LCD screen depending on the printer's status.

	Displays the <b>Supply Status</b> screen. You can check the approximate ink levels and the approximate service life of the maintenance box.
---	--

### Printer Basics

	<p>Indicates the network connection status.</p> <p>Select the icon to check and change the current settings. This is the shortcut for the following menu.</p> <p><b>Settings &gt; General Settings &gt; Network Settings &gt; Wi-Fi Setup</b></p>
	<p>The printer is not connected to a wired (Ethernet) network or unset it.</p>
	<p>The printer is connected to a wired (Ethernet) network.</p>
	<p>The printer is not connected to a wireless (Wi-Fi) network.</p>
	<p>The printer is searching for SSID, unset IP address, or having a problem with a wireless (Wi-Fi) network.</p>
	<p>The printer is connected to a wireless (Wi-Fi) network.</p> <p>The number of bars indicates the signal strength of the connection. The more bars there are, the stronger the connection.</p>
	<p>The printer is not connected to a wireless (Wi-Fi) network in Wi-Fi Direct (Simple AP) mode.</p>
	<p>The printer is connected to a wireless (Wi-Fi) network in Wi-Fi Direct (Simple AP) mode.</p>
	<p>Displays the <b>Device Sound Settings</b> screen. You can set <b>Mute</b> and <b>Quiet Mode</b>.</p> <p>You can also access the <b>Sound</b> menu from this screen. This is the shortcut for the following menu.</p> <p><b>Settings &gt; General Settings &gt; Basic Settings &gt; Sound</b></p>
	<p>Indicates whether or not <b>Quiet Mode</b> is set for the printer. When this feature is enabled, the noise made by printer operations is reduced, but print speed may slow down. However, noises may not be reduced depending on the selected paper type and print quality.</p>
	<p>Indicates that <b>Mute</b> is set for the printer.</p>
	<p>Displays the <b>Fax Data Information</b> screen.</p>
	<p>Indicates that there is additional information. Select the icon to displays the message.</p>
	<p>Indicates a problem with the items. Select the icon to check how to solve the problem.</p>
	<p>Indicates that there is data that has not yet been read, printed, or saved. The number displayed indicates the number of data items.</p>

#### Related Information

- ➔ [“Network Settings” on page 58](#)
- ➔ [“Basic Settings” on page 56](#)

## Touch Screen Operations

The touchscreen is compatible with the following operations.

## Printer Basics

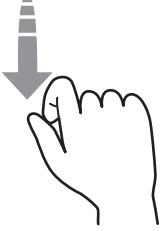
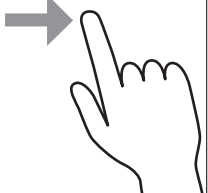
Tap		Press or select the items or the icons.
Flick		Scroll the screen swiftly.
Slide		Hold and move the items around.

## Basic Operations

Tap anywhere on the setting item to switch it on and off.

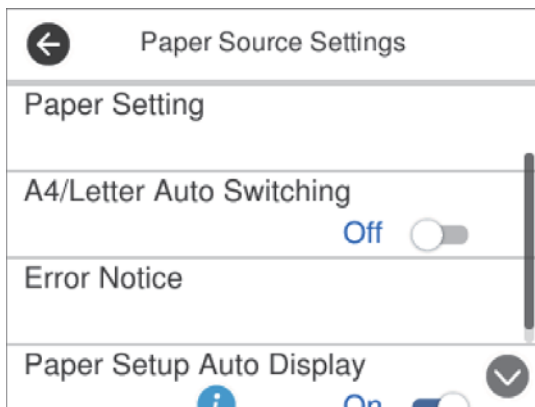

Tap the input field to enter the value, name and so on.

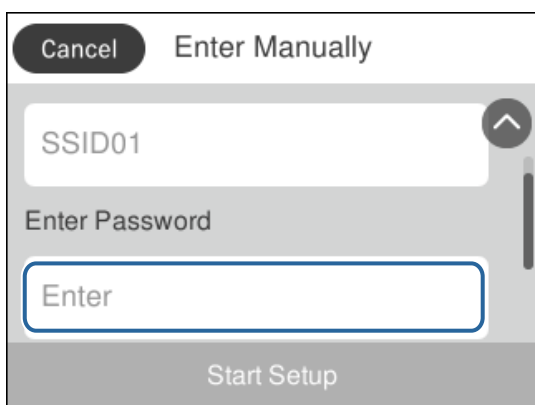

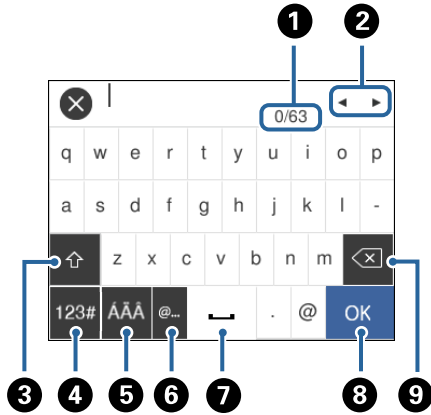

## Entering Characters

You can enter characters and symbols by using on-screen keyboard when you register a contact, make network settings, and so on.



**Note:**

Available icons vary depending on the setting item.

1	Indicates the character count.
2	Moves the cursor to the input position.
3	Switches between upper case and lower case or numbers and symbols.
4	Switches the character type.  : You can enter numbers and symbols.  : You can enter letters.
5	Switches the character type. You can enter alphanumerics and special characters such as umlauts and accents.
6	Enters frequently used email domain addresses or URLs by simply selecting the item.
7	Enters a space.
8	Confirms the entered characters.
9	Deletes a character to the left.

## Viewing Animations

You can view animations of operating instructions such as loading paper or removing jammed paper on the LCD screen.

- ❑ Press  button: Displays the help screen. Tap **How To** and then select the items that you want to view.

### Printer Basics

- Tap **How To** at the bottom of the operation screen: Displays the context-sensitive animation.

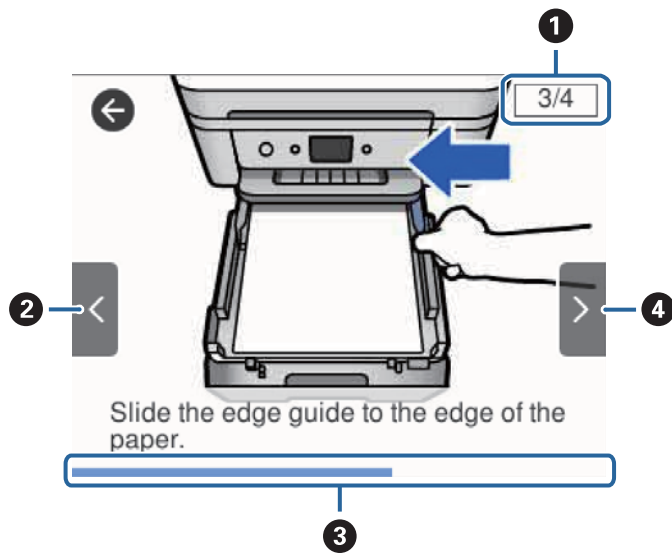

<p>1</p>	<p>Indicates the total number of steps and the current step number. In the example above, it shows step 3 from 4 steps.</p>
<p>2</p>	<p>Returns to the previous step.</p>
<p>3</p>	<p>Indicates your progress through the current step. The animation repeats when the progress bar reaches the end.</p>
<p>4</p>	<p>Moves to next step.</p>

# Network Settings

---

## Network Connection Types

You can use the following connection methods.

### Ethernet Connection

Connect the printer to a hub with an Ethernet cable.

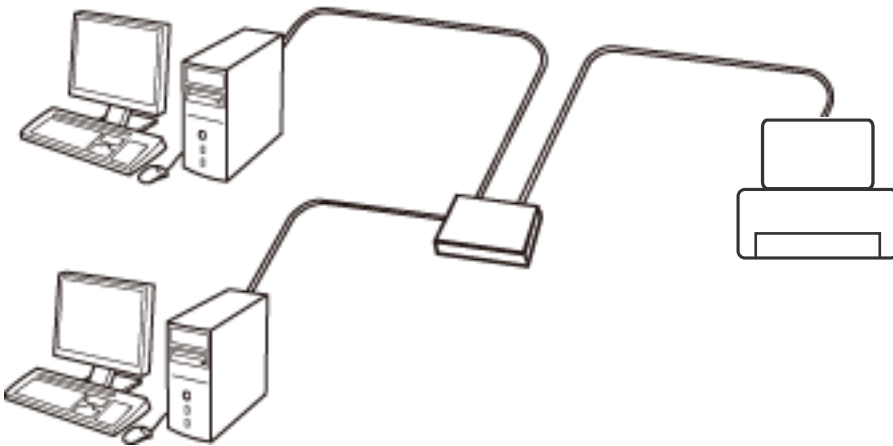

#### Related Information

➔ [“Making Advanced Network Settings” on page 29](#)

### Wi-Fi Connection

Connect the printer and the computer or smart device to the access point. This is the typical connection method for home or office networks where computers are connected by Wi-Fi through the access point.

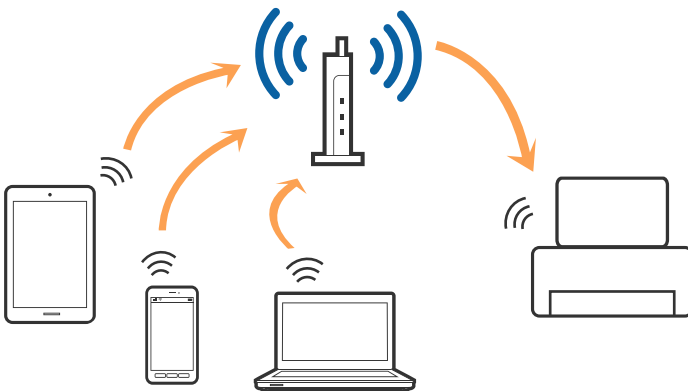

**Related Information**

- ➔ “Connecting to a Computer” on page 23
- ➔ “Connecting to a Smart Device” on page 24
- ➔ “Making Wi-Fi Settings from the Printer” on page 24

## Wi-Fi Direct (Simple AP) Connection

Use this connection method when you are not using Wi-Fi at home or at the office, or when you want to connect the printer and the computer or smart device directly. In this mode, the printer acts as an access point and you can connect up to four devices to the printer without having to use a standard access point. However, devices directly connected to the printer cannot communicate with each other through the printer.

**Note:**

Wi-Fi Direct (Simple AP) connection is a connection method designed to replace Ad Hoc mode.

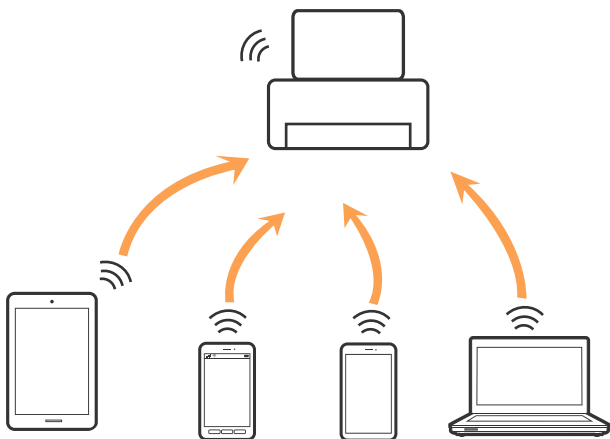

The printer can be connected by Wi-Fi or Ethernet, and Wi-Fi Direct (Simple AP) connection simultaneously. However, if you start a network connection in Wi-Fi Direct (Simple AP) connection when the printer is connected by Wi-Fi, the Wi-Fi is temporarily disconnected.

**Related Information**

- ➔ “Making Wi-Fi Direct (Simple AP) Connection Settings” on page 28

---

## Connecting to a Computer

We recommend using the installer to connect the printer to a computer. You can run the installer using one of the following methods.

- Setting up from the website

Access the following website, and then enter the product name. Go to **Setup**, and then start setting up.

<http://epson.sn>

- Setting up using the software disc (only for the models that come with a software disc and users with computers with disc drives.)

Insert the software disc into the computer, and then follow the on-screen instructions.

## Network Settings

### Selecting the Connection Methods

Follow the on-screen instructions until the following screen is displayed, and then select the connection method of the printer to the computer.

Select the connection type and then click **Next**.

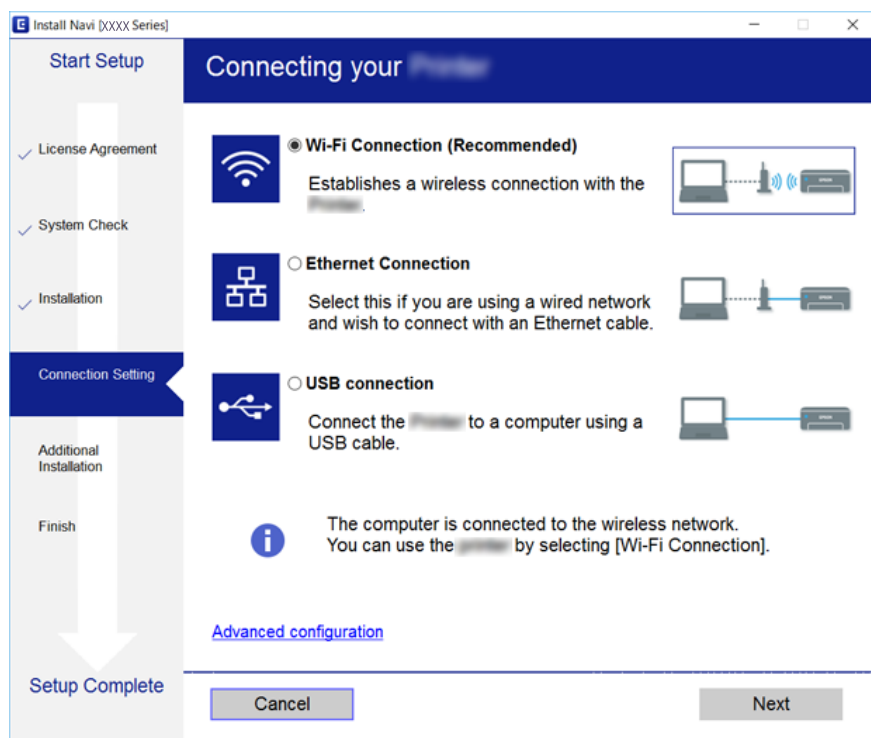

Follow the on-screen instructions.

---

## Connecting to a Smart Device

You can use the printer from a smart device when you connect the printer to the same Wi-Fi network (SSID) as the smart device. To use the printer from a smart device, set up from the following website. Access to the website from the smart device that you want to connect to the printer.

<http://epson.sn> > Setup

**Note:**

*If you want to connect a computer and a smart device to the printer at the same time, we recommend connecting the computer first.*

---

## Making Wi-Fi Settings from the Printer

You can make network settings from the printer's control panel in several ways. Choose the connection method that matches the environment and conditions that you are using.

If you know the information for the access point such as SSID and password, you can make settings manually.

If the access point supports WPS, you can make settings by using push button setup.



## Network Settings

After connecting the printer to the network, connect to the printer from the device that you want to use (computer, smart device, tablet, and so on.)

Make advanced network settings to use a static IP address.

### Related Information

- ➔ “Making Wi-Fi Settings Manually” on page 25
- ➔ “Making Wi-Fi Settings by Push Button Setup (WPS)” on page 26
- ➔ “Making Wi-Fi Settings by PIN Code Setup (WPS)” on page 27
- ➔ “Making Wi-Fi Direct (Simple AP) Connection Settings” on page 28
- ➔ “Making Advanced Network Settings” on page 29

## Making Wi-Fi Settings Manually

You can manually set up the information necessary to connect to an access point from the printer's control panel. To set up manually, you need the SSID and password for an access point.

### Note:

*If you are using an access point with its default settings, the SSID and password are on the label. If you do not know the SSID and password, contact the person who set up the access point, or see the documentation provided with the access point.*

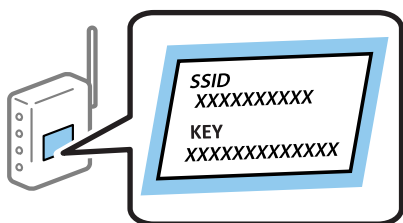

1. Tap  on the home screen.

2. Select **Wi-Fi (Recommended)**.

If the printer has already been connected by Ethernet, select **Router**.

3. Tap **Start Setup**.

If the network connection is already set up, the connection details are displayed. Tap **Change Settings** to change the settings.

If the printer has already been connected by Ethernet, tap **Change to Wi-Fi connection.**, and then select **Yes** after checking the message.

4. Select **Wi-Fi Setup Wizard**.

5. Select the SSID for the access point.

### Note:

- If the SSID you want to connect to is not displayed on the printer's control panel, tap **Search Again** to update the list. If it is still not displayed, tap **Enter Manually**, and then enter the SSID directly.
- If you do not know the SSID, check if it is written on the label of the access point. If you are using the access point with its default settings, use the SSID written on the label.

## Network Settings

6. Tap **Enter Password**, and then enter the password.

**Note:**

- The password is case-sensitive.*
- If you do not know the password, check if it is written on the label of the access point. If you are using the access point with its default settings, use the password written on the label. The password may also be called a "Key", a "Passphrase", and so on.*
- If you do not know the password for the access point, see the documentation provided with the access point, or contact the person who set it up.*

7. When you have finished, tap **OK**.
8. Check the settings, and then tap **Start Setup**.
9. Tap **OK** to finish.

**Note:**

*If you fail to connect, load A4 size plain paper, and then select **Print Check Report** to print a connection report.*

10. Close the **Network Connection Settings** screen.

### Related Information

- ➔ ["Entering Characters" on page 20](#)
- ➔ ["Checking the Network Connection Status" on page 30](#)
- ➔ ["When You Cannot Make Network Settings" on page 189](#)

## Making Wi-Fi Settings by Push Button Setup (WPS)

You can automatically set up a Wi-Fi network by pressing a button on the access point. If the following conditions are met, you can set up by using this method.

- The access point is compatible with WPS (Wi-Fi Protected Setup).
- The current Wi-Fi connection was established by pressing a button on the access point.

**Note:**

*If you cannot find the button or you are setting up using the software, see the documentation provided with the access point.*

1. Tap  on the home screen.

2. Select **Wi-Fi (Recommended)**.

If the printer has already been connected by Ethernet, select **Router**.

3. Tap **Start Setup**.

If the network connection is already set up, the connection details are displayed. Tap **Change Settings** to change the settings.

If the printer has already been connected by Ethernet, tap **Change to Wi-Fi connection.**, and then select **Yes** after checking the message.

4. Select **Push Button Setup (WPS)**.

## Network Settings

5. Hold down the [WPS] button on the access point until the security light flashes.

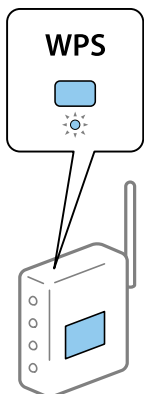

If you do not know where the [WPS] button is, or there are no buttons on the access point, see the documentation provided with your access point for details.

6. Tap **Start Setup** on the printer.

7. Close the screen.

The screen automatically closes after a specific length of time.

**Note:**

*If connection fails, restart the access point, move it closer to the printer, and try again. If it still does not work, print a network connection report and check the solution.*

8. Close the **Network Connection Settings** screen.

### Related Information

- ➔ [“Checking the Network Connection Status” on page 30](#)
- ➔ [“When You Cannot Make Network Settings” on page 189](#)

## Making Wi-Fi Settings by PIN Code Setup (WPS)

You can automatically connect to an access point by using a PIN code. You can use this method to set up if an access point is capable of WPS (Wi-Fi Protected Setup). Use a computer to enter a PIN code into the access point.

1. Tap  on the home screen.

2. Select **Wi-Fi (Recommended)**.

If the printer has already been connected by Ethernet, select **Router**.

3. Tap **Start Setup**.

If the network connection is already set up, the connection details are displayed. Tap **Change Settings** to change the settings.

If the printer has already been connected by Ethernet, tap **Change to Wi-Fi connection.**, and then select **Yes** after checking the message.

4. Select **Others > PIN Code Setup (WPS)**.

## Network Settings

- Use your computer to enter the PIN code (an eight digit number) displayed on the printer's control panel into the access point within two minutes.

**Note:**

See the documentation provided with your access point for details on entering a PIN code.

- Tap **Start Setup** on the printer's control panel.

- Close the screen.

The screen automatically closes after a specific length of time.

**Note:**

If connection fails, restart the access point, move it closer to the printer, and try again. If it still does not work, print a connection report and check the solution.

- Close the **Network Connection Settings** screen.

### Related Information

- ➔ [“Checking the Network Connection Status” on page 30](#)
- ➔ [“When You Cannot Make Network Settings” on page 189](#)

## Making Wi-Fi Direct (Simple AP) Connection Settings

This method allows you to connect the printer directly to devices without an access point. The printer acts as an access point.

 **Important:**

When you connect from a computer or smart device to the printer using the Wi-Fi Direct (Simple AP) connection, the printer is connected to the same Wi-Fi network (SSID) as the computer or smart device and the communication is established between them. Since the computer or smart device is automatically connected to the other connectable Wi-Fi network if the printer is turned off, it is not connected to the previous Wi-Fi network again if the printer is turned on. Connect to the printer's SSID for Wi-Fi Direct (Simple AP) connection from the computer or smart device again. If you do not want to connect every time you turn the printer on or off, we recommend using Wi-Fi network by connecting the printer to an access point.

- Tap  on the home screen.

- Select **Wi-Fi Direct**.

- Tap **Start Setup**.

If you have made Wi-Fi Direct (Simple AP) settings, the detailed connection information is displayed. Go to step 5.

- Tap **Start Setup**.

- Check the SSID and password displayed on the printer's control panel.

On the computer's network connection screen or the smart device's Wi-Fi screen, select the SSID shown on the printer's control panel to connect.

## Network Settings

**Note:**

You can check the connection method on the Web site. To access the Web site, scan the QR code displayed on the printer's control panel using the smart device or enter the URL (<http://epson.sn>) on the computer, and then go to **Setup**.

6. Enter the password displayed on the printer's control panel on the computer or smart device.
7. After the connection is established, tap **OK** on the printer's control panel.
8. Close the **Network Connection Settings** screen.

**Related Information**

- ➔ [“Checking the Network Connection Status” on page 30](#)
- ➔ [“When You Cannot Make Network Settings” on page 189](#)

## Making Advanced Network Settings

You can change the network device name, TCP/IP setup, proxy server and so on. Check your network environment before making changes.

1. Select **Settings** on the home screen.
2. Select **General Settings > Network Settings > Advanced**.
3. Select the menu item for settings, and then select or specify the setting values.

**Related Information**

- ➔ [“Setting Items for Advanced Network Settings” on page 29](#)

## Setting Items for Advanced Network Settings

Select the menu item for settings, and then select or specify the setting values.

 Device Name

You can enter the following characters.

- Character limits: 2 to 15 (you must enter at least 2 characters)
- Usable characters: A to Z, a to z, 0 to 9, -.
- Characters you cannot use at the top: 0 to 9, -.
- Characters you cannot use at the bottom: -

## Network Settings

### TCP/IP

#### Auto

Select when you are using an access point at home or you are allowing the IP address to be acquired automatically by DHCP.

#### Manual

Select when you do not want the printer's IP address to be changed. Enter the addresses for IP Address, Subnet Mask, and Default Gateway, and make DNS Server settings according to your network environment.

When you select **Auto** for the IP address assignment settings, you can select the DNS server settings from **Manual** or **Auto**. If you cannot obtain the DNS server address automatically, select **Manual**, and then enter the primary DNS server and secondary DNS server address directly.

### Proxy Server

#### Do Not Use

Select when you are using the printer in a home network environment.

#### Use

Select when you are using a proxy server in your network environment and you want to set it to the printer. Enter the proxy server address and port number.

### IPv6 Address

#### Enable

Select this when using an IPv6 address.

#### Disable

Select this when using an IPv4 address.

### Link Speed & Duplex

Select an appropriate Ethernet speed and duplex setting. If you select a setting other than Auto, make sure the setting corresponds to the settings on the hub you are using.

#### Auto

#### 10BASE-T Half Duplex

#### 10BASE-T Full Duplex

#### 100BASE-TX Half Duplex

#### 100BASE-TX Full Duplex

---

## Checking the Network Connection Status

You can check the network connection status in the following way.

## Network Icon

You can check the network connection status and strength of the radio wave using the network icon on the printer's home screen.



### Related Information

➔ [“Icons displayed in the LCD Screen” on page 17](#)

## Checking Detailed Network Information from the Control Panel

When your printer is connected to the network, you can also view other network-related information by selecting the network menus you want to check.

1. Select **Settings** on the home screen.
2. Select **General Settings** > **Network Settings** > **Network Status**.
3. To check the information, select the menus that you want to check.
  - Wired LAN/Wi-Fi Status**  
Displays the network information (device name, connection, signal strength, obtain IP address, and so on) for Ethernet or Wi-Fi connections.
  - Wi-Fi Direct Status**  
Displays whether Wi-Fi Direct is enabled or disabled for Wi-Fi Direct connections.
  - Print Status Sheet**  
Prints a network status sheet. The information for Ethernet, Wi-Fi, Wi-Fi Direct, and so on is printed on two or more pages.

### Related Information

➔ [“Printing a Network Status Sheet” on page 38](#)

## Printing a Network Connection Report

You can print a network connection report to check the status between the printer and the access point.

1. Load papers.

## Network Settings

2. Select **Settings** on the home screen.
3. Select **General Settings > Network Settings > Connection Check**.  
The connection check starts.
4. Select **Print Check Report**.
5. Print the network connection report.  
If an error has occurred, check the network connection report, and then follow the printed solutions.
6. Close the screen.

### Related Information

➔ [“Messages and Solutions on the Network Connection Report” on page 32](#)

## Messages and Solutions on the Network Connection Report

Check the messages and error codes on the network connection report, and then follow the solutions.

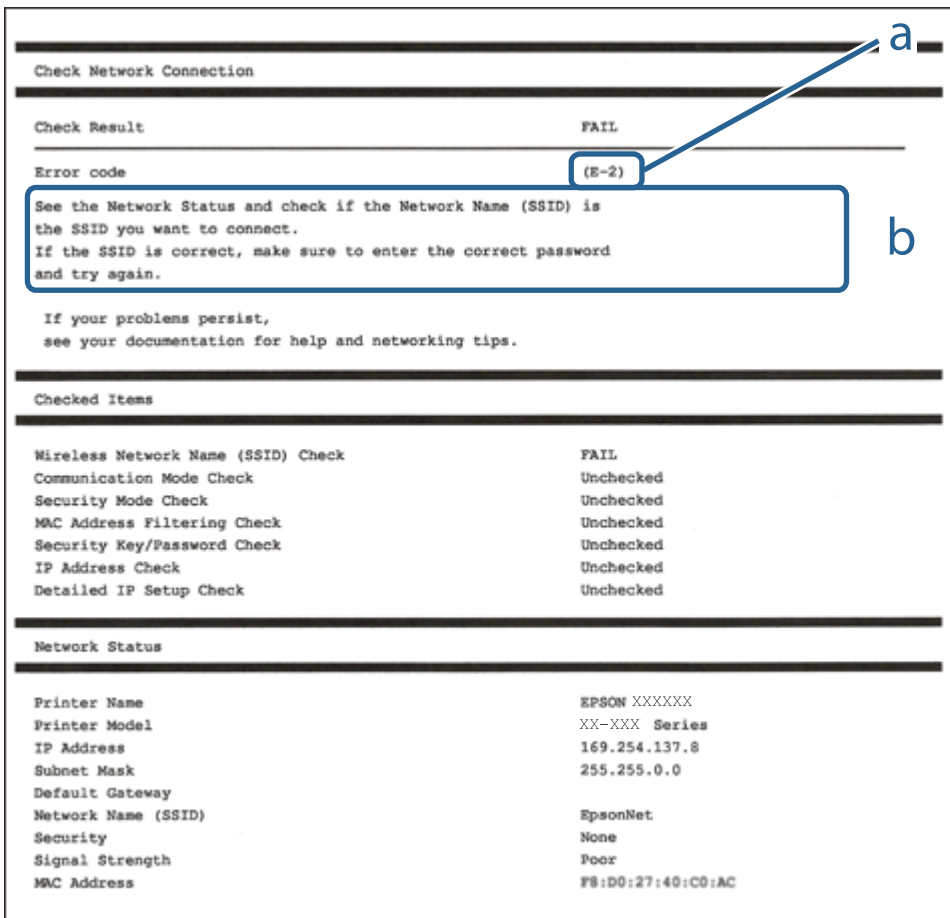

- a. Error code
- b. Messages on the Network Environment



## Network Settings

### Related Information

- ➔ [“E-1” on page 33](#)
- ➔ [“E-2, E-3, E-7” on page 33](#)
- ➔ [“E-5” on page 34](#)
- ➔ [“E-6” on page 35](#)
- ➔ [“E-8” on page 35](#)
- ➔ [“E-9” on page 35](#)
- ➔ [“E-10” on page 36](#)
- ➔ [“E-11” on page 36](#)
- ➔ [“E-12” on page 37](#)
- ➔ [“E-13” on page 37](#)
- ➔ [“Message on the Network Environment” on page 38](#)

### E-1

#### Message:

Confirm that the network cable is connected and network devices such as hub, router, or access point are turned on.

#### Solutions:

- Make sure the Ethernet cable is securely connected to your printer and to your hub or other network device.
- Make sure your hub or other network device is turned on.
- If you want to connect the printer by Wi-Fi, make Wi-Fi settings for the printer again because it is disabled.

### E-2, E-3, E-7

#### Message:

No wireless network names (SSID) found. Confirm that the router/access point is turned on and the wireless network (SSID) is set up correctly. Contact your network administrator for assistance.

No wireless network names (SSID) found. Confirm that the wireless network name (SSID) of the PC you wish to connect is set up correctly. Contact your network administrator for assistance.

Entered security key/password does not match the one set for your router/access point. Confirm security key/password. Contact your network administrator for assistance.

#### Solutions:

- Make sure your access point is turned on.
- Confirm that your computer or device is connected correctly to the access point.
- Turn off the access point. Wait for about 10 seconds, and then turn it on.
- Place the printer closer to your access point and remove any obstacles between them.
- If you have entered the SSID manually, check if it is correct. Check the SSID from the **Network Status** part on the network connection report.

## Network Settings

- If an access point has multiple SSIDs, select the SSID at 2.4 GHz. The printer does not support SSIDs at 5 GHz.
- If you are using push button setup to establish a network connection, make sure your access point supports WPS. You cannot use push button setup if your access point does not support WPS.
- Makes sure your SSID uses only ASCII characters (alphanumeric characters and symbols). The printer cannot display an SSID that contains non-ASCII characters.
- Makes sure you know your SSID and password before connecting to the access point. If you are using an access point with its default settings, the SSID and password are located on a label on the access point. If you do not know your SSID and password, contact the person who set up the access point, or see the documentation provided with the access point.
- If you are connecting to an SSID generated from a tethering smart device, check for the SSID and password in the documentation provided with the smart device.
- If your Wi-Fi connection suddenly disconnects, check for the conditions below. If any of these conditions are applicable, reset your network settings by downloading and running the software from the following website.  
<http://epson.sn> > **Setup**
  - Another smart device was added to the network using push button setup.
  - The Wi-Fi network was set up using any method other than push button setup.

### Related Information

- ➔ [“Connecting to a Computer” on page 23](#)
- ➔ [“Making Wi-Fi Settings from the Printer” on page 24](#)

## E-5

### Message:

Security mode (e.g. WEP, WPA) does not match the current setting of the printer. Confirm security mode. Contact your network administrator for assistance.

### Solutions:

Make sure the access point's security type is set to one of the following. If it is not, change the security type on the access point, and then reset the printer's network settings.

- WEP-64 bit (40 bit)
- WEP-128 bit (104 bit)
- WPA PSK (TKIP/AES)\*
- WPA2 PSK (TKIP/AES)\*
- WPA (TKIP/AES)
- WPA2 (TKIP/AES)

\* WPA PSK is also known as WPA Personal. WPA2 PSK is also known as WPA2 Personal.

## Network Settings

### E-6

#### Message:

MAC address of your printer may be filtered. Check whether your router/access point has restrictions such as MAC address filtering. See the documentation of the router/access point or contact your network administrator for assistance.

#### Solutions:

- Check if MAC address filtering is disabled. If it is enabled, register the printer's MAC address so that it is not filtered. See the documentation provided with the access point for details. You can check the printer's MAC address from the **Network Status** part on the network connection report.
- If your access point is using shared authentication with WEP security, make sure the authentication key and index are correct.
- If the number of connectable devices on the access point is less than the number of network devices that you want to connect, make settings on the access point to increase the number of connectable devices. See the documentation provided with the access point to make settings.

#### Related Information

- ➔ [“Setting Items for Advanced Network Settings” on page 29](#)
- ➔ [“Printing a Network Status Sheet” on page 38](#)

### E-8

#### Message:

Incorrect IP address is assigned to the printer. Confirm IP address setup of the network device (hub, router, or access point). Contact your network administrator for assistance.

#### Solutions:

- Enable DHCP on the access point if the printer's Obtain IP Address setting is set to **Auto**.
- If the printer's Obtain IP Address setting is set to Manual, the IP address you manually set is invalid due to out of range (for example: 0.0.0.0). Set a valid IP address from the printer's control panel or by using Web Config.

#### Related Information

- ➔ [“Setting Items for Advanced Network Settings” on page 29](#)

### E-9

#### Message:

Confirm the connection and network setup of the PC or other device. Connection using the EpsonNet Setup is available. Contact your network administrator for assistance.

#### Solutions:

Check the following.

## Network Settings

- Devices are turned on.
- You can access the Internet and other computers or network devices on the same network from the devices you want to connect to the printer.

If still does not connect your printer and network devices after confirming the above, turn off the access point. Wait for about 10 seconds, and then turn it on. Then reset your network settings by downloading and running the installer from the following website.

<http://epson.sn> > **Setup**

### Related Information

➔ [“Connecting to a Computer” on page 23](#)

## E-10

### Message:

Confirm IP address, subnet mask, and default gateway setup. Connection using the EpsonNet Setup is available. Contact your network administrator for assistance.

### Solutions:

Check the following.

- Other devices on the network are turned on.
- Network addresses (IP address, subnet mask, and default gateway) are correct if you have set the printer's Obtain IP Address to Manual.

Reset the network address if they are incorrect. You can check the IP address, subnet mask, and default gateway from the **Network Status** part on the network connection report.

If DHCP is enabled, change the printer's Obtain IP Address setting to **Auto**. If you want to set the IP address manually, check the printer's IP address from the **Network Status** part on the network connection report, and then select Manual on the network settings screen. Set the subnet mask to [255.255.255.0].

If still does not connect your printer and network devices, turn off the access point. Wait for about 10 seconds, and then turn it on.

### Related Information

➔ [“Setting Items for Advanced Network Settings” on page 29](#)

## E-11

### Message:

Setup is incomplete. Confirm default gateway setup. Connection using the EpsonNet Setup is available. Contact your network administrator for assistance.

### Solutions:

Check the following.

- The default gateway address is correct if you set the printer's TCP/IP Setup setting to Manual.

## Network Settings

- The device that is set as the default gateway is turned on.

Set the correct default gateway address. You can check the default gateway address from the **Network Status** part on the network connection report.

### Related Information

- ➔ [“Setting Items for Advanced Network Settings” on page 29](#)

## E-12

### Message:

Confirm the following -Entered security key/password is correct -Index of the security key/password is set to the first number -IP address, subnet mask, or default gateway setup is correct Contact your network administrator for assistance.

### Solutions:

Check the following.

- Other devices on the network are turned on.
- The network addresses (IP address, subnet mask, and default gateway) are correct if you are entering them manually.
- The network addresses for other devices (subnet mask and default gateway) are the same.
- The IP address does not conflict with other devices.

If still does not connect your printer and network devices after confirming the above, try the following.

- Turn off the access point. Wait for about 10 seconds, and then turn it on.
- Make network settings again using the installer. You can run it from the following website.  
<http://epson.sn> > **Setup**
- You can register several passwords on an access point that uses WEP security type. If several passwords are registered, check if the first registered password is set on the printer.

### Related Information

- ➔ [“Setting Items for Advanced Network Settings” on page 29](#)
- ➔ [“Connecting to a Computer” on page 23](#)

## E-13

### Message:

Confirm the following -Entered security key/password is correct -Index of the security key/password is set to the first number -Connection and network setup of the PC or other device is correct Contact your network administrator for assistance.

### Solutions:

Check the following.

## Network Settings

- Network devices such as an access point, hub, and router are turned on.
- The TCP/IP Setup for network devices has not been set up manually. (If the printer's TCP/IP Setup is set automatically while the TCP/IP Setup for other network devices is performed manually, the printer's network may differ from the network for other devices.)

If it still does not work after checking the above, try the following.

- Turn off the access point. Wait for about 10 seconds, and then turn it on.
- Make network settings on the computer that is on the same network as the printer using the installer. You can run it from the following website.  
<http://epson.sn> > **Setup**
- You can register several passwords on an access point that uses the WEP security type. If several passwords are registered, check if the first registered password is set on the printer.

### Related Information

- ➔ “Setting Items for Advanced Network Settings” on page 29
- ➔ “Connecting to a Computer” on page 23

## Message on the Network Environment

Message	Solution
*Multiple network names (SSID) that match your entered network name (SSID) have been detected. Confirm network name (SSID).	The same SSID may be set on several access points. Check the settings on the access points, and change the SSID.
The Wi-Fi environment needs to be improved. Turn the wireless router off and then turn it on. If the connection does not improve, see the documentation for the wireless router.	After moving the printer closer to the access point and removing any obstacles between them, turn off the access point. Wait for about 10 seconds, and then turn it on. If it still does not connect, see the documentation supplied with the access point.
*No more devices can be connected. Disconnect one of the connected devices if you want to add another one.	You can simultaneously connect up to four computers and smart devices in Wi-Fi Direct (Simple AP) connection. To add another computer or smart device, disconnect one of the connected devices first.

## Printing a Network Status Sheet

You can check the detailed network information by printing it.

1. Load papers.
2. Select **Settings** on the home screen.
3. Select **General Settings** > **Network Settings** > **Network Status**.
4. Select **Print Status Sheet**.
5. Check the message, and then print the network status sheet.

## Network Settings

6. Close the screen.

The screen automatically closes after a specific length of time.

---

## Replacing or Adding New Access Points

If the SSID changes due to the replacement of an access point, or an access point is added and a new network environment is established, re-set the Wi-Fi settings.

### Related Information

- ➔ [“Changing the Connection Method to a Computer” on page 39](#)

---

## Changing the Connection Method to a Computer

Using the installer and re-set up in a different connection method.

- Setting up from the website

Access the following website, and then enter the product name. Go to **Setup**, and then start setting up.

<http://epson.sn>

- Setting up using the software disc (only for the models that come with a software disc and users with computers with disc drives.)

Insert the software disc into the computer, and then follow the on-screen instructions.

### Selecting Change the Connection Methods

Follow the on-screen instructions until the following screen is displayed.

## Network Settings

Select **Change or re-set the connection method** on the Select Software Installation screen, and then click **Next**.

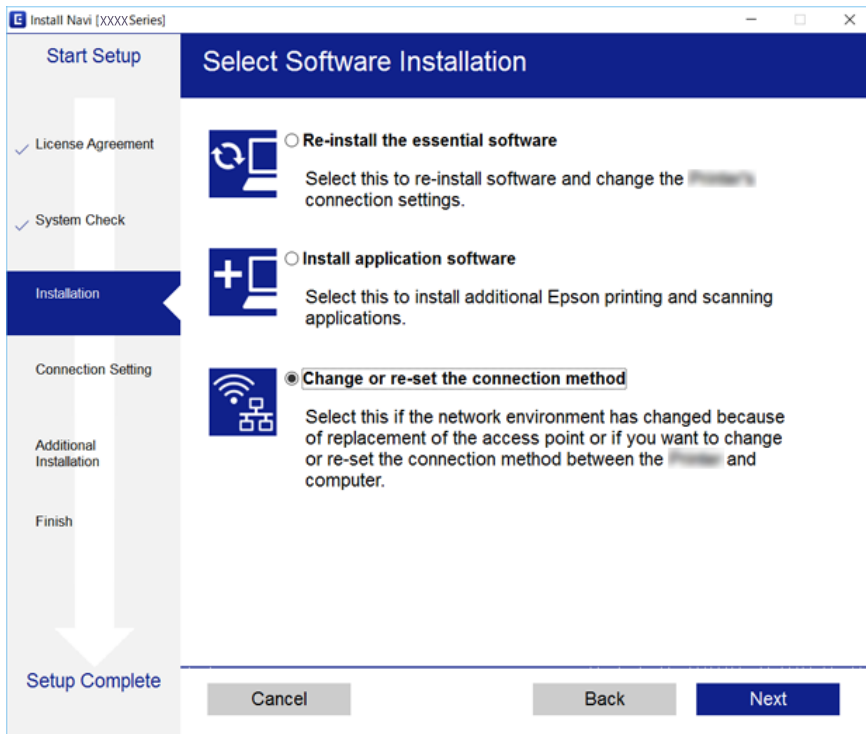

## Changing the Network Connection to Ethernet from the Control Panel

Follow the steps below to change the network connection to Ethernet from Wi-Fi using the control panel.

1. Select **Settings** on the home screen.
2. Select **General Settings > Network Settings > Wired LAN Setup**.
3. Tap **Start Setup**.
4. Check the message, and then close the screen.  
The screen automatically closes after a specific length of time.
5. Connect the printer to a router using an Ethernet cable.

## Disabling Wi-Fi from the Control Panel

When Wi-Fi is disabled, the Wi-Fi connection is disconnected.

1. Tap  on the home screen.



## Network Settings

2. Select **Wi-Fi (Recommended)**.  
The network status is displayed.
3. Tap **Change Settings**.
4. Select **Others > Disable Wi-Fi**.
5. Check the message, and then start setup.
6. When a completion message is displayed, close the screen.  
The screen automatically closes after a specific length of time.
7. Close the network connection settings screen.

---

## Disconnecting Wi-Fi Direct (Simple AP) Connection from the Control Panel

**Note:**

When Wi-Fi Direct (Simple AP) connection disabled, all computers and smart devices connected to the printer in Wi-Fi Direct (Simple AP) connection are disconnected. If you want to disconnect a specific device, disconnect from the device instead of the printer.

1. Tap  on the home screen.
2. Select **Wi-Fi Direct**.  
The Wi-Fi Direct information is displayed.
3. Tap **Change Settings**.
4. Select **Disable Wi-Fi Direct**.
5. Tap the **Disable the settings**.
6. When a completion message is displayed, close the screen.  
The screen automatically closes after a specific length of time.
7. Close the **Network Connection Settings** screen.

---

## Restoring the Network Settings from the Control Panel

You can restore all network settings to their defaults.

1. Select **Settings** on the home screen.
2. Select **Restore Default Settings > Network Settings**.

## Network Settings

3. Check the message, and then select **Yes**.
4. When a completion message is displayed, close the screen.  
The screen automatically closes after a specific length of time.

# Preparing the Printer

## Loading Papers

### Available Paper and Capacities

Epson recommends using genuine Epson paper to ensure high-quality printouts.

#### Genuine Epson Paper

Media Name	Size	Loading Capacity (Sheets)	2-Sided Printing	Borderless Printing
Epson Bright White Ink Jet Paper	A4	120	Auto, Manual*1	✓
Epson Ultra Glossy Photo Paper	A4, 13×18 cm (5×7 in.), 10×15 cm (4×6 in.)	20*2	-	✓
Epson Premium Glossy Photo Paper	A4, 13×18 cm (5×7 in.), 16:9 wide size (102×181 mm), 10×15 cm (4×6 in.)	20*2	-	✓
Epson Premium Semigloss Photo Paper	A4, 10×15 cm (4×6 in.)	20*2	-	✓
Epson Photo Paper Glossy	A4, 13×18 cm (5×7 in.), 10×15 cm (4×6 in.)	20*2	-	✓
Epson Matte Paper-Heavyweight	A4	20	-	✓
Epson Double-Sided Matte Paper	A4	1	Manual	✓
Epson Photo Quality Ink Jet Paper	A4	100	-	✓

\*1 You can load up to 30 sheets for paper with one side already printed.

\*2 Load one sheet of paper at a time if the paper does not feed correctly or if the printout has uneven colors or smears.

#### Note:

- The availability of paper varies by location. For the latest information on paper available in your area, contact Epson support.
- When printing on genuine Epson paper at a user defined size, only **Standard** or **Normal** print quality settings are available. Although some printer drivers allow you to select a better print quality, the printouts are printed using **Standard** or **Normal**.

## Preparing the Printer

### Commercially Available Paper

Media Name	Size	Loading Capacity (Sheets or Envelopes)	2-Sided Printing	Borderless Printing
Plain paper	Letter, A4	150	Auto, Manual*2	✓
Copy paper	B5, 16K (195×270 mm )	150	Auto, Manual*2	-
	A5, A6, B6	150	Manual*2	-
	Legal, 8.5×13 in.	1	Manual	-
	User Defined*1 (mm) 89×127 to 182×257 215.9×297 to 1200	1	Manual	-
	User Defined*1 (mm) 182×257 to 215.9×297	1	Auto, Manual	-
Envelope	Envelope #10, Envelope DL, Envelope C6	10	-	-

\*1 Only printing from computer or smart device is available.

\*2 You can load up to 30 sheets for paper with one side already printed.

### Paper Handling Precautions

- Read the instruction sheets supplied with the paper.
- Fan and align the edges of the paper before loading. Do not fan or curl photo paper. Doing so may damage the printable side.

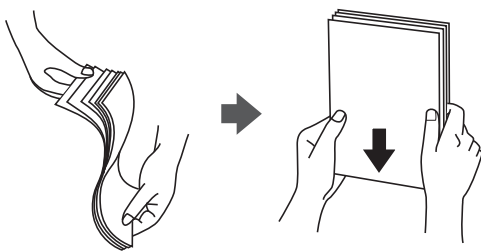

- If the paper is curled, flatten it or curl it slightly in the opposite direction before loading. Printing on curled paper may cause paper jams and smears on the printout.

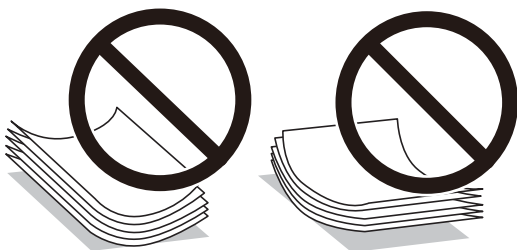

## Preparing the Printer

- ❑ Do not use paper that is wavy, torn, cut, folded, damp, too thick, too thin, or paper that has stickers stuck to it. Using these types of paper causes paper jams and smears on the printout.
- ❑ Make sure you are using long-grain paper. If you are not sure what type of paper you are using, check the paper packaging or contact the manufacturer to confirm the paper specifications.

### Related Information

➔ [“Printer Specifications” on page 212](#)

## Loading Paper in the Paper Cassette

1. Open the front cover until it clicks.

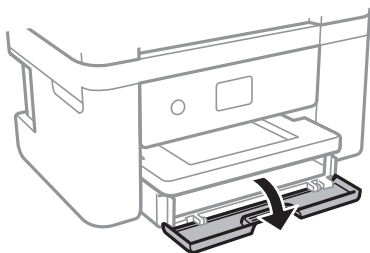

2. Check that the printer is not operating, and then slide out the paper cassette.

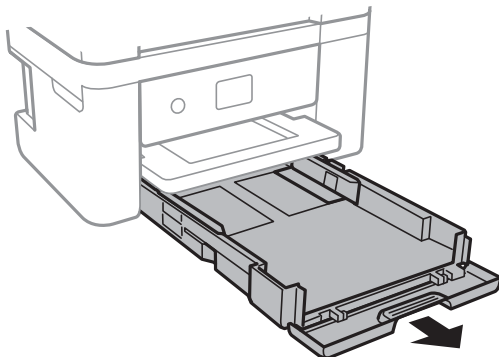

**Important:**

*The paper cassette cannot be removed.*

## Preparing the Printer

- Slide the edge guides to their maximum position.

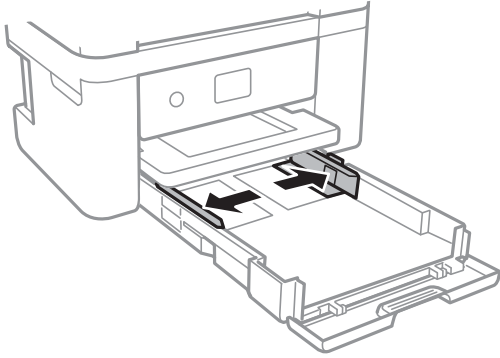

- With the printable side facing down, load paper until it touches the back of the paper cassette.

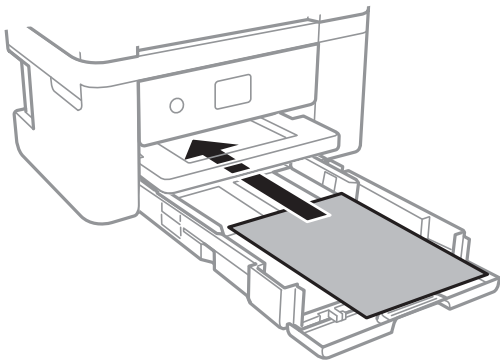

**!** *Important:*

*Do not load more than the maximum number of sheets specified for the paper.*

- ❑ 8.5 x 13 in.

Load paper using the line.

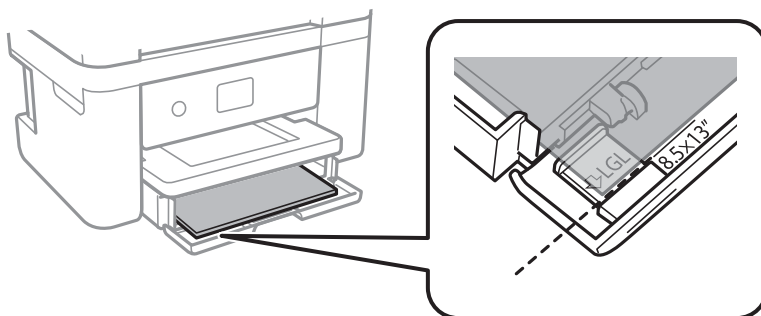

## Preparing the Printer

### ❑ Legal

Pull out the legal paper guide and load paper using the line.

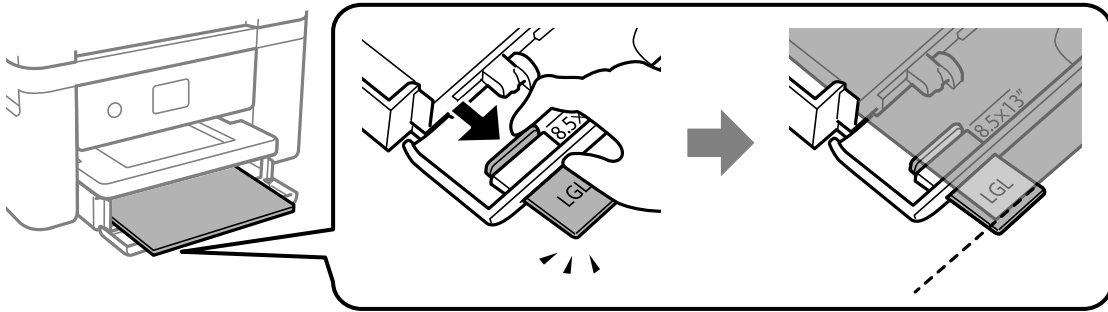

5. Slide the edge guides to the edges of the paper.

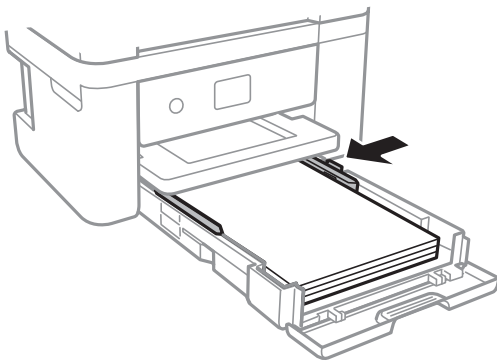

6. Insert the paper cassette gently.

7. On the control panel, set the size and type of the paper you loaded in the paper cassette. If your paper size is not displayed, select **User-Defined**.

**Note:**

You can also display the paper size and paper type settings screen by selecting **Settings > General Settings > Printer Settings > Paper Source Settings > Paper Setting**.

8. Slide out the output tray.

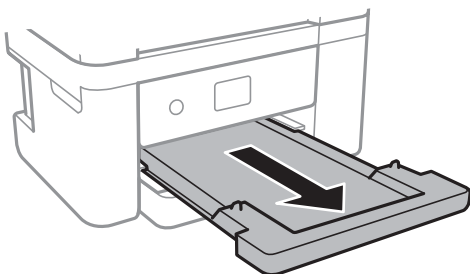

### Related Information

- ➔ [“Paper Handling Precautions” on page 44](#)
- ➔ [“Available Paper and Capacities” on page 43](#)
- ➔ [“List of Paper Type” on page 48](#)

## Preparing the Printer

➔ [“Loading Envelopes and Precautions” on page 48](#)

### Loading Envelopes and Precautions

Load envelopes with the flap facing up, and then slide the edge guides to the edges of the envelopes.

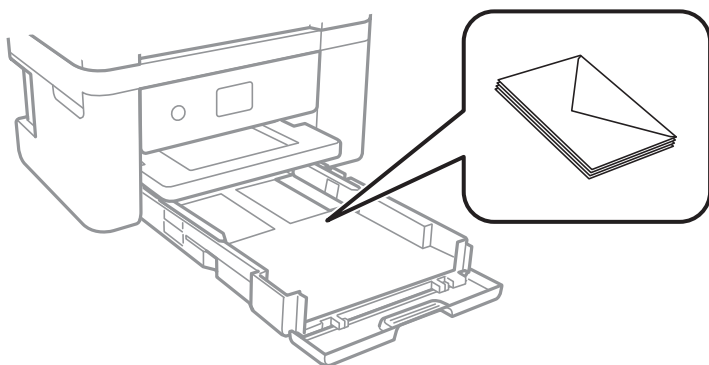

- Fan and align the edges of the envelopes before loading. When the stacked envelopes are puffed up with air, press them down to flatten them before loading.



- Do not use envelopes that are curled or folded. Using these envelopes causes paper jams and smears on the printout.
- Do not use envelopes with adhesive surfaces on the flaps or window envelopes.
- Avoid using envelopes that are too thin, as they may curl during printing.

#### Related Information

- ➔ [“Available Paper and Capacities” on page 43](#)
- ➔ [“Loading Paper in the Paper Cassette” on page 45](#)

### List of Paper Type

To obtain optimum printing results, select the paper type that suits the paper.

Media Name	Media Type	
	Control Panel	Printer Driver
Epson Bright White Ink Jet Paper	Plain paper	Plain paper
Epson Ultra Glossy Photo Paper	Ultra Glossy	Epson Ultra Glossy
Epson Premium Glossy Photo Paper	Prem. Glossy	Epson Premium Glossy



## Preparing the Printer

Media Name	Media Type	
	Control Panel	Printer Driver
Epson Premium Semigloss Photo Paper	Prem. Semigloss	Epson Premium Semigloss
Epson Photo Paper Glossy	Glossy	Photo Paper Glossy
Epson Matte Paper-Heavyweight Epson Double-Sided Matte Paper Epson Photo Quality Ink Jet Paper	Matte	Epson Matte

## Placing Originals

Place originals on the scanner glass or the ADF.

You can scan multiple originals at the same time with the ADF.

## Available Originals for the ADF

Available Paper Sizes	A4, Letter, 8.5x13 in., Legal
Paper Type	Plain paper
Paper Thickness (Weight of Paper)	64 to 95 g/m <sup>2</sup>
Loading Capacity	A4, Letter: 30 sheets or 3.3 mm 8.5x13 in., Legal: 10 sheets

Even when the original meets the specifications for media that can be placed in the ADF, it may not feed from the ADF or the scan quality may decline depending on the paper properties or quality.



**Important:**

*Do not feed photographs or valuable original artwork into the ADF. Misfeeding may wrinkle or damage the original. Scan these documents on the scanner glass instead.*

To prevent paper jams, avoid placing the following originals in the ADF. For these types, use the scanner glass.

- Originals that are torn, folded, wrinkled, deteriorated, or curled
- Originals with binder holes
- Originals held together with tape, staples, paper clips etc.
- Originals that have stickers or labels stuck to them
- Originals that are cut irregularly or not right angled
- Originals that are bound
- OHPs, thermal transfer paper, or carbon backs

## Preparing the Printer

### Placing Originals on the ADF

1. Align the edges of the originals.
2. Open the ADF document support and extend the ADF output tray extension.

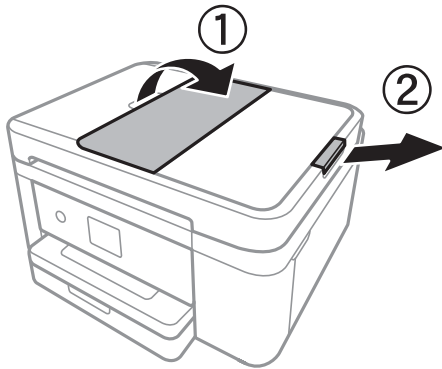

3. Pinch and slide out the ADF edge guide.

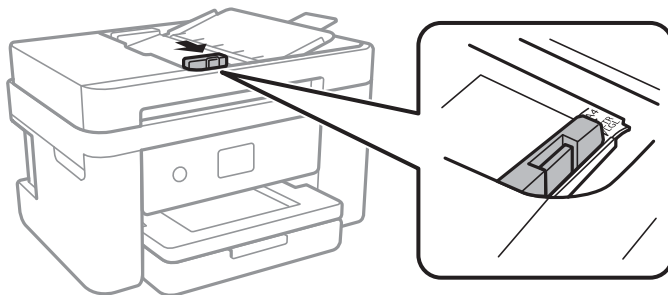

4. Place the originals face-up in the ADF, and then slide the ADF edge guide to the edge of the originals.

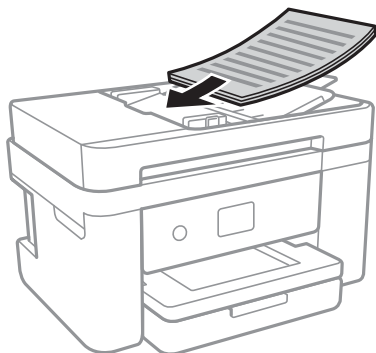

## Preparing the Printer

**!** **Important:**

- ❑ Do not load originals above the line indicated by the triangle symbol on the ADF.

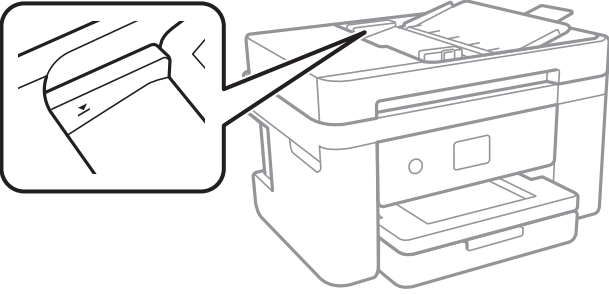

- ❑ Do not add originals while scanning.

### Related Information

➔ [“Available Originals for the ADF” on page 49](#)

## Placing Originals on the ADF for 2-up Copying

Place the originals in the direction shown in the illustration, and then select the orientation setting.

- ❑ Portrait originals: Select **Portrait** on the control panel as described below.

**Copy > Advanced Settings > Original Orientation > Portrait**

Place the originals on the ADF in the direction of the arrow.



- ❑ Landscape originals: Select **Landscape** on the control panel as described below.

**Copy > Advanced Settings > Original Orientation > Landscape**

Place the originals on the ADF in the direction of the arrow.



## Placing Originals on the Scanner Glass

**!** **Caution:**

Be careful not to trap your hand or fingers when opening or closing the document cover. Otherwise you may be injured.

## Preparing the Printer

**!** *Important:*

*When placing bulky originals such as books, prevent exterior light from shining directly onto the scanner glass.*

1. Open the document cover.

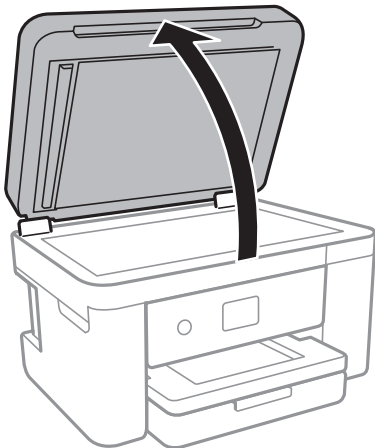

2. Remove any dust or stains on the scanner glass.
3. Place the original face-down and slide it to the corner mark.

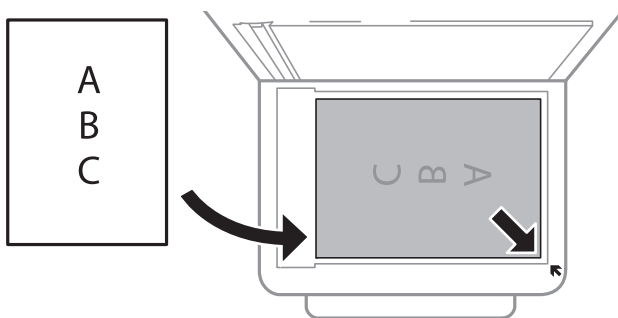

**Note:**

- A range of 1.5 mm from the bottom edge and right edge of the scanner glass is not scanned.
- When originals are placed in the ADF and on the scanner glass, priority is given to the originals in the ADF.

4. Close the cover gently.

**!** *Important:*

*Do not apply too much force to the scanner glass or the document cover. Otherwise, they may be damaged.*

5. Remove the originals after scanning.

**Note:**

*If you leave the originals on the scanner glass for a long time, they may stick to the surface of the glass.*

## Preparing the Printer

### Placing an ID Card for Copying

Place an ID card 5 mm away from the corner mark of the scanner glass.

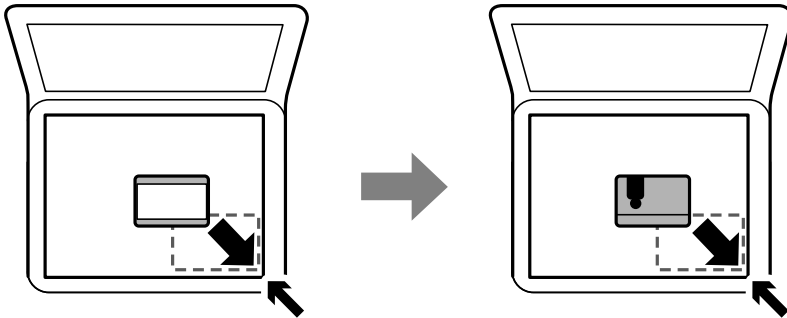

---

## Managing Contacts

Registering a contacts list allows you to easily enter destinations. You can register up to 100 entries, and you can use the contacts list when you enter a fax number.

### Registering or Editing Contacts

1. Select **Fax** on the home screen.
2. Select **Contacts**.
3. Do one of the following.
  - To register a new contact, select **Add Entry**, and then select **Add Contact**.
  - To edit a contact, select **>** on the target contact, and then select **Edit**.
  - To delete a contact, select **>** on the target contact, and then select **Delete**, and then select **Yes**. You do not have to perform following procedures.
4. Make the necessary settings.

**Note:**

*When entering a fax number, enter an external access code at the beginning of the fax number if your phone system is PBX and you need the access code to get an outside line. If the access code has been set in the **Line Type** setting, enter a hash (#) instead of the actual access code. To add a pause (pause for three seconds) during dialing, enter a hyphen (-).*

5. Tap **OK**.

#### Related Information

➔ [“Entering Characters” on page 20](#)

### Registering or Editing Grouped Contacts

Adding contacts to a group allows you to send a fax to multiple destinations at the same time.

## Preparing the Printer

1. Select **Fax** on the home screen.
2. Select **Contacts**.
3. Do one of the following.
  - To register a new grouped contacts, select **Add Entry** and then select **Add Group**.
  - To edit a grouped contacts, select **>** on the target grouped contacts, and then select **Edit**.
  - To delete a grouped contacts, select **>** on the target grouped contacts and then select **Delete**, and then select **Yes**. You do not have to perform following procedures.
4. Enter or edit the **Group Name** and the **Index Word**, and then select **Contact(s) Added to the Group (Required)**.
5. Select the contacts that you want to register in the group, and then tap **Close**.

**Note:**

  - You can register up to 99 contacts.
  - To deselect a contact, tap it again.
6. Tap **OK**.

### Related Information

- ➔ [“Entering Characters” on page 20](#)

## Register Contacts on a Computer

Using Web Config, you can create a contact list on your computer and import it to the printer.

1. Access Web Config.
2. Select **Advanced Settings** from the list at the top right of the window.
3. Select **Contacts**.
4. Select the number that you want to register, and then click **Edit**.
5. Enter **Name**, **Index Word**, **Fax Number**, and **Fax Speed**.
6. Click **Apply**.

### Related Information

- ➔ [“Application for Configuring Printer Operations \(Web Config\)” on page 168](#)
- ➔ [“Running Web Config on a Web Browser” on page 168](#)

## Preparing the Printer

### Destination Setting Items

Items	Settings and Explanation
Name	Enter a name displayed in the contacts in 30 characters or less in Unicode (UTF-8). If you do not specify this, leave it blank.
Index Word	Enter words to search in 30 characters or less in Unicode (UTF-8). If you do not specify this, leave it blank.
Type	This item is fixed as <b>Fax</b> . You cannot change this setting.
Fax Number	Enter between 1 and 64 characters using 0-9 - * # and space.
Fax Speed	Select a communication speed for a destination.

### Registering Destinations as a Group

1. Access Web Config.
2. Select **Advanced Settings** from the list at the top right of the window.
3. Select **Contacts**.
4. Select the number that you want to register, and then click **Edit**.
5. Enter a **Name** and **Index Word**.
6. Select a group from **Type**.
7. Click **Select** for **Contact(s) for Group**.  
The available destinations are displayed.
8. Select the destination that you want to register to the group, and then click **Select**.  
*Note:*  
*Destinations can be registered to multiple groups.*
9. Click **Apply**.

#### Related Information

- ➔ [“Application for Configuring Printer Operations \(Web Config\)” on page 168](#)
- ➔ [“Running Web Config on a Web Browser” on page 168](#)

---

## Menu Options for Settings

Select **Settings** on the home screen of the printer to make various settings.

## Menu Options for General Settings

Select the menus on the control panel as described below.

### Settings > General Settings

#### Basic Settings

Select the menus on the control panel as described below.

### Settings > General Settings > Basic Settings

#### LCD Brightness:

Adjust the brightness of the LCD screen.

#### Sound:

Adjust the volume and select the type of the sound.

#### Sleep Timer:

Adjust the time period to enter a sleep mode (energy saving mode) when the printer has not performed any operations. The LCD screen turns black when the setting time passes.

#### Power Off Timer:

Your product may have this feature or the **Power Off Settings** feature depending on the location of purchase.

Select this setting to turn the printer off automatically when it is not used for a specified period of time. You can adjust the time before power management is applied. Any increase will affect the product's energy efficiency. Please consider the environment before making any change.

#### Power Off Settings:

Your product may have this feature or the **Power Off Timer** feature depending on the location of purchase.

##### Power Off If Inactive

Select this setting to turn the printer off automatically if it is not used for a specified period of time. Any increase will affect the product's energy efficiency. Please consider the environment before making any change.

##### Power Off If Disconnected

Select this setting to turn the printer off after 30 minutes when all network ports including the LINE port are disconnected. This feature may not be available depending on your region.

#### Date/Time Settings:

##### Date/Time

Enter the current date and time.

##### Daylight Saving Time

Select the summer time setting that applies to your area.

##### Time Difference

Enter the time difference between your local time and UTC (Coordinated Universal Time).



## Preparing the Printer

### Country/Region:

Select the country or region in which you are using your printer. If you change the country or region, your fax settings return to their defaults and you must select them again.

### Language:

Select the language used on the LCD screen.

### Operation Time Out:

Select **On** to return to the initial screen when no operations have been performed for the specified time.

### Keyboard:

Change the layout of the keyboard on the LCD screen.

### Related Information

➔ [“Saving Power - Control Panel” on page 63](#)

➔ [“Entering Characters” on page 20](#)

## Printer Settings

Select the menus on the control panel as described below.

### Settings > General Settings > Printer Settings

#### Paper Source Settings:

##### Paper Setting:

Select the paper size and paper type you loaded in the paper source. You can make **Favorite Paper Settings** in paper size and paper type.

##### A4/Letter Auto Switching:

Select **On** to feed paper from the paper source set as A4 size when there is no paper source set as Letter, or feed from the paper source set as Letter size when there is no paper source set as A4.

##### Error Notice:

Select **On** to display an error message when the selected paper size or type does not match the loaded paper.

##### Paper Setup Auto Display:

Select **On** to display the **Paper Setting** screen when loading paper in the paper source. If you disable this feature, you cannot print from an iPhone or iPad using AirPrint.

#### Universal Print Settings:

These print settings are applied when you print by an external device without using the printer driver.

##### Top Offset:

Adjust the top margin of the paper.

## Preparing the Printer

### Left Offset:

Adjust the left margin of the paper.

### Top Offset in Back:

Adjust the top margin for the back of the page when performing 2-sided printing.

### Left Offset in Back:

Adjust the left margin for the back margin of the page when performing 2-sided printing.

### Check Paper Width:

Select **On** to check the paper width before printing. This prevents printing beyond the edges of the paper when the paper size settings are incorrect, but may reduce the printing speed.

### Skip Blank Page:

Skips blank pages in the print data automatically.

### Auto Error Solver:

Select an action to perform when a 2-sided printing error or a memory full error occurs.

#### On

Displays a warning and prints in single-sided mode when a 2-sided printing error occurs, or prints only what the printer could process when a memory full error occurs.

#### Off

Displays an error message and cancels printing.

### Quiet Mode:

Select **On** to reduce noise during printing, however, this may lower the print speed. Depending on the paper type and print quality settings you selected, there may be no difference in the printer's noise level.

### Ink Drying Time:

Select the ink drying time you want to use when performing 2-sided printing. The printer prints the other side after printing one side. If your printout is smeared, increase the time setting.

### PC Connection via USB:

Select **Enable** to allow a computer to access the printer when connected by USB. When **Disable** is selected, printing and scanning that is not sent over a network connection is restricted.

## Network Settings

Select the menus on the control panel as described below.

### **Settings > General Settings > Network Settings**

#### Wi-Fi Setup:

Set up or change wireless network settings. Choose the connection method from the following and then follow the instructions on the LCD panel.

#### Wi-Fi (Recommended)

## Preparing the Printer

- Wi-Fi Direct

### Wired LAN Setup:

Set up or change a network connection that uses a LAN cable and router. When this is being used, Wi-Fi connections are disabled.

### Network Status:

Displays or prints the current network settings.

- Wired LAN/Wi-Fi Status
- Wi-Fi Direct Status
- Print Status Sheet

### Connection Check:

Checks the current network connection and prints a report. If there are any problems with the connection, see the report to solve the problem.

### Advanced:

Make the following detailed settings.

- Device Name
- TCP/IP
- Proxy Server
- IPv6 Address
- Link Speed & Duplex

### Related Information

- ➔ [“Making Wi-Fi Settings Manually” on page 25](#)
- ➔ [“Making Wi-Fi Settings by Push Button Setup \(WPS\)” on page 26](#)
- ➔ [“Making Wi-Fi Settings by PIN Code Setup \(WPS\)” on page 27](#)
- ➔ [“Making Wi-Fi Direct \(Simple AP\) Connection Settings” on page 28](#)
- ➔ [“Printing a Network Status Sheet” on page 38](#)
- ➔ [“Checking the Network Connection Status” on page 30](#)
- ➔ [“Changing the Network Connection to Ethernet from the Control Panel” on page 40](#)
- ➔ [“Making Advanced Network Settings” on page 29](#)

## Web Service Settings

Select the menus on the control panel as described below.

### Settings > General Settings > Web Service Settings

#### Epson Connect Services:

Displays whether the printer is registered and connected to Epson Connect.

You can register to the service by selecting **Register** and follow the instructions.

When you have registered, you can change the following settings.

## Preparing the Printer

- Suspend/Resume
- Unregister

For details, see the following web site.

<https://www.epsonconnect.com/>

<http://www.epsonconnect.eu> (Europe only)

### Google Cloud Print Services:

Displays whether the printer is registered and connected to Google Cloud Print services.

When you have registered, you can change the following settings.

- Enable/Disable
- Unregister

For details on registering to Google Cloud Print services, see the following web site.

<https://www.epsonconnect.com/>

<http://www.epsonconnect.eu> (Europe only)

### Related Information

➔ [“Printing Using a Network Service” on page 179](#)

## Menu Options for Supply Status

Select the menu on the control panel as described below.

### Settings > Supply Status

Displays the approximate level of the ink and service life of the maintenance box.

When the ! mark is displayed, ink is running low or the maintenance box is nearly full. When the X mark is displayed, you need to replace the item as ink is expended or the maintenance box is full.

You can replace ink cartridges or print supply status information from this screen.

## Menu Options for Maintenance

Select the menus on the control panel as described below.

### Settings > Maintenance

#### Print Head Nozzle Check:

Select this feature to check if the print head nozzles are clogged. The printer prints a nozzle check pattern.

#### Print Head Cleaning:

Select this feature to clean clogged nozzles in the print head.

## Preparing the Printer

### Print Head Alignment:

Use this feature to adjust the print head to improve print quality.

Ruled Line Alignment

Select this feature to align vertical lines.

Vertical Alignment

Select this feature if your printouts look blurry or text and lines are misaligned.

Horizontal Alignment

Select this feature if horizontal banding appears at regular intervals in your printouts.

### Ink Cartridge Replacement:

Use this feature to replace the ink cartridges before the ink is expended.

### Paper Guide Cleaning:

Select this feature if there are ink stains on the internal rollers. The printer feeds paper to clean the internal rollers.

### Related Information

- ➔ [“Checking and Cleaning the Print Head” on page 158](#)
- ➔ [“Aligning the Print Head” on page 159](#)
- ➔ [“Replacing Ink Cartridges” on page 153](#)
- ➔ [“Cleaning the Paper Path for Ink Smears” on page 161](#)

## Menu Options for Print Status Sheet

Select the menus on the control panel as described below.

### Settings > Print Status Sheet

#### Configuration Status Sheet:

Print information sheets showing the current printer status and settings.

#### Supply Status Sheet:

Print information sheets showing the status of consumables.

#### Usage History Sheet:

Print information sheets showing the usage history of the printer.

## Menu Options for Print Counter

Select the menus on the control panel as described below.

### Settings > Print Counter

Displays the total number of prints, B&W prints, and color prints from the time you purchased the printer.

## Menu Options for User Settings

Select the menus on the control panel as described below.

### Settings > User Settings

You can change the default settings of the following menus.

- Copy
- Scan to Computer
- Scan to Cloud
- Fax

## Menu Options for Restore Default Settings

Select the menus on the control panel as described below.

### Settings > Restore Default Settings

Resets the following menus to their defaults.

- Network Settings
- Copy Settings
- Scan Settings
- Fax Settings
- Clear All Data and Settings

## Menu Options for Firmware Update

Select the menus on the control panel as described below.

### Settings > Firmware Update

Update:

Check if the latest version of the firmware has been uploaded to the network server. If an update is available, you can select whether or not to start updating.

Notification:

Select **On** to receive a notification if a firmware update is available.

---

## Saving Power

The printer enters sleep mode or turns off automatically if no operations are performed for a set period. You can adjust the time before power management is applied. Any increase will affect the product's energy efficiency. Please consider the environment before making any change.

## Preparing the Printer

Depending on the location of purchase, the printer may have a feature that turns it off automatically if it is not connected to the network for 30 minutes.

### Saving Power - Control Panel

1. Select **Settings** on the home screen.
2. Select **General Settings** > **Basic Settings**.
3. Do one of the following.
  - Select **Sleep Timer** or **Power Off Settings** > **Power Off If Inactive** or **Power Off If Disconnected**, and then make settings.
  - Select **Sleep Timer** or **Power Off Timer**, and then make settings.

**Note:**

*Your product may have the **Power Off Settings** or **Power Off Timer** feature depending on the location of purchase.*

# Printing

---

## Printing from the Printer Driver on Windows

### Accessing the Printer Driver

When accessing the printer driver from the computer's control panel, the settings are applied to all of the applications.

#### Accessing the printer driver from the control panel

Windows 10/Windows Server 2016

Right-click the start button or press and hold it, and then select **Control Panel > View devices and printers in Hardware and Sound**. Right-click on your printer, or press and hold it and then select **Printing preferences**.

Windows 8.1/Windows 8/Windows Server 2012 R2/Windows Server 2012

Select **Desktop > Settings > Control Panel > View devices and printers in Hardware and Sound**. Right-click on your printer, or press and hold it and then select **Printing preferences**.

Windows 7/Windows Server 2008 R2

Click the start button, and select **Control Panel > View devices and printers in Hardware and Sound**. Right-click on your printer and select **Printing preferences**.

Windows Vista/Windows Server 2008

Click the start button, and select **Control Panel > Printers in Hardware and Sound**. Right-click on your printer and select **Select printing preferences**.

Windows XP/Windows Server 2003 R2/Windows Server 2003

Click the start button, and select **Control Panel > Printers and Other Hardware > Printers and Faxes**. Right-click on your printer and select **Printing preferences**.

#### Accessing the printer driver from the printer icon on the task bar

The printer icon on the desktop task bar is a shortcut icon allowing you to quickly access the printer driver.

If you click the printer icon and select **Printer Settings**, you can access the same printer settings window as the one displayed from the control panel. If you double-click this icon, you can check the status of the printer.

**Note:**

*If the printer icon is not displayed on the task bar, access the printer driver window, click **Monitoring Preferences** on the **Maintenance** tab, and then select **Register the shortcut icon to the taskbar**.*

### Printing Basics

**Note:**

*Operations may differ depending on the application. See the application's help for details.*

1. Open the file you want to print.

Load paper in the printer if it has not already been loaded.



## Printing

2. Select **Print** or **Page Setup** from the **File** menu.
3. Select your printer.
4. Select **Preferences** or **Properties** to access the printer driver window.

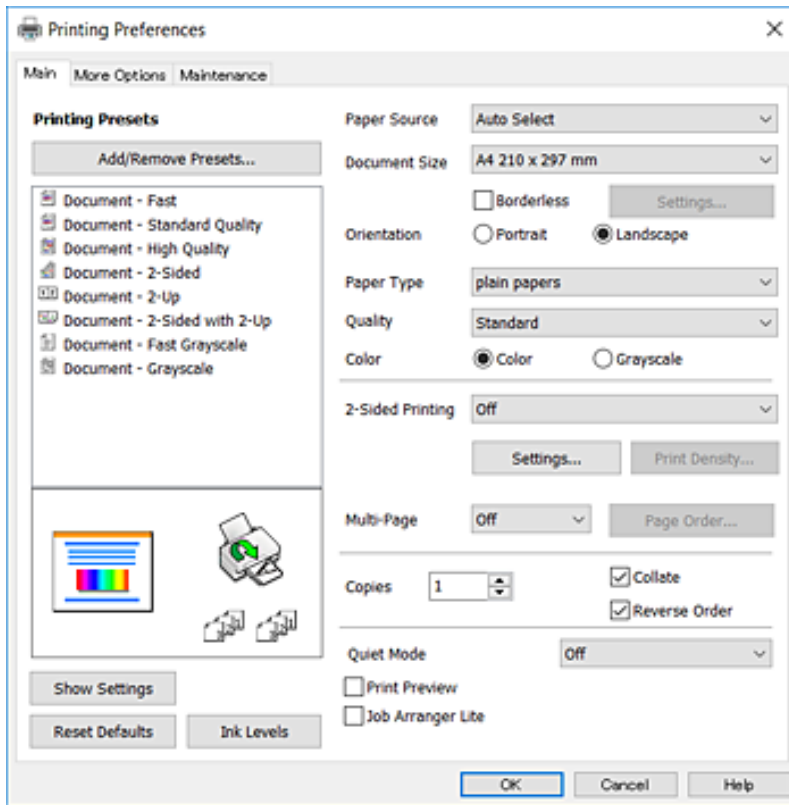

5. Change the settings as necessary.  
See the menu options for the printer driver for details.

**Note:**

- You can also see the online help for explanations of the setting items. Right-clicking an item displays **Help**.
- When you select **Print Preview**, you can see a preview of your document before printing.

6. Click **OK** to close the printer driver window.
7. Click **Print**.

**Note:**

When you select **Print Preview**, a preview window is displayed. To change the settings, click **Cancel**, and then repeat the procedure from step 2.

### Related Information

- ➔ “Available Paper and Capacities” on page 43
- ➔ “Loading Paper in the Paper Cassette” on page 45
- ➔ “List of Paper Type” on page 48
- ➔ “Main Tab” on page 80

## Printing

### Printing on 2-Sides

You can print on both sides of the paper. You can also print a booklet that can be created by re-ordering the pages and folding the printout.

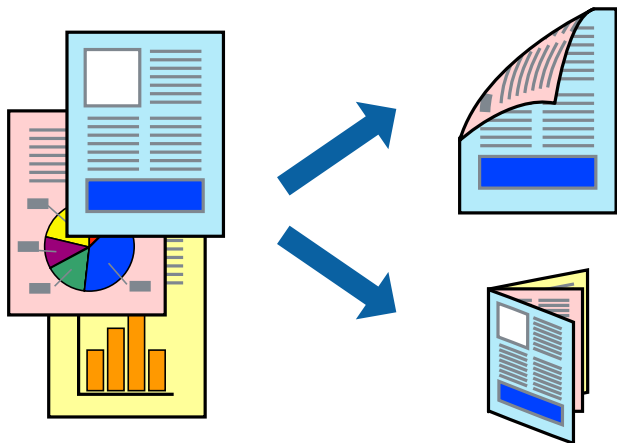

**Note:**

- This feature is not available for borderless printing.
- You can use automatic and manual 2-sided printing. During manual 2-sided printing, flip the paper over to print on the other side when the printer has finished printing the first side.
- If you do not use paper that is suitable for 2-sided printing, the print quality may decline and paper jams may occur.
- Depending on the paper and the data, ink may bleed through to the other side of the paper.

**Related Information**

- ➔ [“Available Paper and Capacities” on page 43](#)

### Print Settings

Manual 2-sided printing is available when EPSON Status Monitor 3 is enabled. However, it may not be available when the printer is accessed over a network or is used as a shared printer.

**Note:**

To enable EPSON Status Monitor 3, click **Extended Settings** on the **Maintenance** tab, and then select **Enable EPSON Status Monitor 3**.

1. On the printer driver's **Main** tab, select an option from **2-Sided Printing**.
2. Click **Settings**, make the appropriate settings, and then click **OK**.

Make settings for **Print Density** if necessary. This setting is not available when you select manual 2-sided printing.

**Note:**

- To print a folded booklet, select **Booklet**.
- When setting **Print Density**, you can adjust print density according to the document type.
- Printing may be slow depending on the combination of options selected for **Select Document Type** in the **Print Density Adjustment** window and for **Quality** on the **Main** tab.

## Printing

### 3. Click **Print**.

For manual 2-sided printing, when the first side has finished printing, a pop-up window is displayed on the computer. Follow the on-screen instructions.

#### Related Information

- ➔ “Printing Basics” on page 64
- ➔ “Main Tab” on page 80

## Printing Several Pages on One Sheet

You can print two or four pages of data on a single sheet of paper.

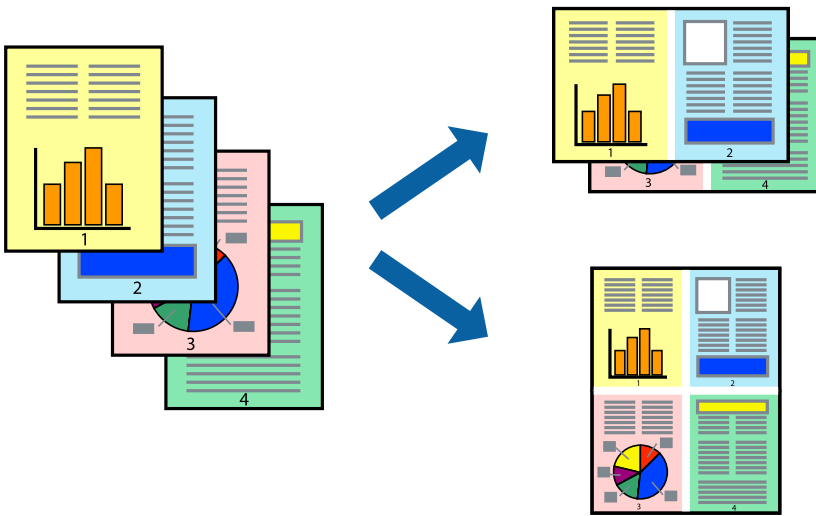

## Print Settings

On the printer driver's **Main** tab, select **2-Up** or **4-Up** as the **Multi-Page** setting.

#### Note:

*This feature is not available for borderless printing.*

#### Related Information

- ➔ “Printing Basics” on page 64
- ➔ “Main Tab” on page 80

## Printing

### Printing and Stacking in Page Order (Reverse Order Printing)

You can print from the last page so that the documents are stacked in page order.

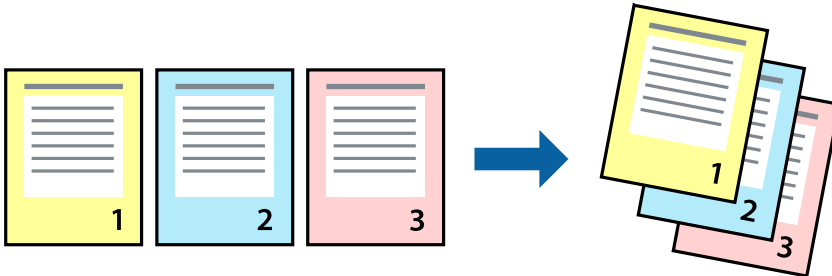

### Print Settings

On the printer driver's **Main** tab, select **Reverse Order**.

#### Related Information

- ➔ [“Printing Basics” on page 64](#)
- ➔ [“Main Tab” on page 80](#)

### Printing a Reduced or Enlarged Document

You can reduce or enlarge the size of a document by a specific percentage or to fit the paper size you loaded in the printer.



### Print Settings

On the printer driver's **More Options** tab, select the document size from the **Document Size** setting. Select the paper size you want to print on from the **Output Paper** setting. Select **Reduce/Enlarge Document**, and then select **Fit to Page** or **Zoom to**. When you select **Zoom to**, enter a percentage.

Select **Center** to print the images in the center of the page.

## Printing

**Note:**

*This feature is not available for borderless printing.*

**Related Information**

- ➔ [“Printing Basics” on page 64](#)
- ➔ [“More Options Tab” on page 81](#)

## Printing One Image on Multiple Sheets for Enlargement (Creating a Poster)

This feature allows you to print one image on multiple sheets of paper. You can create a larger poster by taping them together.

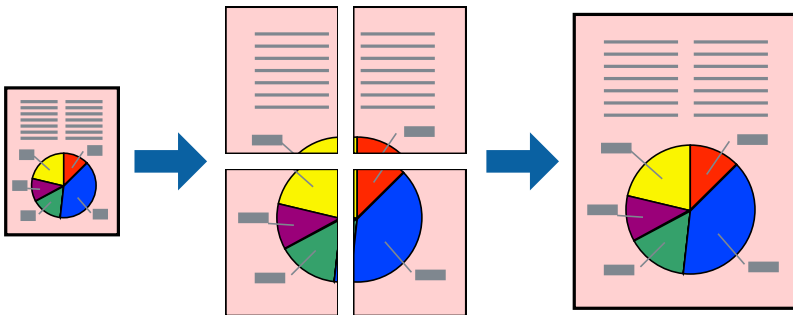
**Note:**

*This feature is not available for borderless printing.*

## Print Settings

On the printer driver's **Main** tab, select **2x1 Poster**, **2x2 Poster**, **3x3 Poster**, or **4x4 Poster** as the **Multi-Page** setting. If you click **Settings**, you can select the panels that you do not want to print. You can also select the cutting guide options.

**Related Information**

- ➔ [“Printing Basics” on page 64](#)
- ➔ [“Main Tab” on page 80](#)

### Making Posters Using Overlapping Alignment Marks

Here is an example of how to make a poster when **2x2 Poster** is selected, and **Overlapping Alignment Marks** is selected in **Print Cutting Guides**.

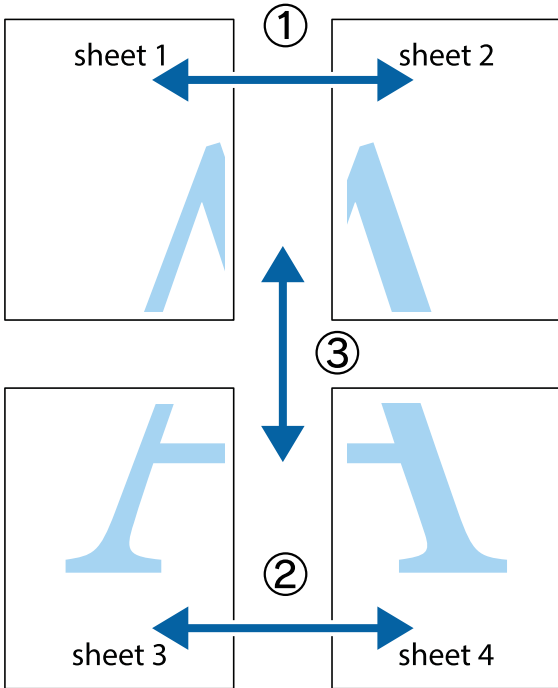

1. Prepare Sheet 1 and Sheet 2. Cut off the margins of Sheet 1 along the vertical blue line through the center of the top and bottom cross marks.

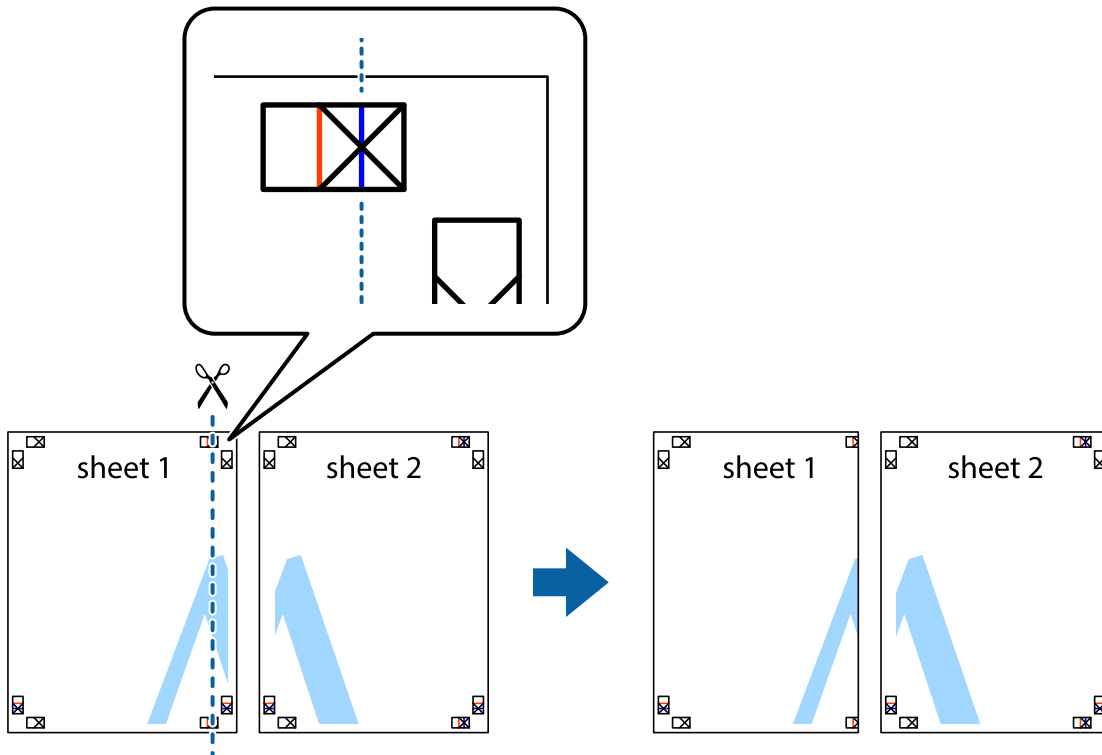

### Printing

2. Place the edge of Sheet 1 on top of Sheet 2 and align the cross marks, then temporarily tape the two sheets together from the back.

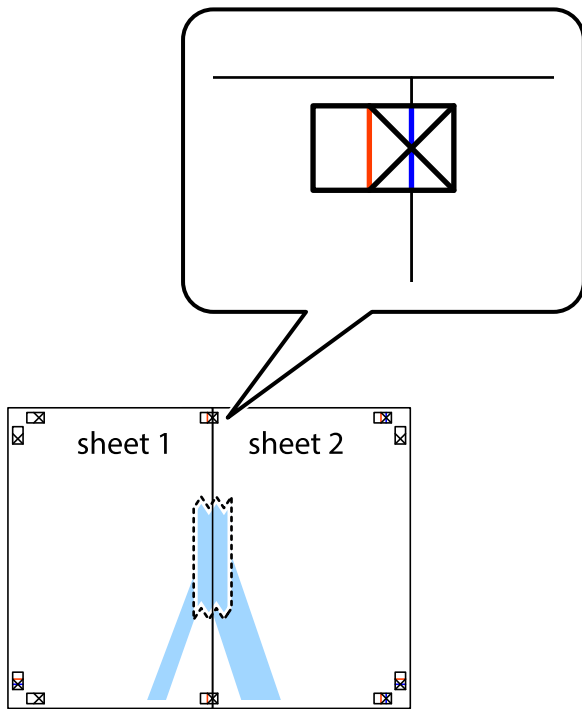

3. Cut the taped sheets in two along the vertical red line through the alignment markers (this time, the line to the left of the cross marks).



## Printing

4. Tape the sheets together from the back.



5. Repeat steps 1 to 4 to tape Sheet 3 and Sheet 4 together.
6. Cut off the margins of Sheet 1 and Sheet 2 along the horizontal blue line through the center of the left and right side cross marks.

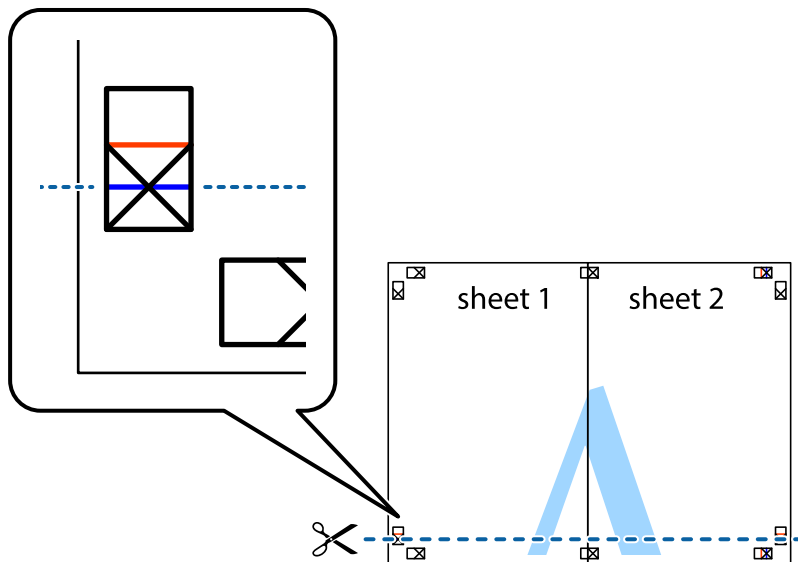



### Printing

7. Place the edge of Sheet 1 and Sheet 2 on top of Sheet 3 and Sheet 4 and align the cross marks, and then temporarily tape them together from the back.



### Printing

- Cut the taped sheets in two along the horizontal red line through the alignment markers (this time, the line above the cross marks).



- Tape the sheets together from the back.

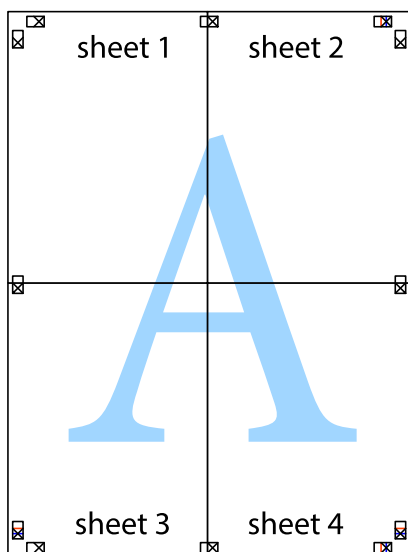

## Printing

10. Cut off the remaining margins along the outer guide.

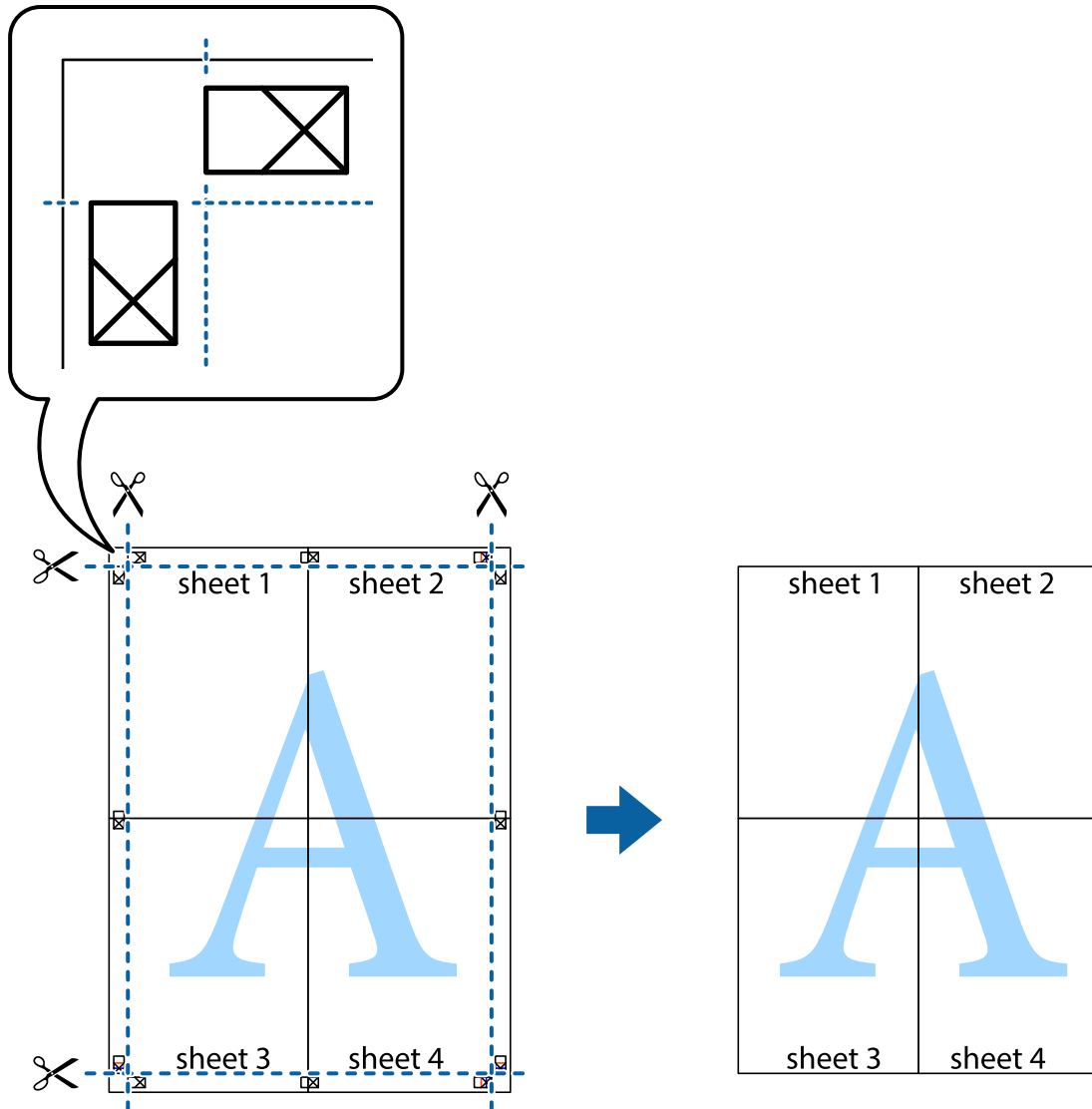

## Printing with a Header and Footer

You can print information such as a user name and printing date in headers or footers.

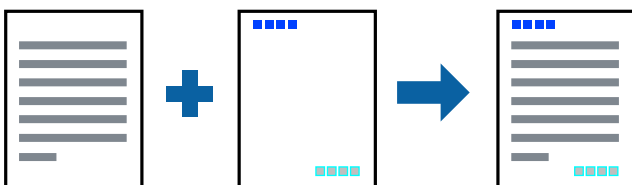

## Print Settings

On the printer driver's **More Options** tab, click **Watermark Features**, and then select **Header/Footer**. Click **Settings**, and then select the items you want to print.

## Printing

### Related Information

- ➔ [“Printing Basics” on page 64](#)
- ➔ [“More Options Tab” on page 81](#)

## Printing a Watermark

You can print a watermark such as "Confidential" or an anti-copy pattern on your printouts. If you print with an anti-copy pattern, the hidden letters appear when photocopied in order to distinguish the original from the copies.



The anti-copy pattern is available in the following conditions:

- Paper: Plain paper, Copy paper
- Borderless: Not selected
- Quality: Standard
- Automatic 2-sided printing: Not selected
- Color Correction: Automatic

**Note:**

*You can also add your own watermark or anti-copy pattern.*

## Print Settings

On the printer driver's **More Options** tab, click **Watermark Features**, and then select Anti-Copy Pattern or Watermark. Click **Settings** to change details such as the size, density, or position of the pattern or the mark.

### Related Information

- ➔ [“Printing Basics” on page 64](#)
- ➔ [“More Options Tab” on page 81](#)

## Printing

### Printing Multiple Files Together

Job Arranger Lite allows you to combine several files created by different applications and print them as a single print job. You can specify the print settings for combined files, such as multi-page layout, and 2-sided printing.

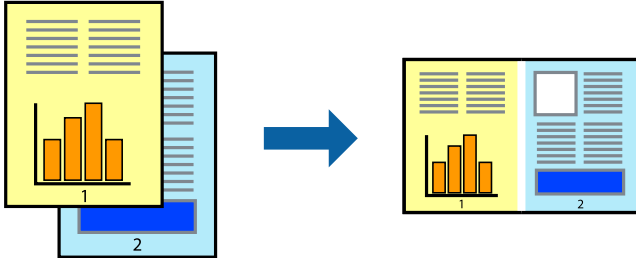

### Print Settings

On the printer driver's **Main** tab, select **Job Arranger Lite**. When you start printing, the Job Arranger Lite window is displayed. With the Job Arranger Lite window opened, open the file that you want to combine with the current file, and then repeat the above steps.

When you select a print job added to Print Project in the Job Arranger Lite window, you can edit the page layout.

Click **Print** from the **File** menu to start printing.

**Note:**

*If you close the Job Arranger Lite window before adding all the print data to the Print Project, the print job you are currently working on is canceled. Click **Save** from the **File** menu to save the current job. The extension of the saved files is ".ecl".*

*To open a Print Project, click **Job Arranger Lite** on the printer driver's **Maintenance** tab to open the Job Arranger Lite window. Next, select **Open** from the **File** menu to select the file.*

### Related Information

- ➔ ["Printing Basics" on page 64](#)
- ➔ ["Main Tab" on page 80](#)

### Printing Using the Color Universal Print Feature

You can enhance the visibility of texts and images in printouts.



Color Universal Print is only available when the following settings are selected.

- Paper Type: Plain paper
- Quality: **Standard** or a higher quality
- Print Color: **Color**
- Applications: Microsoft® Office 2007 or later

## Printing

- Text Size: 96 pts or smaller

### Print Settings

On the printer driver's **More Options** tab, click **Image Options** in the **Color Correction** setting. Select an option from the **Color Universal Print** setting. Click **Enhancement Options** to make further settings.

**Note:**

- Certain characters may be altered by patterns, such as "+" appearing as "±".
- Application-specific patterns and underlines may alter content printed using these settings.
- Print quality may decrease in photos and other images when using Color Universal Print settings.
- Printing is slower when using Color Universal Print settings.

#### Related Information

- ➔ ["Printing Basics" on page 64](#)
- ➔ ["More Options Tab" on page 81](#)

## Adjusting the Print Color

You can adjust the colors used in the print job.

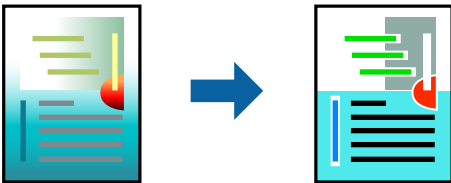

**Note:**

*These adjustments are not applied to the original data.*

### Print Settings

On the printer driver's **More Options** tab, select **Custom** as the **Color Correction** setting. Click **Advanced** to open the **Color Correction** window, and then select the method of color correction.

**Note:**

- Automatic** is selected as default on the **More Options** tab. With this setting, the colors are automatically adjusted to match the paper type and print quality settings.
- PhotoEnhance** on the **Color Correction** window adjusts the color by analyzing the location of the subject. Therefore, if you have changed the location of the subject by reducing, enlarging, cropping, or rotating the image, the color may change unexpectedly. Selecting the borderless setting also changes the location of the subject resulting in changes in color. If the image is out of focus, the tone may be unnatural. If the color is changed or becomes unnatural, print in a mode other than **PhotoEnhance**.

#### Related Information

- ➔ ["Printing Basics" on page 64](#)
- ➔ ["More Options Tab" on page 81](#)

## Printing to Emphasize Thin Lines

You can thicken thin lines that are too thin to print.

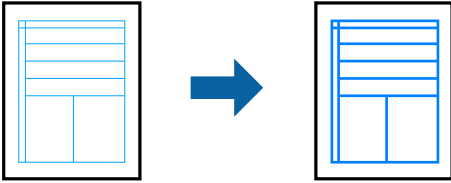

### Print Settings

On the printer driver's **More Options** tab, click **Image Options** in the **Color Correction** setting. Select **Emphasize Thin Lines**.

#### Related Information

- ➔ [“Printing Basics” on page 64](#)
- ➔ [“More Options Tab” on page 81](#)

## Printing Clear Bar Codes

You can print a bar code clearly and make it easy to scan. Only enable this feature if the bar code you printed cannot be scanned.

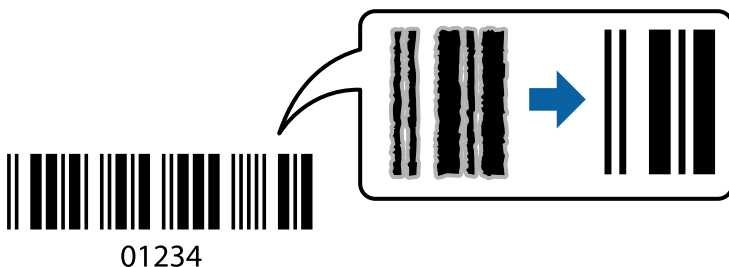

You can use this feature under the following conditions.

- Paper: Plain paper, Copy paper, or Envelope
- Quality: **Standard**, **Standard-Vivid**

The print quality may be changed when printing. The print speed may become slower and print density may become higher.

#### **Note:**

*Deblurring may not always be possible depending on the circumstances.*

### Print Settings

On the printer driver's **Maintenance** tab, click **Extended Settings**, and then select **Barcode mode**.

## Printing

### Related Information

- ➔ [“Printing Basics” on page 64](#)
- ➔ [“Maintenance Tab” on page 82](#)

## Canceling Printing

You can cancel a print job from the computer. However, you cannot cancel a print job from the computer once it has been completely sent to the printer. In this case, cancel the print job by using the printer's control panel.

### Canceling

On your computer, right-click on your printer in **Devices and Printers**, **Printer**, or in **Printers and Faxes**. Click **See what's printing**, right-click on the job you want to cancel, and then select **Cancel**.

## Menu Options for the Printer Driver

Open the print window in an application, select the printer, and then access the printer driver window.

**Note:**

*Menus vary depending on the option you selected.*

### Main Tab

Printing Presets	Add/Remove Presets	You can add or remove your own presets for frequently used print settings. Select the preset you want to use from the list.
Show Settings	Displays a list of items currently set on the <b>Main</b> and <b>More Options</b> tabs.	
Reset Defaults	Return all settings to their factory default values. The settings on the <b>More Options</b> tab are also reset to their defaults.	
Ink Levels	Displays the approximate ink levels.	
Paper Source	Select the paper source from which the paper is fed. Select <b>Auto Select</b> to automatically select the paper source selected in the print settings on the printer's control panel. If the printer has only one paper source, this item is not displayed.	
Document Size	Select the paper size on which you want to print. If you select <b>User-Defined</b> , enter the paper width and height.	
Borderless	Enlarges the print data slightly more than the paper size so that no margins are printed around the edges of the paper. Click <b>Settings</b> to select the amount of enlargement.	
Orientation	Select the orientation you want to use to print.	
Paper Type	Select the type of paper on which you print.	
Quality	Select the print quality you want to use for printing. Available settings depend on the paper type you select. Click <b>More Settings</b> to make further settings.	
Color	Select the color for your print job.	



## Printing

2-Sided Printing	Allows you to perform 2-sided printing.	
	Settings	You can specify the binding edge and the binding margins. When printing multi-page documents, you can select to print starting from either the front or the back side of the page.
	Print Density	Select the document type to adjust the print density. If the appropriate print density is selected, you can prevent images from bleeding through to the reverse side. Select <b>User Defined</b> to adjust the print density manually.
Multi-Page	Allows you to print several pages on one sheet or perform poster printing. Click <b>Page Order</b> to specify the order in which pages are printed.	
Copies	Set the number of copies you want to print.	
	Collate	Prints multi-page documents collated in order and sorted into sets.
	Reverse Order	Allows you to print from the last page so that the pages are stacked in the correct order after printing.
Quiet Mode	Reduces the noise the printer makes. However, enabling this may reduce print speed.	
Print Preview	Displays a preview of your document before printing.	
Job Arranger Lite	Select to print using the Job Arranger Lite feature.	

## More Options Tab

Printing Presets	Add/Remove Presets	You can add or remove your own presets for frequently used print settings. Select the preset you want to use from the list.
Show Settings	Displays a list of items currently set on the <b>Main</b> and <b>More Options</b> tabs.	
Reset Defaults	Return all settings to their factory default values. The settings on the <b>Main</b> tab are also reset to their defaults.	
Document Size	Select the size of your document.	
Output Paper	Select the paper size on which you want to print. If the <b>Output Paper</b> differs from the <b>Document Size</b> , <b>Reduce/Enlarge Document</b> is selected automatically. You do not have to select it when printing without reducing or enlarging the size of a document.	
Reduce/Enlarge Document	Allows you to reduce or enlarge the size of a document.	
	Fit to Page	Automatically reduce or enlarge the document to fit to the paper size selected in <b>Output Paper</b> .
	Zoom to	Prints with a specific percentage.
	Center	Prints images in the center of the paper.
Color Correction	Automatic	Adjusts the colors of images automatically.
	Custom	Allows you to perform manual color correction. Click <b>Advanced</b> for further settings.
	Image Options	Enables print quality options such as Color Universal Print or Fix Red-Eye. You can also thicken thin lines to make them visible on the printouts.

## Printing

Watermark Features	Allows you to make settings for anti-copy pattern or watermarks.	
Additional Settings	Rotate 180°	Rotates pages 180 degrees before printing. This feature is helpful when printing on paper such as envelopes that are loaded in fixed direction in the printer.
	High Speed	Prints when the print head moves in both directions. The print speed is faster, but the quality may decline.
	Mirror Image	Inverts an image to print as it would appear in a mirror.

## Maintenance Tab

Nozzle Check	Prints a nozzle check pattern to check if the print head nozzles are clogged.
Head Cleaning	Cleans the clogged nozzles in the print head. Because this feature uses some ink, clean the print head only if the nozzles are clogged.
Job Arranger Lite	Opens the Job Arranger Lite window. You can save and edit data.
EPSON Status Monitor 3	Opens the EPSON Status Monitor 3 window. Here you can confirm the status of the printer and the consumables.
Monitoring Preferences	Allows you to make settings for items on the EPSON Status Monitor 3 window.
Extended Settings	Allows you to make a variety of settings. Right-click each item to view the Help for more details.
Print Queue	Displays the jobs waiting to be printed. You can check, pause, or resume print jobs.
Language	Changes the language to be used on the printer driver window. To apply the settings, close the printer driver, and then open it again.
Software Update	Starts EPSON Software Updater to check for the latest version of applications on the Internet.
Online Order	Allows you to access the site where you can purchase Epson's ink cartridges.
Technical Support	Allows you to access the Epson technical support website.

---

## Printing from the Printer Driver on Mac OS

### Printing Basics

**Note:**

*Operations differ depending on the application. See the application's help for details.*

1. Open the file you want to print.  
Load paper in the printer if it has not already been loaded.
2. Select **Print** from the **File** menu or another command to access the print dialog.  
If necessary, click **Show Details** or ▼ to expand the print window.
3. Select your printer.

## Printing

4. Select **Print Settings** from the pop-up menu.

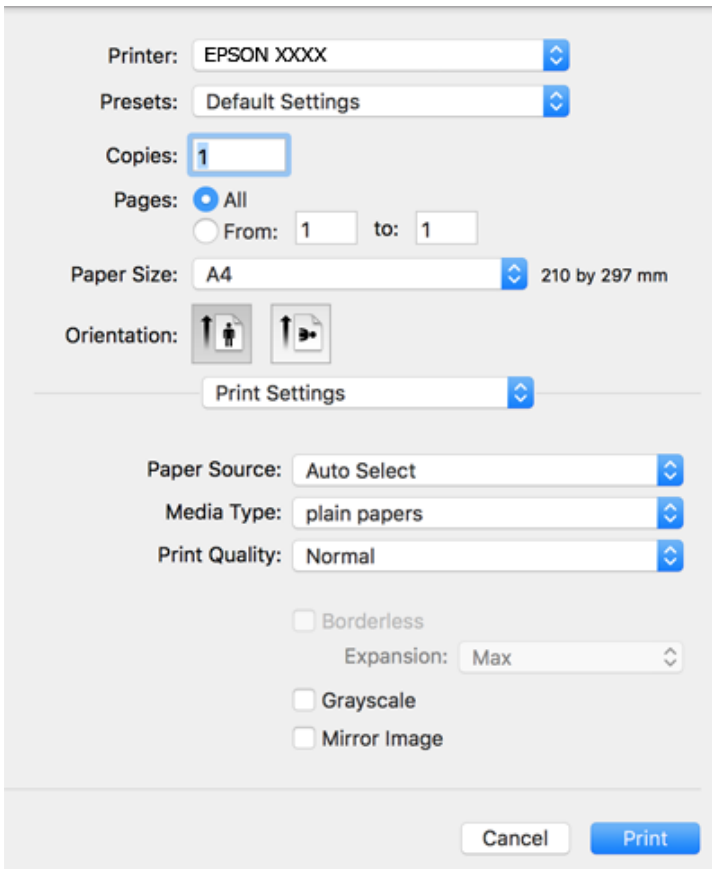

**Note:**

On OS X Mountain Lion or later, if the **Print Settings** menu is not displayed, the Epson printer driver has not been installed correctly.

Select **System Preferences** from the  menu > **Printers & Scanners** (or **Print & Scan**, **Print & Fax**), remove the printer, and then add the printer again. See the following to add a printer.

<http://epson.sn>

5. Change the settings as necessary.  
See the menu options for the printer driver for details.
6. Click **Print**.

### Related Information

- ➔ “Available Paper and Capacities” on page 43
- ➔ “Loading Paper in the Paper Cassette” on page 45
- ➔ “List of Paper Type” on page 48
- ➔ “Menu Options for Print Settings” on page 88

## Printing

### Printing on 2-Sides

You can print on both sides of the paper.

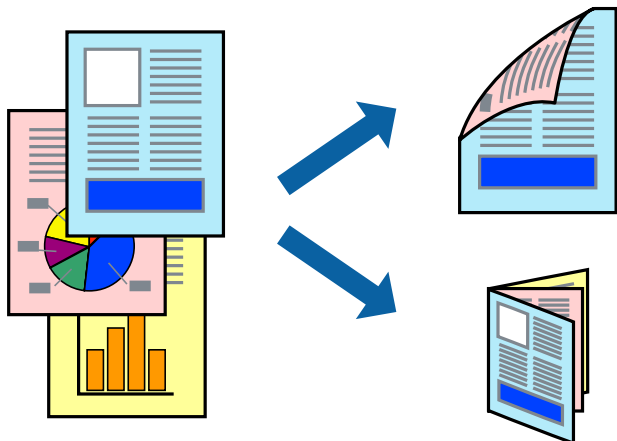

**Note:**

- This feature is not available for borderless printing.
- If you do not use paper that is suitable for 2-sided printing, the print quality may decline and paper jams may occur.
- Depending on the paper and the data, ink may bleed through to the other side of the paper.

#### Related Information

➔ [“Available Paper and Capacities” on page 43](#)

### Print Settings

Select **Two-sided Printing Settings** from the pop-up menu. Select the method of 2-sided printing, and then make the **Document Type** settings.

**Note:**

- Printing speed may be reduced depending on the document type.
- When printing photos with dense data, select **Text & Graphics** or **Text & Photos** in the **Document Type** setting. If the printouts are smeared or ink bleeds through to the other side of the paper, adjust the **Print Density** and **Increased Ink Drying Time** in **Adjustments**.

#### Related Information

- ➔ [“Printing Basics” on page 82](#)
- ➔ [“Menu Options for Two-sided Printing Settings” on page 89](#)

## Printing

### Printing Several Pages on One Sheet

You can print two or four pages of data on a single sheet of paper.

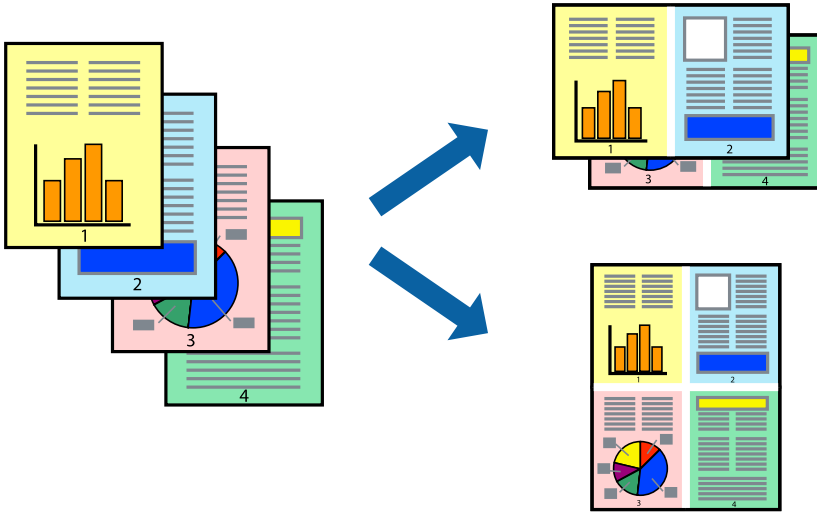

### Print Settings

Select **Layout** from the pop-up menu. Set the number of pages in **Pages per Sheet**, the **Layout Direction** (page order), and **Border**.

#### Related Information

- ➔ [“Printing Basics” on page 82](#)
- ➔ [“Menu Options for Layout” on page 88](#)

### Printing and Stacking in Page Order (Reverse Order Printing)

You can print from the last page so that the documents are stacked in page order.

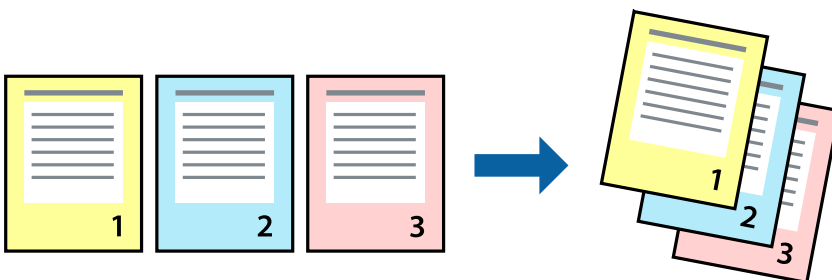

### Print Settings

Select **Paper Handling** from the pop-up menu. Select **Reverse** as the **Page Order** setting.

#### Related Information

- ➔ [“Printing Basics” on page 82](#)

## Printing

➔ [“Menu Options for Paper Handling” on page 88](#)

### Printing a Reduced or Enlarged Document

You can reduce or enlarge the size of a document by a specific percentage or to fit the paper size you loaded in the printer.



### Print Settings

When printing to fit to the paper size, select **Paper Handling** from the pop-up menu, and then select **Scale to fit paper size**. Select the paper size you loaded in the printer in **Destination Paper Size**. When reducing the size of the document, select **Scale down only**.

When printing at a specific percentage, do one of the following.

- Select **Print** from the **File** menu of the application. Select **Printer**, enter a percentage in **Scale**, and then click **Print**.
- Select **Page Setup** from the **File** menu of the application. Select your printer in **Format For**, enter a percentage in **Scale**, and then click **OK**.

**Note:**

Select the paper size you set in the application as the **Paper Size** setting.

### Related Information

- ➔ [“Printing Basics” on page 82](#)
- ➔ [“Menu Options for Paper Handling” on page 88](#)

## Adjusting the Print Color

You can adjust the colors used in the print job.

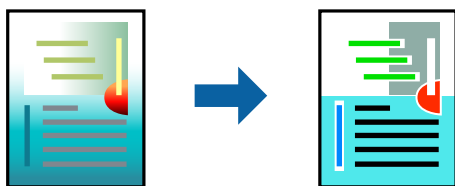

**Note:**

*These adjustments are not applied to the original data.*

## Print Settings

Select **Color Matching** from the pop-up menu, and then select **EPSON Color Controls**. Select **Color Options** from the pop-up menu, and then select one of the available options. Click the arrow next to **Advanced Settings**, and then make more detailed settings.

### Related Information

- ➔ [“Printing Basics” on page 82](#)
- ➔ [“Menu Options for Color Matching” on page 88](#)
- ➔ [“Menu Options for Color Options” on page 89](#)

## Canceling Printing

You can cancel a print job from the computer. However, you cannot cancel a print job from the computer once it has been completely sent to the printer. In this case, cancel the print job by using the printer's control panel.

### Canceling

Click the printer icon in the **Dock**. Select the job you want to cancel, and then do one of the following.

- OS X Mountain Lion or later

Click  next to the progress meter.

- Mac OS X v10.6.8 to v10.7.x

Click **Delete**.

## Menu Options for the Printer Driver

Open the print window in an application, select the printer, and then access the printer driver window.

**Note:**

*Menus vary depending on the option you selected.*

## Printing

### Menu Options for Layout

Pages per Sheet	Select the number of pages to be printed on one sheet.
Layout Direction	Specify the order in which the pages will be printed.
Border	Prints a border around the pages.
Reverse page orientation	Rotates pages 180 degrees before printing. Select this item when printing on paper such as envelopes that are loaded in fixed direction in the printer.
Flip horizontally	Inverts an image to print as it would appear in a mirror.

### Menu Options for Color Matching

ColorSync	Select the method for color adjustment. These options adjust colors between the printer and the computer display to minimize the difference in color.
EPSON Color Controls	

### Menu Options for Paper Handling

Collate pages	Prints multi-page documents collated in order and sorted into sets.	
Pages to Print	Select to print only odd pages or even pages.	
Page Order	Select to print from the top or the last page.	
Scale to fit paper size	Prints to fit to the paper size you loaded.	
	Destination Paper Size	Select the paper size to print on.
	Scale down only	Select when reducing the size of the document.

### Menu Options for Cover Page

Print Cover Page	Select whether or not to print a cover page. When you want to add a back cover, select <b>After document</b> .
Cover Page Type	Select the contents of the cover page.

### Menu Options for Print Settings

Paper Source	Select the paper source from which the paper is fed. If the printer has only one paper source, this item is not displayed. Selecting <b>Auto Select</b> selects the paper source that matches the paper setting on the printer automatically.
Media Type	Select the type of paper on which you print.
Print Quality	Select the print quality you want to use for printing. The options vary depending on the paper type.



## Printing

Borderless	This checkbox is selected when you select a borderless paper size.	
	Expansion	In borderless printing, the print data is enlarged slightly more than the paper size so that no margins are printed around the edges of the paper. Select the amount of enlargement.
Grayscale	Select when you want to print in black or shades of gray.	
Mirror Image	Inverts an image to print as it would appear in a mirror.	

### Menu Options for Color Options

Manual Settings	Adjusts the color manually. In <b>Advanced Settings</b> , you can select detailed settings.
PhotoEnhance	Produces sharper images and more vivid colors by automatically adjusting the contrast, saturation, and brightness of the original image data.
Off (No Color Adjustment)	Print without enhancing or adjusting the color in any way.

### Menu Options for Two-sided Printing Settings

Two-sided Printing	Prints on both sides of the paper.
--------------------	------------------------------------

## Making Operation Settings for the Mac OS Printer Driver

### Accessing the Operation Settings Window of the Mac OS Printer Driver

Select **System Preferences** from the  menu > **Printers & Scanners** (or **Print & Scan**, **Print & Fax**), and then select the printer. Click **Options & Supplies** > **Options** (or **Driver**).

### Operation Settings of the Mac OS Printer Driver

- Skip Blank Page: Avoids printing blank pages.
- Quiet Mode: Prints quietly. However, the print speed may be slower.
- Permit temporary black printing: Prints only with black ink temporarily.
- High Speed Printing: Prints when the print head moves in both directions. The print speed is faster, but the quality may decline.
- Output documents for filing: Feed the paper so that it is easy to file when printing landscape data or 2-sided printing. Envelope printing is not supported.
- Remove white borders: Removes unnecessary margins during borderless printing.
- Warning Notifications: Allows the printer driver to display warning notifications.
- Establish bidirectional communication: Usually, this should be set to **On**. Select **Off** when acquiring the printer information is impossible because the printer is shared with Windows computers on a network or for any other reason.

---

## Printing from Smart Devices

### Using Epson iPrint

Epson iPrint is an application that allows you to print photos, documents, and web pages from a smart device such as a smartphone or tablet. You can use local print, printing from a smart device that is connected to the same wireless network as your printer, or remote print, printing from a remote location over the Internet. To use remote print, register your printer in the Epson Connect service.



#### Related Information

➔ [“Printing Using a Network Service” on page 179](#)

### Installing Epson iPrint

You can install Epson iPrint on your smart device from the following URL or QR code.

<http://ipr.to/c>



### Printing Using Epson iPrint

Start Epson iPrint from your smart device and select the item you want to use from the home screen.

## Printing

The following screens are subject to change without notice. The contents may vary depending on the product.

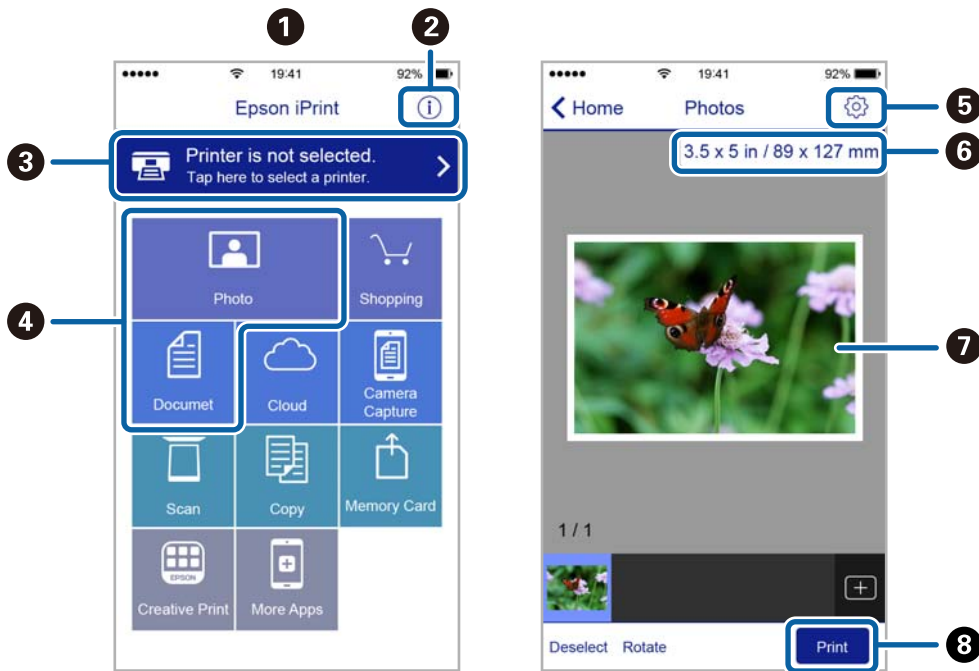

1	Home screen displayed when the application is started.
2	Displays information on how to setup the printer and a FAQ.
3	Displays the screen where you can select the printer and make printer settings. Once you have selected the printer, you do not need to select it again from the next time.
4	Select what you want to print such as photos and documents.
5	Displays the screen to make print settings such as paper size and paper type.
6	Displays the paper size. When this is displayed as a button, press it to display the paper settings currently set on the printer.
7	Displays photos and documents you selected.
8	Starts printing.

**Note:**

To print from the document menu using iPhone, iPad, and iPod touch running iOS, start Epson iPrint after transferring the document you want to print using the file sharing function in iTunes.

## Printing by Touching Smart Devices to the NFC Tag

You can connect the printer and your smart device automatically and print by touching the NFC antenna of a smart device running Android 4.0 or later and that supports NFC (Near Field Communication) to the printer's NFC tag.

The location of the NFC antenna varies depending on the smart device. See the documentation provided with your smart device for more details.

## Printing

### **!** Important:

- ❑ Make sure that the Wi-Fi Direct (Simple AP) connection setting is enabled.
- ❑ Enable the NFC function on your smart device.
- ❑ Make sure that Epson iPrint is installed on your smart device. If not, touch the NFC antenna of the smart device to the printer's NFC tag and install it.

### Note:

- ❑ If the printer does not communicate with the smart device even after touching it to the tag, try adjusting the position of the smart device and touch it to the tag again.
- ❑ If there are obstacles such as metal between the printer's NFC tag and the NFC antenna of the smart device, the printer may not be able to communicate with the smart device.
- ❑ This feature uses a Wi-Fi Direct (Simple AP) connection to connect to the printer. You can connect up to four devices to the printer at the same time.
- ❑ If you have changed the password for the Wi-Fi Direct (Simple AP) connection, you cannot use this feature. Restore the initial password to use this feature.

1. Load paper in the printer.
2. Touch the NFC antenna of your smart device to the printer's NFC tag.

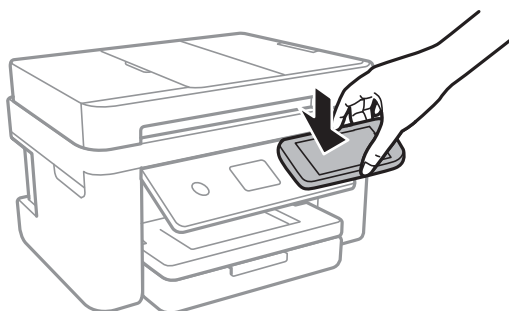

Epson iPrint starts.

3. On the Epson iPrint home screen, touch the NFC antenna of your smart device to the printer's NFC tag again. The printer and the smart device are connected.
4. Select the image you want to print, and then select **Next** at the top right of the screen.
5. Touch the NFC antenna of your smart device to the printer's NFC tag again.

Printing starts.

## Using Epson Print Enabler

You can wirelessly print your documents, emails, photos, and web pages right from your Android phone or tablet (Android v4.4 or later). With a few taps, your Android device will discover an Epson printer that is connected to the same wireless network.

1. Load paper in the printer.
2. Set up your printer for wireless printing.

## Printing

3. On your Android device, install the Epson Print Enabler plug-in from Google Play.
4. Connect your Android device to the same wireless network as your printer.
5. Go to **Settings** on your Android device, select **Printing**, and then enable Epson Print Enabler.
6. From an Android application such as Chrome, tap the menu icon and print whatever is on the screen.

**Note:**

*If you do not see your printer, tap **All Printers** and select your printer.*

### Related Information

- ➔ “Loading Paper in the Paper Cassette” on page 45
- ➔ “Connecting to a Smart Device” on page 24

## Using AirPrint

AirPrint enables instant wireless printing from iPhone, iPad, and iPod touch with the latest version of iOS, and Mac with the latest version of OS X or macOS.



**Note:**

*If you disabled paper configuration messages on your product control panel, you cannot use AirPrint. See the link below to enable the messages, if necessary.*

1. Load paper in your product.
2. Set up your product for wireless printing. See the link below.  
<http://epson.sn>
3. Connect your Apple device to the same wireless network that your product is using.
4. Print from your device to your product.

**Note:**

*For details, see the AirPrint page on the Apple website.*

### Related Information

- ➔ “Loading Paper in the Paper Cassette” on page 45
- ➔ “Printer Settings” on page 57

---

## Canceling the Ongoing Job

Tap  on the printer's control panel to cancel the print job in progress.

# Copying

---

## Copying Basics

This section explains the steps for basic copying.

1. Place the originals.

If you want to copy multiple originals, place all of the originals on the ADF.

2. Select **Copy** on the home screen.

3. Check the settings on the **Copy** tab.

Select the setting item to change it as necessary.

**Note:**

If you select **Advanced Settings** tab, you can make settings such as **Multi-Page** or **Quality**.

If the combination of settings you require is not available,  is displayed. Select the icon to check the details, and then change the settings.

4. Enter the number of copies.

5. Tap .

### Related Information

- ➔ [“Placing Originals” on page 49](#)
- ➔ [“Basic Menu Options for Copying” on page 96](#)
- ➔ [“Advanced Menu Options for Copying” on page 96](#)
- ➔ [“Basic Screen Configuration” on page 17](#)

---

## Copying on 2-Sides

You can copy multiple originals on both sides of the paper.

1. Select **Copy** on the home screen.

2. Select **Copy** tab > , and then select **1→2-Sided**.

You can also specify the orientation of the original and the binding position of the copy result.

3. Tap .

### Related Information

- ➔ [“Copying Basics” on page 95](#)

---

## Copying Multiple Originals onto One Sheet

You can copy two originals onto a single sheet of paper.

1. Select **Copy** on the home screen.
2. Select **Advanced Settings** tab > **Multi-Page**, and select **2-up**.  
You can also specify the layout order and orientation of the original.
3. Select **Copy** tab, and then tap .

### Related Information

➔ [“Copying Basics” on page 95](#)

---

## Basic Menu Options for Copying

### Note:

*The items may not be available depending on other settings you made.*

#### B&W:

Copies the original in black and white (monochrome).

#### Color:

Copies the original in color.



#### (2-Sided) :

Select 2-sided layout.

1→1-Sided

Copies one side of an original onto a single side of paper.

1→2-Sided

Copies two single-sided originals onto both sides of a single sheet of paper. Select the orientation of your original and the binding position of the paper.



#### (Density) :

Increase the level of density when the copying results are faint. Decrease the level of density when ink smears.

---

## Advanced Menu Options for Copying

### Note:

*The items may not be available depending on other settings you made.*



## Copying

### Paper Setting:

Select paper size and paper type.

### Reduce/Enlarge:

Configures the magnification ratio of the enlargement or reduction. If you want to reduce or enlarge the original by a specific percentage, select the value, and then enter a percentage within a range of 25 to 400%.

Actual Size

Copies at 100 % magnification.

A4→A5 and others

Automatically enlarges or reduces the original to fit to a specific paper size.

Auto Fit Page

Detects the scan area and automatically enlarges or reduces the original to fit to the paper size you selected. When there are white margins around the original, the white margins from the corner mark of the scanner glass are detected as the scan area, but the margins at the opposite side may be cropped.

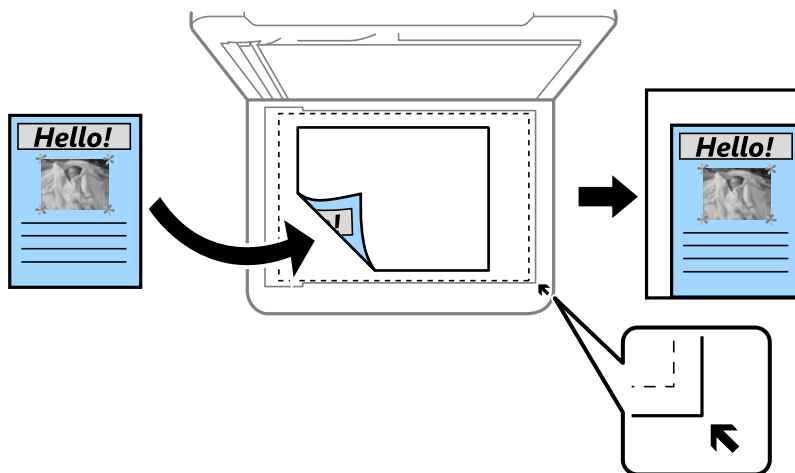

### Original Size:

Select the size of your original. When copying non-standard size originals, select the size closest to your original.

### Multi-Page:

Single Page

Copies a single-sided original onto a single sheet.

2-up

Copies two single-sided originals onto a single sheet in 2-up layout. Select the layout order and the orientation of your original.

### Quality:

Select the print quality. **Best** provides higher quality printing, but the printing speed may be slower.

### Original Orientation:

Select the orientation of your original.

## Copying

### Remove Shadow:

Removes shadows that appear around copies when copying thick paper or that appear in the center of copies when copying a booklet.

### Remove Punch Holes:

Removes the binding holes when copying.

### ID Card Copy:

Scans both sides of an ID card and copies onto one side of A4 size paper.

### Borderless Copy:

Copies without margins around the edges. The image is enlarged a little to remove margins from the edges of the paper. Select how much to enlarge in the **Expansion** setting.

### Clear All Settings:

Resets the copy settings to their defaults.

# Scanning

---

## Scanning Using the Control Panel

You can send scanned images from the printer's control panel to the following destinations.

### Computer

You can save the scanned image to a computer connected to the printer. Before scanning, install Epson Scan 2 and Epson Event Manager on your computer.

### Cloud

You can send scanned images to cloud services. Before scanning, make settings on the Epson Connect.

### Computer (WSD)

You can save the scanned image to a computer connected to the printer, using WSD feature. If you are using the Windows 7/Windows Vista, you need to make WSD settings on your computer before scanning.

### Related Information

- ➔ [“Scanning to a Computer \(Event Manager\)” on page 99](#)
- ➔ [“Scanning to the Cloud” on page 103](#)
- ➔ [“Scanning to a Computer \(WSD\)” on page 105](#)

## Scanning to a Computer (Event Manager)

### Note:

Before scanning, install Epson Scan 2 and Epson Event Manager on your computer.

1. Place the originals.
2. Select **Scan** on the home screen.
3. Select **Computer**.
4. Select  to select the computer to which you want to save the scanned images.

### Note:

- When the printer is connected to a network, you can select the computer to which you want to save the scanned image. You can display up to 20 computers on the printer's control panel. If you set **Network Scan Name (Alphanumeric)** on Epson Event Manager, it is displayed on the control panel.

5. Select  to select how to save the scanned image to a computer.
  - Save as JPEG: Saves the scanned image in JPEG format.
  - Save as PDF: Saves the scanned image in PDF format.
  - Attach to e-mail: Starts the email client on your computer, and then automatically attaches it to an email.

## Scanning

- ❑ Follow custom setting: Saves the scanned image using the settings on the Epson Event Manager. You can change the scan settings such as the scanning size, folder to save to, or save format.

6. Tap .

### Related Information

➔ [“Placing Originals” on page 49](#)

## Making Custom Settings in Epson Event Manager

You can set the scan settings for **Follow custom setting** in Epson Event Manager.

See the Epson Event Manager help for details.

1. Start Epson Event Manager.
2. Make sure that your scanner is selected as the **Scanner** on the **Button Settings** tab on the main screen.

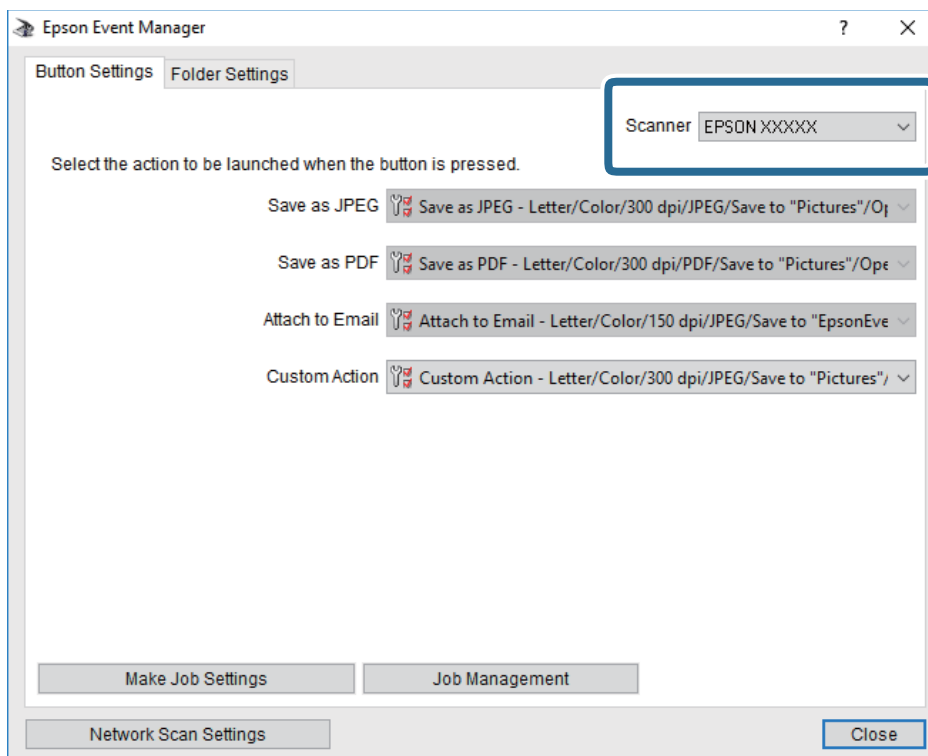

## Scanning

3. Click **Make Job Settings**.

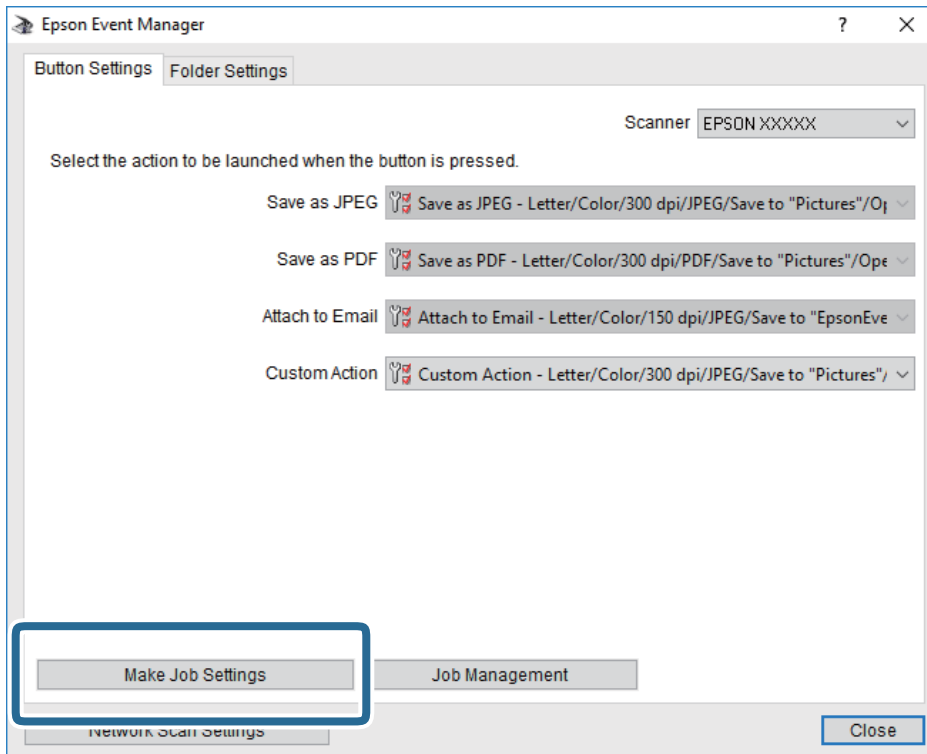

## Scanning

4. Make scan settings on the **Job Settings** screen.

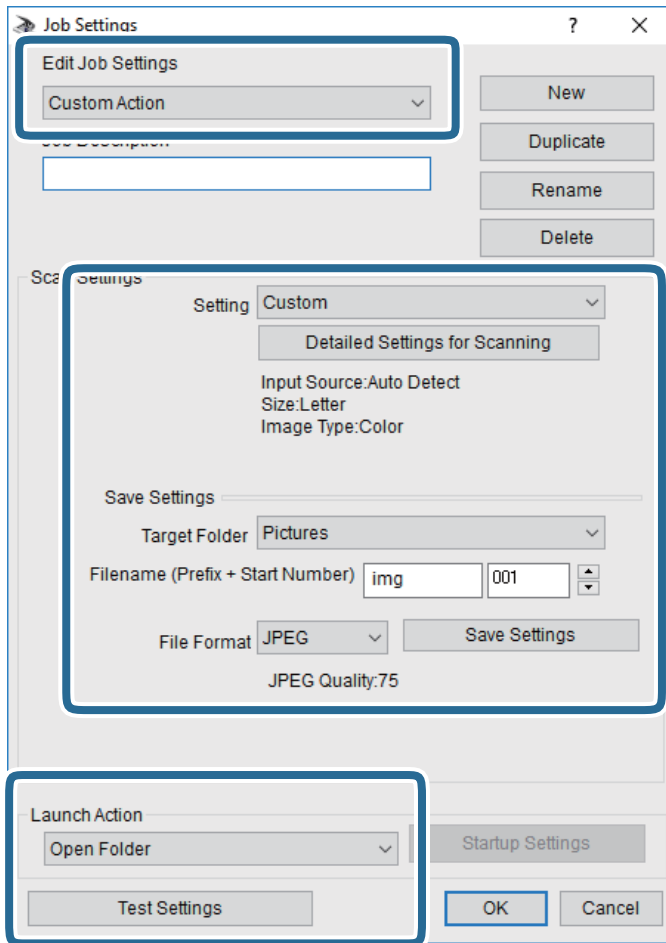

- Edit Job Settings: Select **Custom Action**.
- Setting: Scan using the best settings for the selected type of original. Click **Detailed Settings for Scanning** to set the items such as the resolution or the color for saving the scanned image.
- Target Folder: Select the save folder for the scanned image.
- Filename (Prefix + Start Number): Change the settings for the file name you want to save.
- File Format: Select the save format.
- Launch Action: Select the action when scanning.
- Test Settings: Starts test scanning using current settings.

5. Click **OK** to return to the main screen.

## Scanning

6. Make sure that the **Custom Action** is selected on the **Custom Action** list.

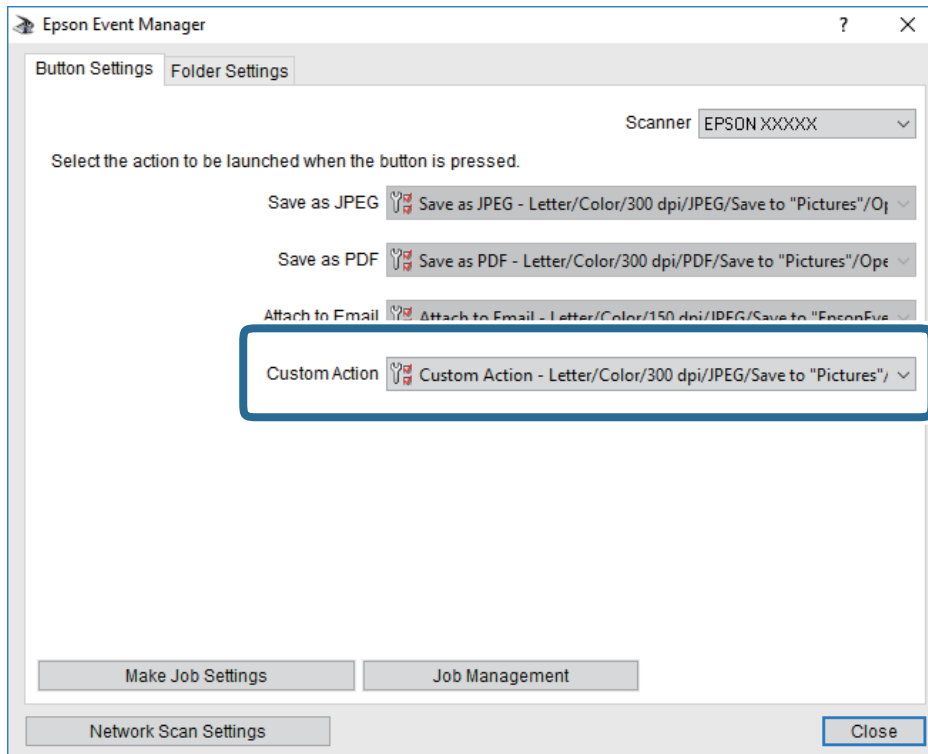

7. Click **Close** to close Epson Event Manager.

## Scanning to the Cloud

You can send scanned images to cloud services. Before using this feature, make settings using Epson Connect. See the following Epson Connect portal website for details.

<https://www.epsonconnect.com/>

<http://www.epsonconnect.eu> (Europe only)

1. Make sure that you have made settings using Epson Connect.
2. Place the originals.
3. Select **Scan** on the home screen.
4. Select **Cloud**.
5. Select **+** on the top of the screen, and then select a destination.
6. Set items on **Scan** tab, such as the save format.
7. Select **Advanced Settings** tab, and then check settings, and change them if necessary.
8. Select **Scan** tab, and then tap **◇**.

## Scanning

### Related Information

➔ [“Placing Originals” on page 49](#)

## Basic Menu Options for Scanning to the Cloud

### Note:

*The items may not be available depending on other settings you made.*

#### B&W/Color:

Select whether to scan in color or in monochrome.

#### JPEG/PDF:

Select the format in which to save the scanned image.

## Advanced Menu Options for Scanning to the Cloud

### Note:

*The items may not be available depending on other settings you made.*

#### Scan Area:

##### Scan Size:

Select the scan size. To crop the white space around the text or image when scanning, select **Auto Cropping**. To scan at the maximum area of the scanner glass, select **Max Area**.

##### Original Orientation:

Select the orientation of the original.

#### Original Type:

Select the type of your original.

#### Density:

Select the contrast of the scanned image.

#### Remove Shadow:

Remove the shadows of the original that appear in the scanned image.

##### Surround:

Remove the shadows at the edge of the original.

##### Center:

Remove the shadows of the binding margin of the booklet.

#### Remove Punch Holes:

Remove the punch holes that appear in the scanned image. You can specify the area to erase the punch holes by entering a value in the box on the right.

##### Erasing Position:

Select the position to remove the punch holes.



## Scanning

- Original Orientation:**  
Select the orientation of the original.

### Clear All Settings

Resets the scan settings to their defaults.

## Scanning to a Computer (WSD)

### **Note:**

- This feature is only available for computers running Windows 10/Windows 8.1/Windows 8/Windows 7/Windows Vista.*
- If you are using Windows 7/Windows Vista, you need to setup your computer in advance using this feature.*

1. Place the originals.
2. Select **Scan** on the home screen.
3. Select **Computer (WSD)**.
4. Select a computer.
5. Tap .

## Setting Up a WSD Port

This section explains how to set up a WSD port for Windows 7/Windows Vista.

### **Note:**

*For Windows 10/Windows 8.1/Windows 8, the WSD port is set up automatically.*

The following is necessary to set up a WSD port.

- The printer and the computer are connected to the network.
  - The printer driver is installed on the computer.
1. Turn the printer on.
  2. Click start, and then click **Network** on the computer.
  3. Right-click the printer, and then click **Install**.  
Click **Continue** when the **User Account Control** screen is displayed.

## Scanning

Click **Uninstall** and start again if the **Uninstall** screen is displayed.

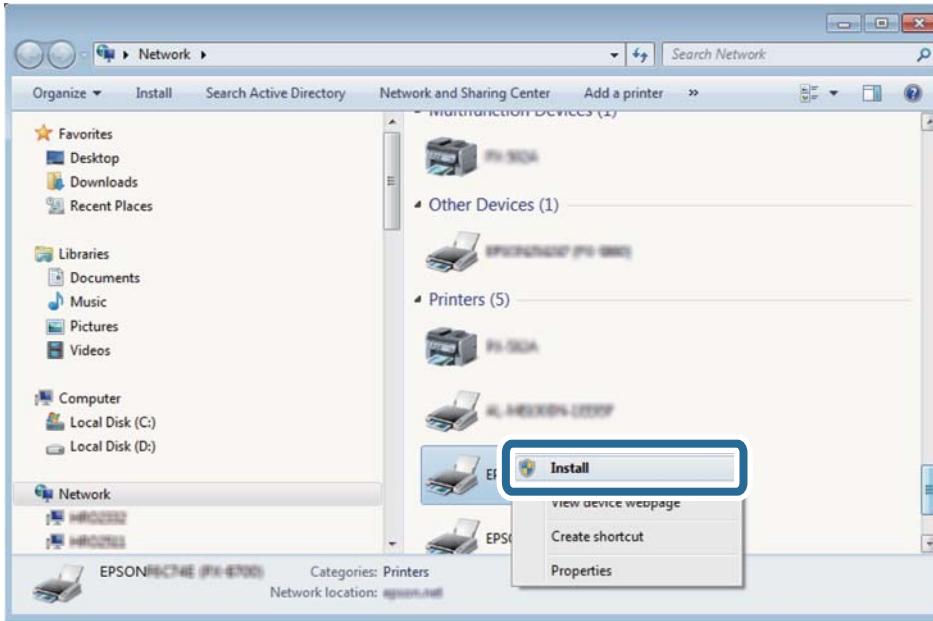

**Note:**

The printer name you set on the network and model name (EPSON XXXXXX (XX-XXXX)) are displayed on the network screen. You can check the printer's name set on the network from the printer's control panel or by printing a network status sheet.

4. Click **Your device is ready to use**.

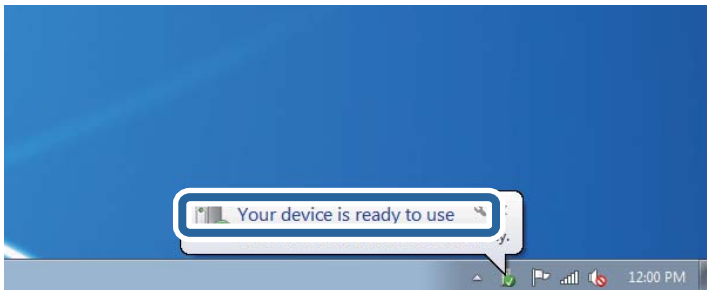

5. Check the message, and then click **Close**.

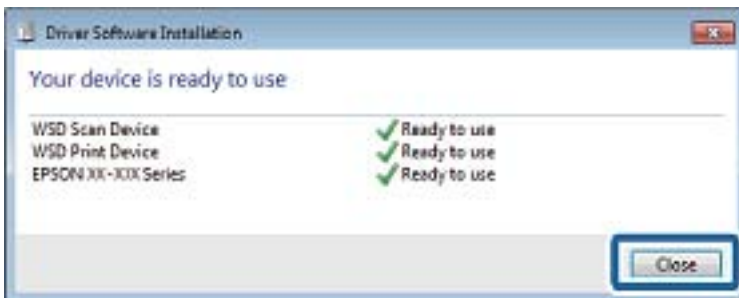

6. Open the **Devices and Printers** screen.

- ❑ Windows 7

Click start > **Control Panel** > **Hardware and Sound** (or **Hardware**) > **Devices and Printers**.

## Scanning

- ❑ Windows Vista

Click start > **Control Panel** > **Hardware and Sound** > **Printers**.

7. Check that an icon with the printer's name on the network is displayed.  
Select the printer name when using with WSD.

---

# Scanning from a Computer

## Scanning Using Epson Scan 2

You can scan by using the scanner driver "Epson Scan 2". See the Epson Scan 2 help for an explanation of each setting item.

### Related Information

- ➔ ["Placing Originals" on page 49](#)
- ➔ ["Application for Scanning Documents and Images \(Epson Scan 2\)" on page 169](#)

## Scanning Documents (Document Mode)

Using **Document Mode** in Epson Scan 2, you can scan originals using detailed settings that are suitable for text documents.

1. Place the originals.

**Note:**

*If you want to scan multiple originals, place them into the ADF.*

2. Start Epson Scan 2.
3. Select **Document Mode** from the **Mode** list.

## Scanning

4. Make the following settings on the **Main Settings** tab.

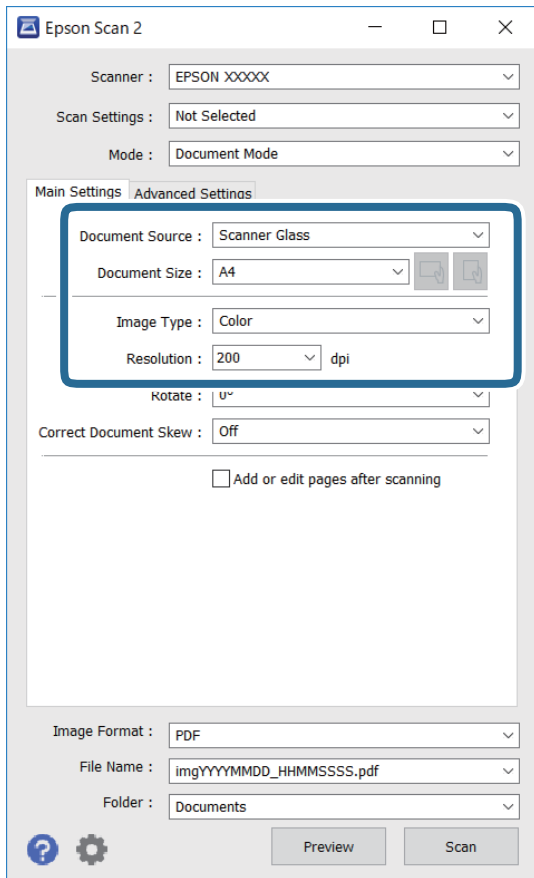

- Document Source: Select the source where the original is placed.
- Document Size: Select the size of the original you placed.
-  (Original orientation) buttons: Select the set orientation of the original you placed. Depending on the size of the original, this item may be set automatically and cannot be changed.
- Image Type: Select the color for saving the scanned image.
- Resolution: Select the resolution.

5. Make other scan settings if necessary.

- You can preview the scanned image by clicking the **Preview** button. The preview window opens, and the previewed image is displayed.  
When you performed preview using ADF, original is ejected from the ADF. Place the ejected original again.

## Scanning

- ❑ On the **Advanced Settings** tab, you can make detailed image adjustment settings that are suitable for text documents, such as the following.
  - ❑ **Remove Background:** Remove the background of the originals.
  - ❑ **Text Enhancement:** You can make blurred letters in the original clear and sharp.
  - ❑ **Auto Area Segmentation:** You can make letters clear and images smooth when performing black and white scanning for a document that contains images.
  - ❑ **Color Enhance:** You can enhance the color specified for the scanned image, and then save it in grayscale or black and white.
  - ❑ **Brightness:** You can adjust the brightness for the scanned image.
  - ❑ **Contrast:** You can adjust the contrast for the scanned image.
  - ❑ **Gamma:** You can adjust the gamma (brightness of the intermediate range) for the scanned image.
  - ❑ **Threshold:** You can adjust the border for monochrome binary (black and white).
  - ❑ **Unsharp Mask:** You can enhance and sharpen the outlines of the image.
  - ❑ **Descreening:** You can remove moiré patterns (web-like shadows) that appear when scanning printed papers such as a magazine.
  - ❑ **Edge Fill:** You can remove the shadow created around the scanned image.
  - ❑ **Dual Image Output (Windows Only):** You can scan once and save two images with different output settings at the same time.

**Note:**

*The items may not be available depending on other settings you made.*

## Scanning

### 6. Set the file saving settings.

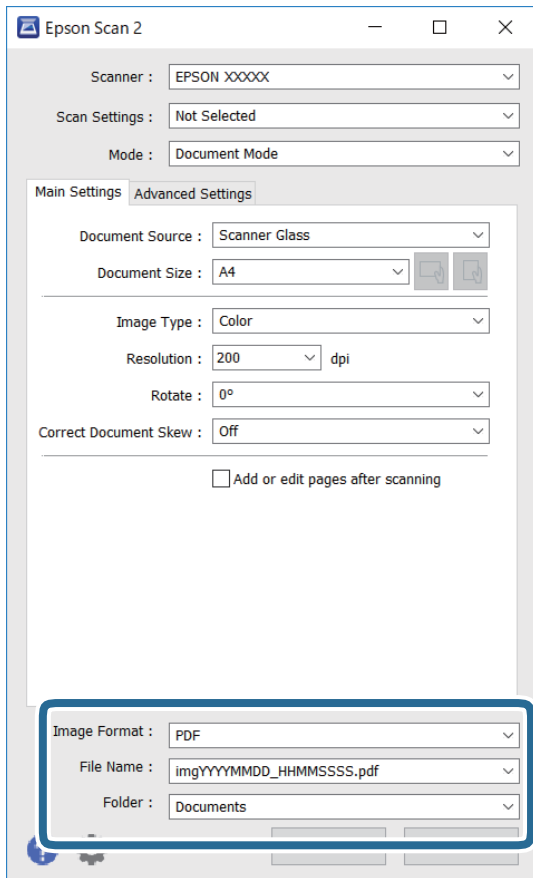

- Image Format:** Select the save format from the list.

You can make detailed settings for each save format except BITMAP and PNG. Select **Options** from the list after selecting the save format.

- File Name:** Confirm the save file name displayed.

You can change settings for the file name by selecting **Settings** from the list.

- Folder:** Select the save folder for the scanned image from the list.

You can select another folder or create a new folder by selecting **Select** from the list.

### 7. Click **Scan**.

## Scanning Photos or Pictures (Photo Mode)

Using **Photo Mode** in Epson Scan 2, you can scan originals with wide variety of image adjustment features that are suitable for photos or pictures.

#### 1. Place the originals.

By placing multiple originals on the scanner glass, you can scan them all at the same time. Make sure there is a gap of at least 20 mm between the originals.

**Note:**

*You cannot use ADF when scanning from **Photo Mode**.*

## Scanning

2. Start Epson Scan 2.
3. Select **Photo Mode** from the **Mode** list.
4. Make the following settings on the **Main Settings** tab.

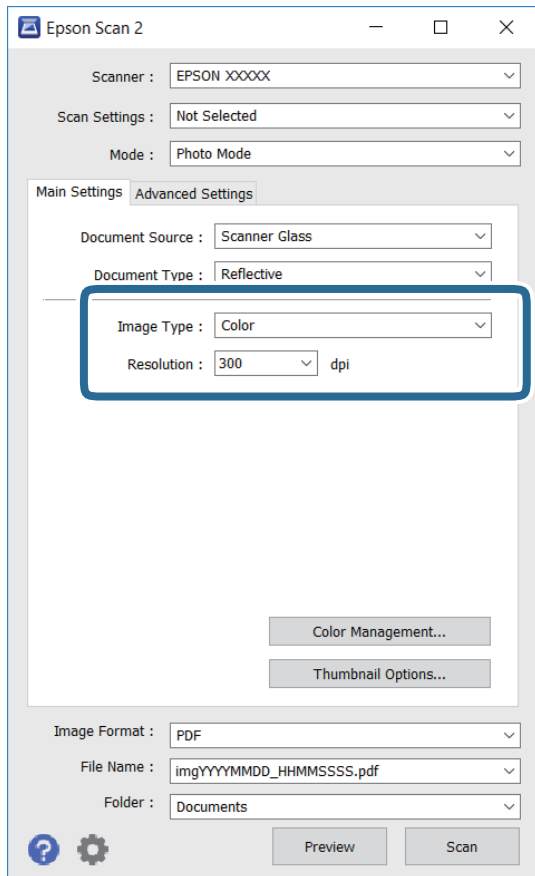

- Image Type: Select the color for saving the scanned image.
- Resolution: Select the resolution.

**Note:**

The **Document Source** setting is fixed as **Scanner Glass**, and the **Document Type** setting is fixed as **Reflective**. (**Reflective** means originals which are not transparent, for example ordinary papers or photos.) You cannot change these settings.

## Scanning

5. Click **Preview**.

The preview window opens, and the previewed images are displayed as thumbnails.

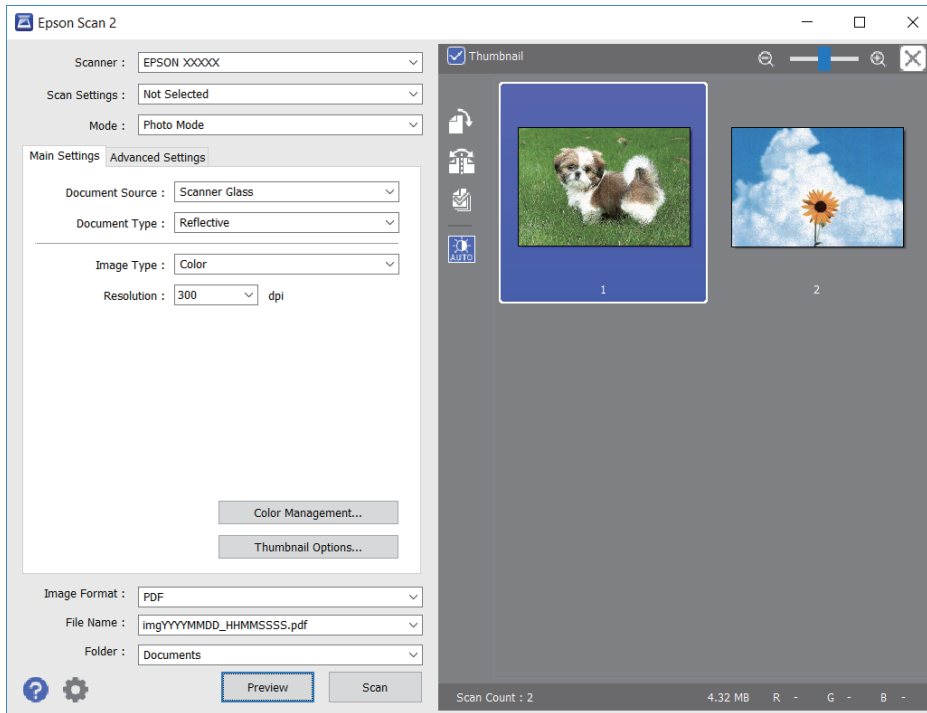

**Note:**

To preview the entire scanned area, clear the **Thumbnail** check box at the top of the preview window.

6. Confirm the preview, and make image adjustment settings on the **Advanced Settings** tab if necessary.

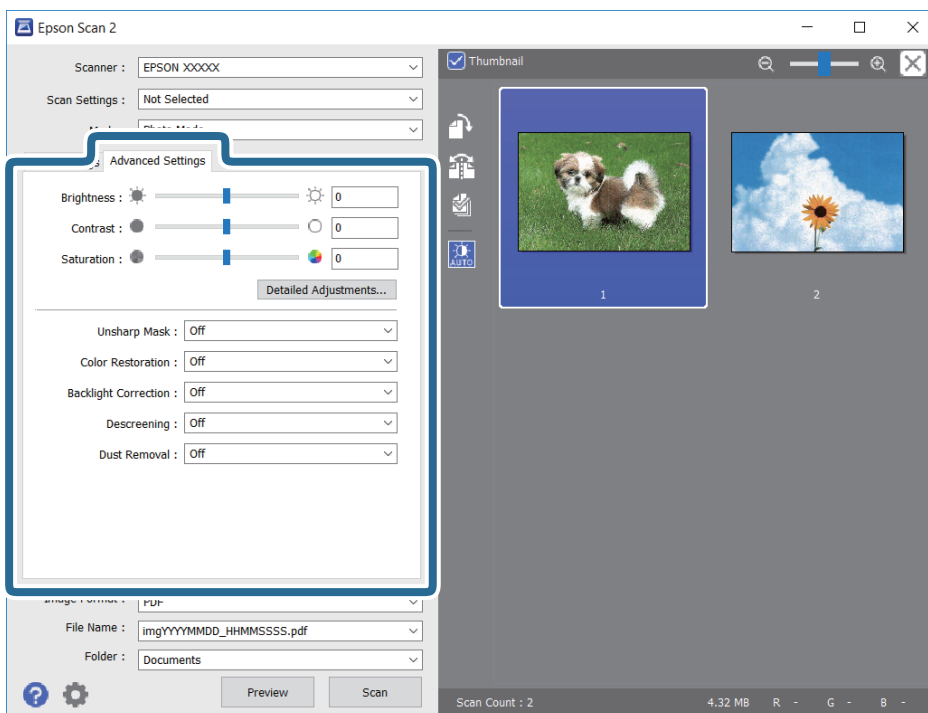



## Scanning

You can adjust the scanned image using detailed settings that are suitable for photos or pictures, such as the following.

- Brightness:** You can adjust the brightness for the scanned image.
- Contrast:** You can adjust the contrast for the scanned image.
- Saturation:** You can adjust the saturation (color vividness) for the scanned image.
- Unsharp Mask:** You can enhance and sharpen the outlines of the scanned image.
- Color Restoration:** You can correct images that have faded to return them to their original colors.
- Backlight Correction:** You can lighten scanned images that are dark due to backlight.
- Descreening:** You can remove moiré patterns (web-like shadows) that appear when scanning printed papers such as a magazine.
- Dust Removal:** You can remove dust on the scanned image.

**Note:**

- The items may not be available depending on other settings you made.*
- Depending on the original, the scanned image may not be adjusted correctly.*
- When multiple thumbnails are created, you can adjust the image quality for each thumbnail. Depending on the adjustment items, you can adjust the quality of scanned images all together by selecting multiple thumbnails.*

### 7. Set the file saving settings.

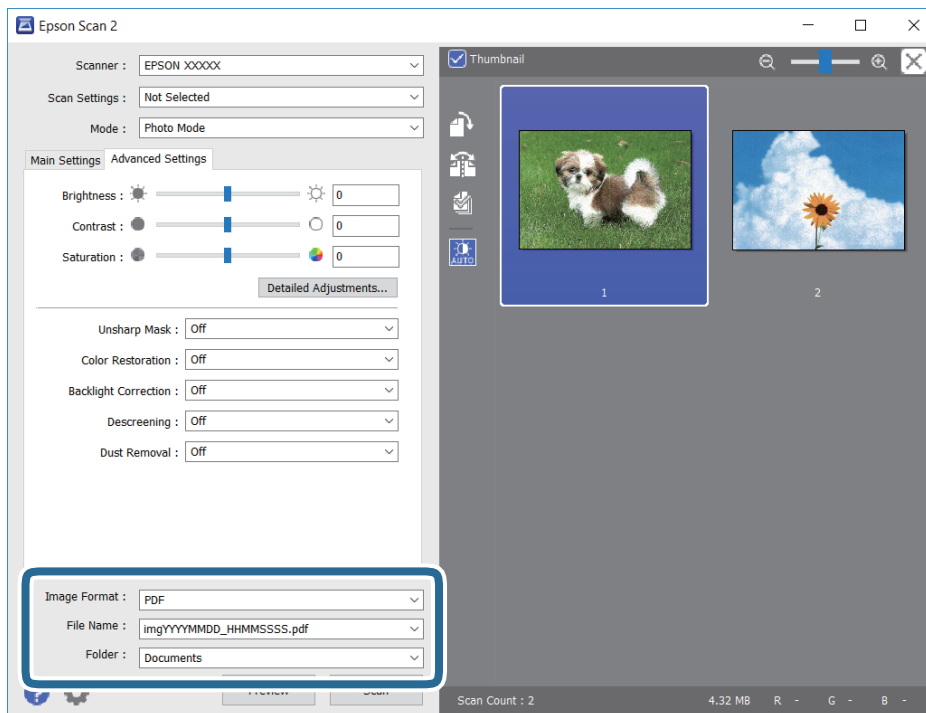

- Image Format:** Select the save format from the list.  
You can make detailed settings for each save format except BITMAP and PNG. Select **Options** from the list after selecting the save format.
- File Name:** Confirm the save file name displayed.  
You can change settings for the file name by selecting **Settings** from the list.

## Scanning

- Folder: Select the save folder for the scanned image from the list.

You can select another folder or create a new folder by selecting **Select** from the list.

8. Click **Scan**.

---

## Scanning from Smart Devices

Epson iPrint is an application that allows you to scan photos and documents from a smart device, such as a smartphone or tablet, that is connected to the same wireless network as your printer. You can save the scanned data on a smart device or to Cloud services, send it by email, or print it.



### Installing Epson iPrint

You can install Epson iPrint on your smart device from the following URL or QR code.

<http://ipr.to/c>



### Scanning by Touching Smart Devices to the NFC Tag

Even if your smart device does not make any settings to use the printer, you can automatically connect it and scan by touching the NFC antenna of a smart device to the printer's NFC Tag.

Make sure that you prepare the followings to use this feature.

- Enable the NFC function on your smart device.
- Epson iPrint is installed on your smart device. If not, touch the NFC tag antenna of the smart device to the printer's NFC Tag to install it.

**Note:**

- Android 4.0 or later supports NFC (Near Field Communication)*
- The location of the NFC antenna varies depending on the smart device. See the documentation provided with your smart device for more details.*
- The printer may not be able to communicate with the smart device when there are obstacles such as metal between the printer's NFC Tag and the NFC antenna of the smart device,*

1. Place the originals in the printer.

## Scanning

2. Touch the NFC antenna of your smart device to the printer's NFC Tag.

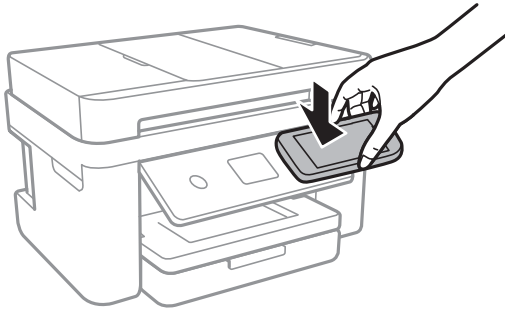

Epson iPrint starts.

3. Select the scan menu in Epson iPrint.
4. Touch the NFC antenna of your smart device to the printer's NFC Tag again.

Scanning starts.

## Scanning Using Epson iPrint

Start Epson iPrint from your smart device and select the item you want to use from the home screen.

The following screens are subject to change without notice.



1	Home screen displayed when the application is started.
2	Displays information on how to setup the printer and a FAQ.

**Scanning**

3	Displays the screen where you can select the printer and make printer settings. Once you have selected the printer, you do not need to select it again from the next time.
4	Displays the scanning screen.
5	Displays the screen where you can make scan settings such as resolution.
6	Displays scanned images.
7	Starts scanning.
8	Displays the screen where you can save scanned data to a smart device or Cloud services.
9	Displays the screen where you can send scanned data by email.
10	Displays the screen where you can print scanned data.

# Faxing

---

## Setting Up a Fax

### Connecting to a Phone Line

#### Compatible Telephone Lines

You can use the printer over standard analogue telephone lines (PSTN = Public Switched Telephone Network) and PBX (Private Branch Exchange) telephone systems.

You may not be able to use the printer with the following phone lines or systems.

- VoIP phone line such as DSL or fiber-optic digital service
- Digital phone line (ISDN)
- Some PBX telephone systems
- When adapters such as terminal adapters, VoIP adapters, splitters, or DSL router are connected between the telephone wall jack and the printer

#### Connecting the Printer to a Phone Line

Connect the printer to a telephone wall jack using an RJ-11 (6P2C) phone cable. When connecting a telephone to the printer, use a second RJ-11 (6P2C) phone cable.

Depending on the area, a phone cable may be included with the printer. If it is included, use that cable.

You may need to connect the phone cable to an adapter provided for your country or region.

**Note:**

*Remove the cap from the EXT. port of the printer only when connecting your telephone to the printer. Do not remove the cap if you are not connecting your telephone.*

In areas where lightning strikes occur frequently, we recommend that you use a surge protector.

## Faxing

### Connecting to a Standard Phone Line (PSTN) or PBX

Connect a phone cable from the telephone wall jack or PBX port to the LINE port on the back of the printer.

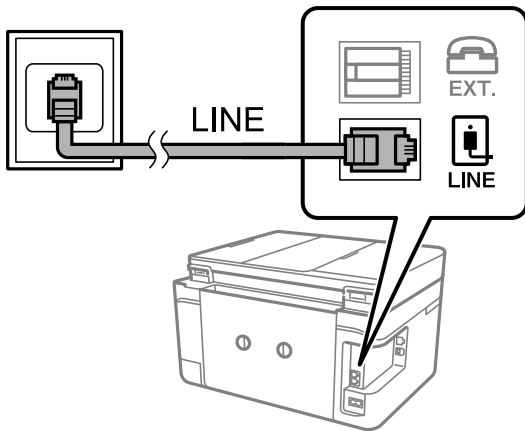

### Related Information

➔ [“Making Settings for a PBX Phone System” on page 122](#)

### Connecting to DSL or ISDN

Connect a phone cable from the DSL modem or the ISDN terminal adapter to the LINE port on the back of the printer. See the documentation provided with the modem or the adapter for more details.

**Note:**

*If your DSL modem is not equipped with a built-in DSL filter, connect a separate DSL filter.*

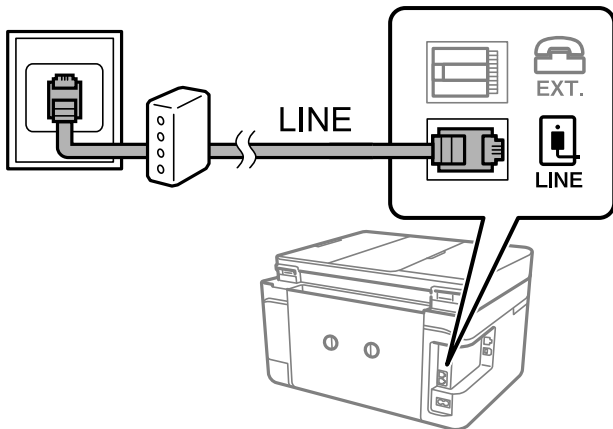

### Connecting Your Phone Device to the Printer

When using the printer and your telephone on a single phone line, connect the telephone to the printer.

**Note:**

- ❑ *If your phone device has a fax function, disable the fax function before connecting. See the manuals that came with the phone device for details.*
- ❑ *If you connect an answering machine, make sure the printer's **Rings to Answer** setting is set higher than the number of rings your answering machine is set to answer a call.*

## Faxing

1. Remove the cap from the EXT. port on the back of the printer.

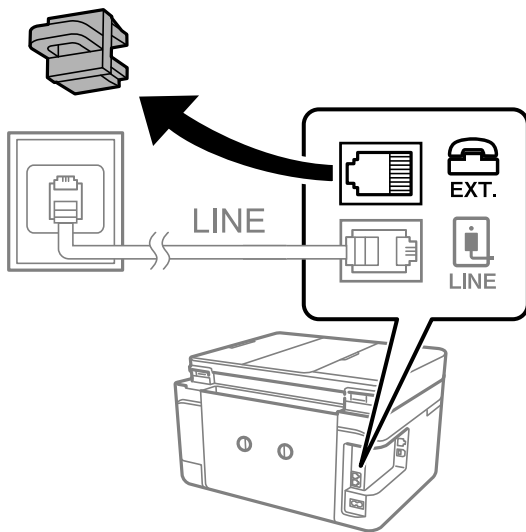

2. Connect the phone device and the EXT. port with a phone cable.

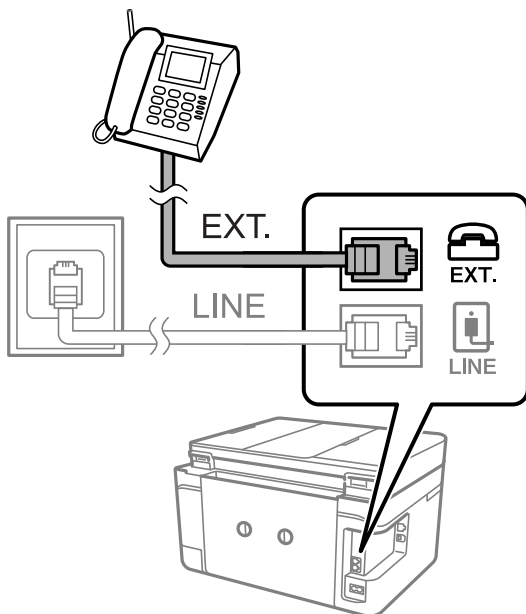

**Note:**

*When sharing a single phone line, make sure you connect the phone device to the EXT. port of the printer. If you split the line to connect the phone device and the printer separately, the phone and the printer do not work correctly.*

3. Select **Fax** on the home screen.

## Faxing

- Pick up the handset.

The connection is established when **Send** is enabled as the following screen.

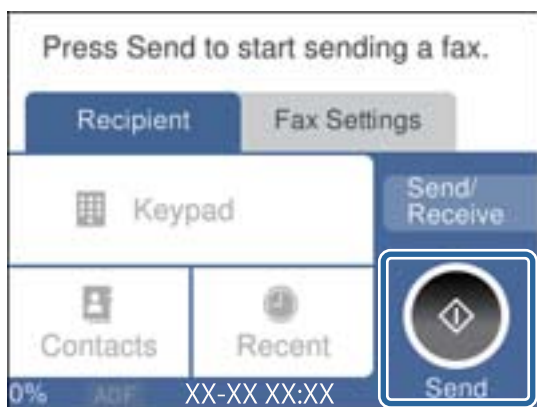

### Related Information

➔ [“Settings for the Answering Machine” on page 129](#)

## Making Basic Fax Settings

First make basic fax settings such as **Receive Mode** using the **Fax Setting Wizard**, and then configure the other settings as necessary.

The **Fax Setting Wizard** is automatically displayed when the printer is turned on for the first time. Once you have made the settings, you do not need to make them again unless the connection environment is changed.

## Making Basic Fax Settings Using the Fax Setting Wizard

Make basic settings by following the on-screen instructions.

- Connect the printer to the phone line.

**Note:**

*Because an automatic fax connection check runs at the end of the wizard, make sure you connect the printer to the phone line before starting the wizard.*

- Select **Settings** on the home screen.
- Select **General Settings** > **Fax Settings** > **Fax Setting Wizard**.
- On the **Fax Setting Wizard** screen, tap **Proceed**.

The wizard begins.

- On the fax header entry screen, enter the sender name such as your company name, and then tap **OK**.

**Note:**

*Your sender name and your fax number appear as the header for outgoing faxes.*

- On the phone number entry screen, enter your fax number, and then tap **OK**.



## Faxing

7. On the **Distinctive Ring Detection (DRD) Setting** screen, make the following settings.
  - If you have subscribed to a distinctive ring service from your telephone company: Select **Settings** , and then select the ring pattern to be used for incoming faxes.
    - If you select **All**, go to step 8.
    - If you select any other setting, **Receive Mode** is automatically set to **Auto**. Go to step 10.
  - If you do not need to set this option: Tap **Skip**, and then go to step 10.

**Note:**

- Distinctive ring services, offered by many telephone companies (the service name differs by company), allows you to have several phone numbers on one phone line. Each number is assigned a different ring pattern. You can use one number for voice calls and another for fax calls. Select the ring pattern assigned to fax calls in **DRD**.*
  - Depending on the region, **On** and **Off** are displayed as the **DRD** options. Select **On** to use the distinctive ring feature.*
8. On the **Receive Mode Setting** screen, select whether you are using your phone device connected to the printer.
    - When connected: Select **Yes**, and then go to the next step.
    - When not connected: Select **No**, and then go to step 10. **Receive Mode** is set to **Auto**.
  9. On the **Receive Mode Setting** screen, select whether you want to receive faxes automatically.
    - To receive automatically: Select **Yes**. **Receive Mode** is set to **Auto**.
    - To receive manually: Select **No**. **Receive Mode** is set to **Manual**.
  10. On the **Proceed** screen, check the settings you made, and then tap **Proceed**.

To correct or change settings, tap .

11. Select **Start Checking** to run the fax connection check, and when the screen prompts you to print the check result, select **Print**.

A report of the check result that shows the connection status is printed.

**Note:**

- If there are any errors reported, follow the instructions on the report to solve them.*
- If the **Select Line Type** screen is displayed, select the line type.*
  - *When you are connecting the printer to a PBX phone system or terminal adapter, select **PBX**.*
  - *When you are connecting the printer to a standard phone line, select **PSTN**, and then select **Do Not Detect** on the **Confirmation** screen displayed. However, setting this to **Do Not Detect** may cause the printer to skip the first digit of a fax number when dialing and send the fax to the wrong number.*

### Related Information

- ➔ [“Connecting the Printer to a Phone Line” on page 117](#)
- ➔ [“Setting Receive Mode” on page 128](#)
- ➔ [“Making Settings for a PBX Phone System” on page 122](#)
- ➔ [“Menu Options for Fax Settings” on page 143](#)

## Making Basic Fax Settings Individually

You can make fax settings without using the fax setting wizard by selecting each setting menu individually. The settings configured using the wizard can also be changed. For more details, see the list of menus in fax settings.

## Faxing

### Related Information

➔ [“Menu Options for Fax Settings” on page 143](#)

### **Making Settings for a PBX Phone System**

Make the following settings when using the printer in offices that use extensions and require external access codes, such as 0 and 9, to get an outside line.

1. Select **Settings** on the home screen.
2. Select **General Settings > Fax Settings > Basic Settings**.
3. Select **Line Type**, and then select **PBX**.
4. When sending a fax to an outside fax number using # (hash) instead of the actual external access code, select the **Access Code** box to make this to **Use**.

The #, entered instead of the actual access code, is replaced with the stored access code when dialing. Using # helps avoid connection problems when connecting to an outside line.

**Note:**

*You cannot send faxes to recipients in **Contacts** that have external access codes such as 0 and 9.*

*If you have registered recipients in **Contacts** using an external access code such as 0 and 9, set the **Access Code** to **Do Not Use**. Otherwise, you must change the code to # in **Contacts**.*

5. Tap the **Access Code** input box, enter the external access code used for your phone system, and then tap **OK**.
6. Select **OK** to apply the settings.  
The access code is stored in the printer.

### **Making Information Settings to be Printed on Received Faxes**

You can set to print reception information in the footer of the received fax, even if the sender has not set the header information. The reception information includes the received date and time, sender's ID, and page number (such as "P1"). When **Split Page Settings** is enabled, the split page number is also included.

1. Select **Settings** on the home screen.
2. Select **General Settings > Fax Settings > Receive Settings**.
3. Select **Print Settings**, and then tap the **Add Reception Information** to set this to **On**.

### Related Information

➔ [“Print Settings” on page 144](#)

### **Making Settings to Print Received Faxes on 2-Sides**

You can print multiple pages of received documents on both sides of the paper.

1. Select **Settings** on the home screen.

## Faxing

2. Select **General Settings** > **Fax Settings** > **Receive Settings**.
3. Select **Print Settings**, and then select **2-Sided**.
4. Tap the **2-Sided** field to set this to **On**.
5. In **Binding Margin**, select **Short Side** or **Long Side**.
6. Select **OK**.

### Related Information

➔ [“Print Settings” on page 144](#)

## Making Settings to Print Received Faxes by Splitting Pages

Make split page settings when the size of the received document is larger than the size of the paper loaded in the printer.

1. Select **Settings** on the home screen.
2. Select **General Settings** > **Fax Settings** > **Receive Settings**.
3. Select **Print Settings** > **Split Page Settings** > **Delete Print Data After Split**.
4. Select the options for deleting print data after splitting.
  - If you select **Off**, select **OK** and go to step 6.
  - If you select **Delete Top** or **Delete Bottom**, go to next step.
5. In **Threshold**, set the threshold, and then select **OK**.
6. Select **Overlap When Split**.
7. Tap the **Overlap When Split** field to set this to **On**.
8. In **Overlapping Width**, set the width, and then select **OK**.

### Related Information

➔ [“Print Settings” on page 144](#)

---

# Sending Faxes Using the Printer

## Basic Fax Sending Operations

Send faxes in color or monochrome (B&W).

### Note:

*When sending a fax in monochrome, you can preview the scanned image on the LCD screen before sending.*

## Faxing

### Sending Fax Using the Control Panel

You can send faxes by entering fax numbers for recipients by using the control panel. The printer automatically dials the recipients and sends the fax.

1. Place the originals.

**Note:**

*You can send up to 100 pages in one transmission; however depending on the remaining amount of memory, you may not be able to send faxes even with less than 100 pages.*

2. Select **Fax** on the home screen.
3. Specify the recipient.

You can send the same monochrome fax to up to 100 recipients including up to 99 groups in **Contacts**. However, a color fax can only be sent to one recipient at a time.

- To enter manually: Select **Keypad**, enter a fax number on the screen displayed, and then tap **OK**.
  - To add a pause (pause for three seconds during dialing), enter a hyphen(-).
  - If you have set an external access code in **Line Type**, enter "#" (hash) instead of the actual external access code at the beginning of the fax number.
- To select from the contacts list: Select **Contacts** and add a check mark to a contact. If the recipients you want to send has not registered in **Contacts** yet, you can register the recipient first by selecting **Add Entry**.
- To select from the sent fax history: Select **Recent**, and then select a recipient.

**Note:**

- When **Direct Dialing Restrictions** in **Security Settings** is set to **On**, you can only select fax recipients from the contacts list or the sent fax history. You cannot manually enter a fax number.

To delete recipients you entered, display the list of recipients by tapping on the field of a fax number or the number of recipients on the LCD screen, select the recipient from the list, and then select **Remove**.

4. Select the **Fax Settings** tab, and then make settings such as the resolution and the sending method as necessary.
5. Select the **Recipient** tab, and then send the fax.

- To send without checking the scanned document image: Tap .
- To scan, check the scanned document image, and then send (when sending a fax in monochrome only): Select **Preview** on the **Recipient** tab.  
To send the fax as is, select **Start Sending**. Otherwise, cancel the preview by selecting **Cancel**, and then go to step 3.

- : Moves the screen in the direction of the arrows.

- : Reduces or enlarges.

- : Moves to the previous or the next page.

## Faxing

### Note:

- ❑ You cannot send the fax in color after previewing.
- ❑ When **Direct Send** is enabled, you cannot preview.
- ❑ When the preview screen is left untouched for 20 seconds, the fax is sent automatically.
- ❑ The image quality of a sent fax may be different from what you previewed depending on the capability of the recipient machine.

6. When sending is complete, remove the originals.

### Note:

- ❑ If the fax number is busy or a problem occurs, the printer automatically redials twice after one minute.
- ❑ To cancel sending, tap .
- ❑ It takes longer to send a fax in color because the printer performs scanning and sending simultaneously. While the printer is sending a fax in color, you cannot use the other features.

### Related Information

- ➔ [“Placing Originals” on page 49](#)
- ➔ [“Menu Options for Faxing” on page 141](#)
- ➔ [“Managing Contacts” on page 53](#)

## Sending Faxes Dialing from the External Phone Device

You can send a fax by dialing using the connected telephone when you want to talk over the phone before sending a fax, or when the recipient's fax machine does not switch to the fax automatically.

1. Place the originals.  
You can send up to 100 pages in one transmission.
2. Pick up the handset of the connected telephone, and then dial the recipient's fax number using the phone.

### Note:

*When the recipient answers the phone, you can talk with the recipient.*

3. Select **Fax** on the home screen.
4. Select the **Fax Settings** tab, and then make settings such as the resolution and the sending method as necessary.
5. When you hear a fax tone, tap , and then hang up the handset.

### Note:

*When a number is dialed using the connected telephone, it takes longer to send a fax because the printer performs scanning and sending simultaneously. While sending the fax, you cannot use the other features.*

6. When sending is complete, remove the originals.

### Related Information

- ➔ [“Placing Originals” on page 49](#)
- ➔ [“Fax Settings” on page 141](#)

## Various Ways of Sending Faxes

### Sending Many Pages of a Monochrome Document (Direct Send)

When sending a fax in monochrome, the scanned document is temporarily stored in the printer's memory. Therefore, sending a lot of pages may cause the printer to run out of memory and stop sending the fax. You can avoid this by enabling the **Direct Send** feature, however, it takes longer to send the fax because the printer performs scanning and sending simultaneously. You can use this feature when there is only one recipient.

Select **Fax** on the home screen, select the **Fax Settings** tab, and then tap **Direct Send** to set this to **On**.

#### Related Information

- ➔ [“Placing Originals” on page 49](#)
- ➔ [“Fax Settings” on page 141](#)

### Sending Faxes at a Specified Time (Send Fax Later)

You can set to send a fax at a specified time. Only monochrome faxes can be sent when the time to send is specified.

1. Select **Fax** on the home screen.
2. Specify the recipient.
3. Select the **Fax Settings** tab, and then select **Send Fax Later**.
4. Tap the **Send Fax Later** field to set this to **On**.
5. Select the **Time** field, enter the time you want to send the fax, and then select **OK**.
6. Select **OK** to apply the settings.

**Note:**

*You cannot send another fax until the fax has been sent at the specified time. If you want to send another one, you need to cancel the scheduled fax by selecting **Fax** on the home screen, and then deleting it.*

#### Related Information

- ➔ [“Placing Originals” on page 49](#)
- ➔ [“Sending Fax Using the Control Panel” on page 124](#)
- ➔ [“Fax Settings” on page 141](#)

### Sending a Fax with a Selected Header

You can send a fax with sender information that is suitable for the recipient. You need to register multiple headers of sender information in advance in the printer by following the steps below.

## Faxing

### **Registering Multiple Headers for Sending Faxes**

You can register up to 21 fax headers as sender information.

1. Select **Settings** on the home screen.
2. Select **General Settings > Fax Settings > Basic Settings**.
3. Select **Header**, tap the **Your Phone Number** field, enter your phone number, and then tap **OK**.
4. Select one of the boxes under the **Fax Header** list, enter the fax header information, and then tap **OK**.

### **Related Information**

➔ [“Basic Settings” on page 146](#)

### **Sending a Fax with a Selected Header**

When you send a fax, you can select header information for the recipient. To use this feature, you must register multiple headers in advance.

1. Select **Fax** on the home screen.
2. Select **Fax Settings > Add Sender Information**.
3. Select where you want to add your sender information.
  - Off**: Sends a fax with no header information.
  - Outside of Image**: Sends a fax with header information in the top white margin of the fax. This keeps the header from overlapping with the scanned image, however, the fax received by the recipient may be printed across two sheets depending on the size of the originals.
  - Inside of Image**: Sends a fax with header information approximately 7 mm lower than the top of the scanned image. The header may overlap with the image, however, the fax received by the recipient will not be split into two documents.
4. Select the **Fax Header** field, and then select the header you want to use.
5. Select one of the **Additional Information** options as necessary.
6. Select **OK** to apply the settings.

### **Related Information**

➔ [“Fax Settings” on page 141](#)

### **Sending Different Size Documents Using ADF (ADF Continuous Scan)**

If you place different sized originals in the ADF, all of the originals are sent at the largest size among them. You can send them in their original sizes by sorting and placing them by size, or placing them one by one.

Before placing originals, make the following setting.

Select **Fax** on the home screen, select the **Fax Settings** tab, and then tap **ADF Continuous Scan** to set this to **On**.

The printer stores the scanned documents, and sends as one document.

**Note:**

If you leave the printer untouched for 20 seconds after prompted to set the next originals, the printer stops storing and starts sending the document.

---

## Receiving Faxes on the Printer

### Setting Receive Mode

You can make a **Receive Mode** using **Fax Setting Wizard**. When making fax setting at the first time, we recommend you to use the **Fax Setting Wizard**. If you want to change only the **Receive Mode**, follow the instruction below.

1. Select **Settings** on the home screen.
2. Select **General Settings** > **Fax Settings** > **Basic Settings** > **Receive Mode**.
3. Select the **Receive Mode** depending on your use.

**Important:**

If a phone is not connected, you must select **Auto**.

- Using the phone line only for faxes:

Select **Auto**.

Automatically switches to receive faxes when the number of rings you set in **Rings to Answer** are complete.

**Note:**

We recommend setting **Rings to Answer** to as low a number as possible.

- Using one phone line for phone calls and faxes (mainly for faxing):

Select **Auto**.

Automatically switches to receive faxes when the number of rings you set in the **Rings to Answer** are reached.

**Note:**

You can make a voice call if you hang up the phone within the number of rings set in **Rings to Answer**.

- Using one phone line for phone calls and faxes (mainly for phonecalls):

Select **Manual**.

You can answer a phone call with an external phone device. When faxing, you can start receiving faxes using the printer's control panel.

**Note:**

When making **Remote Receive** settings, you can start fax receiving faxes using only operations on the connected phone.

### Related Information

- ➔ [“Making Basic Fax Settings Using the Fax Setting Wizard” on page 120](#)
- ➔ [“Receiving Faxes Manually” on page 129](#)
- ➔ [“Receiving Faxes Using a Connected Telephone \(Remote Receive\)” on page 129](#)



## Settings for the Answering Machine

You need settings to use an answering machine.

- ❑ Set the **Receive Mode** of the printer to **Auto**.
- ❑ Set the **Rings to Answer** setting of the printer to a higher number than the number of rings for the answering machine. Otherwise, the answering machine cannot receive voice calls to record voice messages. See the manuals that came with the answering machine for its settings.

The **Rings to Answer** setting may not be displayed depending on the region.

### Related Information

➔ [“Basic Settings” on page 146](#)

## Various Ways of Receiving Faxes

### Receiving Faxes Manually

When you connect a telephone and set the **Receive Mode** setting of the printer to **Manual**, follow the steps below to receive faxes.

1. When the telephone rings, pick up the handset.
2. When you hear a fax tone, select **Fax** on the home screen of the printer.

**Note:**

*If you enable the **Remote Receive** feature, you can start receiving a fax just by using the connected telephone.*

3. Tap **Send/Receive**.
4. Select **Receive**.
5. Tap , and then hang up the handset.

### Related Information

➔ [“Receiving Faxes Using a Connected Telephone \(Remote Receive\)” on page 129](#)

➔ [“Saving Received Faxes in the Inbox” on page 131](#)

### Receiving Faxes Using a Connected Telephone (Remote Receive)

To receive a fax manually, you need to operate the printer after you pick up the handset of the telephone. By using the **Remote Receive** feature, you can start receiving a fax just by operating the phone.

The **Remote Receive** feature is available for telephones that support tone dialing.

### Related Information

➔ [“Receiving Faxes Manually” on page 129](#)

## Faxing

### Setting Up Remote Receive

1. Select **Settings** on the home screen.
2. Select **General Settings > Fax Settings > Basic Settings > Remote Receive**.
3. Tap **Remote Receive** field to set this to **On**.
4. Select **Start Code**, enter a two digit code (you can enter 0 to 9, \*, and #), and then tap **OK**.
5. Select **OK** to apply the settings.

### Related Information

➔ [“Basic Settings” on page 146](#)

### Using Remote Receive

1. When the telephone rings, pick up the handset.
2. When you hear a fax tone, enter the start code using the telephone.
3. After confirming that the printer has started receiving the fax, hang up the handset.

## Receiving Faxes by Polling (Polling Receive)

You can receive a fax stored on another fax machine by dialing the fax number. Use this feature to receive a document from a fax information service. However, if the fax information service has an audio guidance feature that you need to follow to receive a document, you cannot use this feature.

### Note:

*To receive a document from a fax information service that uses audio guidance, just dial the fax number using the connected telephone, and operate the phone and the printer following the audio guidance.*

1. Select **Fax** on the home screen.
2. Tap .
3. Tap **Polling Receive** to set this to **On**, and then tap **Close**.
4. Enter the fax number.

### Note:

*When **Security Settings > Direct Dialing Restrictions** is set to **On**, you can only select fax recipients from the contact list or the sent fax history. You cannot manually enter a fax number.*

5. Tap .

### Related Information

➔ [“Sending Faxes Dialing from the External Phone Device” on page 125](#)

## Making Settings for Blocking Junk Faxes

You can block junk faxes.

1. Select **Settings** on the home screen.
2. Select **General Settings > Fax Settings > Basic Settings > Rejection Fax**.
3. Select **Rejection Fax** and then enable the following options.
  - Rejection Number List: Rejects faxes that are in the Rejection Number List.
  - Fax Header Blank: Rejects faxes that have blank header information.
  - Unregistered Contacts: Rejects faxes that have not been registered in the contact list.
4. If you are using the **Rejection Number List**, tap , select **Edit Blocked Number list**, and then edit the list.

### Related Information

➔ [“Basic Settings” on page 146](#)

## Saving of Received Faxes

The printer provides the following features to save received faxes.

- Saving in the printer's inbox
- Saving on a computer

### Note:

- The above features can be used at the same time. If you do use them all at the same time, received documents are saved to the inbox and on a computer.*
- When there are received documents that have not been read or saved yet, the number of the unprocessed jobs is displayed on the  on the home screen.*

### Related Information

- ➔ [“Saving Received Faxes in the Inbox” on page 131](#)
- ➔ [“Receiving Faxes on a Computer” on page 137](#)

## Saving Received Faxes in the Inbox

You can set to save received faxes in the printer's inbox. Up to 100 documents can be saved. If you use this feature, received documents are not automatically printed. You can view them on the printer's LCD screen and print only when needed.

### Note:

*Saving 100 documents may not be possible depending on the usage conditions such as the file size of saved documents, and using of multiple fax saving features at a time.*

### Related Information

- ➔ [“Setting to Save Received Faxes in the Inbox” on page 132](#)

## Faxing

➔ “Checking the Received Faxes on the LCD Screen” on page 132

### Setting to Save Received Faxes in the Inbox

1. Select **Settings** on the home screen.
2. Select **General Settings > Fax Settings > Receive Settings > Fax Output Settings**.
3. If a confirmation message is displayed, confirm it, and then tap **OK**.
4. Select **Save to Inbox**.
5. Tap **Save to Inbox** to set this to **On**.
6. Select **Options when memory is full**, select the option to use when the inbox is full.
  - Receive and print faxes:** The printer prints all received documents that cannot be saved in the Inbox.
  - Reject incoming faxes:** The printer does not answer incoming fax calls.
7. You can set a password for the inbox. Select **Inbox Password Settings**, and then set the password.

**Note:**

You cannot set a password when **Receive and print faxes** is selected.

### Checking the Received Faxes on the LCD Screen

1. Tap on the  on the home screen.

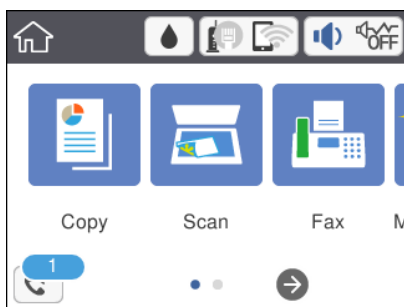

**Note:**

When there are received faxes that have not been read, the number of unread documents is displayed on the  on the home screen.





2. Tap **Open Inbox (XX Unread)**.
3. If the inbox has been password protected, enter the inbox password.
4. Select the fax you want to view from the list.

The contents of the fax are displayed.

- : Moves the screen in the direction of the arrows.
- : Reduces or enlarges.

## Faxing

-  : Rotates the image to the right by 90 degrees.
  -   : Moves to the previous or the next page.
  - To hide the operation icons, tap anywhere on the preview screen except for the icons. Tap again to display the icons.
5. Select whether to print or delete the document you have viewed, and then follow the on-screen instructions.



### **Important:**

*If the printer runs out of memory, receiving and sending faxes is disabled. Delete documents that you have already read or printed.*

### Related Information

- ➔ [“Menu Options for Fax Settings” on page 143](#)

---

## Sending a Fax from a Computer

You can send faxes from the computer by using the FAX Utility and PC-FAX driver.

### **Note:**

*To install the FAX Utility, use the EPSON Software Updater. See Related Information below for details. For Windows users, you can install using the software disc supplied with the printer.*

### Related Information

- ➔ [“Software Update Tools \(EPSON Software Updater\)” on page 174](#)
- ➔ [“Installing the Latest Applications” on page 175](#)

## Sending Documents Created Using an Application (Windows)

By selecting a printer fax from the **Print** menu of an application like Microsoft Word or Excel, you can directly transmit data such as documents, drawings, and tables you have created, with a cover sheet.

### **Note:**

*The following explanation uses Microsoft Word as an example. The actual operation may differ depending on the application you use. For details, see the application's help.*

1. Using an application, create a document to transmit by fax.
2. Click **Print** from the **File** menu.  
The application's **Print** window appears.
3. Select **XXXXXX (FAX)** (where XXXXXX is your printer name) in **Printer**, and then check the settings for fax sending.
  - Specify **1** in **Number of copies**. Fax may not be transmitted correctly if you specify **2** or more.
  - You cannot use functions such as **Print to File** that change the output port.
  - You may transmit up to 100 pages including cover sheet in one fax transmission.

## Faxing

4. Click **Printer Properties** or **Properties** if you want to specify **Paper Size, Orientation, Color, Image Quality,** or **Character Density**. For details, see the PC-FAX driver help.
5. Click **Print**.

**Note:**

When Using FAX Utility for the first time, a window for registering your information is displayed. Enter the necessary information, and then click **OK**. FAX Utility uses **Nickname** to manage fax jobs internally. Other information is automatically added to the cover sheet.

**Recipient Settings** screen of FAX Utility is displayed.

6. Specify a recipient and click **Next**.

- Selecting a recipient (name, fax number and so on) from **PC-FAX Phone Book**:

If the recipient is saved in the phone book, do the steps below.

- ① Click the **PC-FAX Phone Book** tab.
- ② Select the recipient from the list and click **Add**.

- Selecting a recipient (name, fax number and so on) from the contacts on the printer:

If the recipient is saved in the contacts on the printer, do the steps below.

- ① Click the **Contacts on Printer** tab.

Note:

If your printer has a security function that allows administrators to restrict users from changing the printer's fax settings, you may need to enter an administrator password to continue.

- ② Select contacts from the list and click **Add** to proceed to **Add to Recipient** window.
- ③ Select the contacts from the list displayed, and then click **Edit**.
- ④ Add the personal data such as **Company/Corp.** and **Title** as necessary, and then click **OK** to return to the **Add to Recipient** window.
- ⑤ As necessary, select the checkbox of **Register in the PC-FAX Phone Book** to save the contacts to **PC-FAX Phone Book**.
- ⑥ Click **OK**.

- Specifying a recipient (name, fax number and so on) directly:

Do the steps below.

- ① Click the **Manual Dial** tab.
- ② Enter the necessary information.
- ③ Click **Add**.

Furthermore, by clicking **Save to Phone Book**, you can save the recipient in the list under the **PC-FAX Phone Book** tab.

**Note:**

- If your printer's Line Type is set to **PBX** and the access code has been set to use # (hash) instead of entering the exact prefix code, enter # (hash). For details, see Line Type in Basic Settings from related information link below.
- If you have selected **Enter fax number twice** in the **Option settings** on the FAX Utility main screen, you need to enter the same number again when you click **Add** or **Next**.

The recipient is added to the **Recipient List** displayed in the upper part of the window.

## Faxing

### 7. Specify the content of the cover sheet.

➊ To attach a cover sheet, select one of the samples from **Cover Sheet**. Enter the **Subject** and **Message**. Note that there is no function to create an original cover sheet or to add an original cover sheet to the list.

If you do not want to attach a cover sheet, select **No cover sheet** from **Cover Sheet**.

➋ Click **Cover Sheet Formatting** if you want to change the order of the items on the cover sheet. You can select the cover sheet size in **Paper Size**. You can also select a cover sheet at a different size to the document being transmitted.

➌ Click **Font** if you want to change the font or font size used for the text on the cover sheet.

➍ Click **Sender Settings** if you want to change the sender information.

➎ Click **Detailed Preview** if you want to check the cover sheet with the subject and the message you entered.

➏ Click **Next**.

### 8. Check the transmission content and click **Send**.

Make sure the name and fax number of the recipient are correct before transmitting. Click **Preview** to preview the cover sheet and document to transmit.

Once transmission starts, a window displaying the transmission status appears.

#### **Note:**

- To stop transmitting, select the data, and click **Cancel** . You can also cancel using the printer's control panel.
- If an error occurs during transmission, the **Communication Error** window appears. Check the error information and retransmit.
- The Fax Status Monitor screen (the screen mentioned above where you can check the transmission status) is not displayed if **Display Fax Status Monitor During Transmission** is not selected in the **Optional Settings** screen of the FAX Utility main screen.

## Related Information

➔ [“Basic Settings” on page 146](#)

## Sending Documents Created Using an Application (Mac OS)

By selecting a fax-capable printer from the **Print** menu of a commercially available application, you can send data such as documents, drawings, and tables, you have created.

#### **Note:**

The following explanation uses *Text Edit*, a standard Mac OS application as an example.

1. Create the document you want to send by fax in an application.
2. Click **Print** from the **File** menu.  
The application's **Print** window is displayed.
3. Select your printer (fax name) in **Name**, click ▼ to display the detailed settings, check the print settings, and then click **OK**.
4. Make settings for each item.
  - Specify **1** in **Number of copies**. Even if you specify **2** or more, only 1 copy is sent.

## Faxing

- You can send up to 100 pages in one fax transmission.

**Note:**

*The page size of documents you can send is the same as the paper size you can fax from the printer.*

5. Select Fax Settings from the popup menu, and then make settings for each item.

See the PC-FAX driver's help for explanations on each setting item.

Click  at the bottom left of the window to open the PC-FAX driver's help.

6. Select the Recipient Settings menu, and then specify the recipient.

- Specifying a recipient (name, fax number, and so on) directly:

Click the **Add** item, enter the necessary information, and then click . The recipient is added to the Recipient List displayed in the upper part of the window.

If you have selected "Enter fax number twice" in the PC-FAX driver settings, you need to enter the same number again when you click .

If your fax connection line requires a prefix code, enter External Access Prefix.

**Note:**

*If your printer's Line Type is set to **PBX** and the access code has been set to use # (hash) instead of entering the exact prefix code, enter # (hash). For details, see Line Type in Basic Settings from Related Information link below.*

- Selecting a recipient (name, fax number, and so on) from the phone book:

If the recipient is saved in the phone book, click . Select the recipient from the list, and then click **Add > OK**.

If your fax connection line requires a prefix code, enter External Access Prefix.

**Note:**

*If your printer's Line Type is set to **PBX** and the access code has been set to use # (hash) instead of entering the exact prefix code, enter # (hash). For details, see Line Type in Basic Settings from Related Information link below.*

7. Check the recipient settings, and then click **Fax**.

Sending starts.

Make sure the name and fax number of the recipient are correct before transmitting.

**Note:**

- If you click the printer icon in Dock, the transmission status check screen is displayed. To stop sending, click the data, and then click **Delete**.

- If an error occurs during transmission, the **Sending failed** message is displayed. Check the transmission records on the **Fax Transmission Record** screen.

- Mixed paper size documents may not be sent correctly.

### Related Information

- ➔ ["Basic Settings" on page 146](#)



---

## Receiving Faxes on a Computer

You can receive faxes and save them as PDF files to the computer connected to the printer. The FAX Utility comes with features including how to specify a folder to save the faxes. Install the FAX Utility before using this feature.

**Note:**

You can use one of the following methods to install the FAX Utility.

- Using the EPSON Software Updater (application for updating software)
- Using the disc supplied with your printer. (Windows users Only )

**Important:**

- When receiving faxes from the computer, select **Auto** in the printer's fax receiving setting.
- The computer set to receive faxes should always be on. Received documents are saved in the printer's memory temporarily before the documents are saved on the computer. If you turn off the computer, the printer's memory might become full as it cannot send the documents to the computer.
- The number of documents that have been temporarily saved to the printer's memory are displayed on the  on the home screen.
- To read the received faxes, you need to install a PDF viewer such as Adobe Reader in the computer.

**Related Information**

➔ [“Software Update Tools \(EPSON Software Updater\)” on page 174](#)

## Setting to Save a Received Fax on a Computer

You can make received fax settings by using the FAX Utility. Install the FAX Utility on the computer in advance.

For details, see Basic Operations in the FAX Utility help (displayed on the main window).

**Note:**

You can receive faxes and print faxes at the same time.

**Related Information**

➔ [“Application for Configuring Fax Operations and Sending Faxes \(FAX Utility\)” on page 171](#)

## Receiving Faxes on a Computer and Printing from the Printer

As well as making settings to save received faxes on a computer, follow the steps below on the printer.

1. Select **Settings > General Settings > Fax Settings > Receive Settings**.
2. Select **Fax Output Settings > Save to Computer > Yes and Print**.

**Related Information**

➔ [“Setting to Save a Received Fax on a Computer” on page 137](#)

➔ [“Receive Settings” on page 144](#)

## Canceling Received Faxes on the Computer

To cancel saving faxes on the computer, change the settings on the printer.

**Note:**

You can also change the settings using the FAX Utility. However, if there are any faxes that have not been saved to the computer, you cannot change the settings.

1. Select **Settings > General Settings > Fax Settings > Receive Settings**.
2. Select **Fax Output Settings > Save to Computer > No**.

### Related Information

- ➔ [“Application for Configuring Fax Operations and Sending Faxes \(FAX Utility\)” on page 171](#)
- ➔ [“Receive Settings” on page 144](#)

## Checking for New Faxes (Windows)

By setting up a computer to save faxes received by the printer, you can check the processing status of received faxes, and whether or not there are any new faxes using the fax icon on the Windows task bar. By setting up the computer to display a notification when new faxes are received, a notification screen pops up near the Windows system tray, and you can check the new faxes.



**Note:**

- Received fax data saved to the computer is removed from the printer's memory.
- You need Adobe Reader to view the received faxes because they are saved as PDF files.

## Using the Fax Icon on the Task Bar (Windows)

You can check for new faxes and the operation status by using the fax icon displayed on the Windows taskbar.

1. Check the icon.

-  : Standing by.
-  : Checking for new faxes.
-  : Importing new faxes is complete.

2. Right-click the icon, and then click **Open the received fax folder**.

The received fax folder is displayed. Check the date and the sender in the file name, and then open the PDF file.

While the fax icon indicates that it is standing by, you can check for new faxes instantly by selecting **Check new faxes**.

**Note:**

Received faxes are automatically renamed using the following naming format.

YYYYMMDDHHMMSS\_XXXXXXXXXX\_nnnnn (Year/Month/Day/Hour/Minute/Second\_sender's number)

## Faxing

### Using the Notification Window (Windows)

When you set to notify you the new faxes exist, a notification window is displayed near the task bar for each the fax.

1. Check the notification screen displayed on your computer screen.

**Note:**

*The notification screen disappears if no operation is performed for a given length of time. You can change the notification settings such as the display time.*

2. Click anywhere in the notification screen, except for the  button.

The folder you specified to save new faxes opens. Check the date and the sender in the file name, and then open the PDF file.

**Note:**

*Received faxes are automatically renamed using the following naming format.*

*YYYYMMDDHHMMSS\_XXXXXXXXXX\_nnnnn (Year/Month/Day/Hour/Minute/Second\_sender's number)*

### Checking for New Faxes (Mac OS)

You can check for new faxes using one of the following methods. This is available only on computers set to "Save" (save faxes on this computer).

- Open the received fax folder (specified in **Received Fax Output Settings**.)
- Open the Fax Receive Monitor and click **Check new faxes**.
- Notification that new faxes have been received

Select the **Notify me of new faxes via a dock icon** in the **Fax Receive Monitor > Preferences** in the FAX Utility, the fax receive monitor icon on the Dock jumps to notify you that new faxes have arrived.

### Open the Received Fax Folder from Received Fax Monitor (Mac OS)

You can open the save folder from the computer specified to receive faxes when selecting "Save" (save faxes on this computer).

1. Click the received fax monitor icon on the Dock to open **Fax Receive Monitor**.
2. Select the printer and click **Open folder**, or double click the printer name.
3. Check the date and the sender in the file name, and then open the PDF file.

**Note:**

*Received faxes are automatically renamed using the following naming format.*

*YYYYMMDDHHMMSS\_XXXXXXXXXX\_nnnnn (Year/Month/Day/Hour/Minute/Second\_sender's number)*

*Information sent from the sender is displayed as the sender's number. This number may not be displayed depending on the sender.*

---

## Using Other Faxing Features

### Printing Fax Report and List

#### Printing Fax Report Manually

1. Select **Fax** on the home screen.
2. Tap  (More).
3. Select **Fax Report**.
4. Select the report you want to print, and then follow the on-screen instructions.

**Note:**

You can change the report format. From the home screen, select **Settings > General Settings > Fax Settings > Report Settings**, and then change the **Attach Fax image to report** or **Report Format** settings.

#### Related Information

- ➔ [“More” on page 142](#)
- ➔ [“Report Settings” on page 145](#)

### Setting Up to Print Fax Reports Automatically

You can make settings to print the following fax reports automatically.

#### Transmission Report

From the home screen, select **Fax > Fax Settings > Transmission Report**, and then select **Print** or **Print on Error**.

#### Fax Log

From the home screen, select **Settings > General Settings > Fax Settings > Report Settings > Fax Log Auto Print**, and then select **On(Every 30)** or **On(Time)**.

#### Related Information

- ➔ [“Menu Options for User Settings” on page 147](#)
- ➔ [“Report Settings” on page 145](#)

### Setting Security for Faxing

You can make security settings to prevent sending a fax to the wrong recipient, or prevent received documents from being leaked or lost. You can also delete backed-up fax data.

1. Select **Settings** on the home screen.

## Faxing

2. Select **General Settings > Fax Settings > Security Settings**.
3. Select the menu, and then make the settings.

### Related Information

➔ [“Security Settings” on page 147](#)

---

## Menu Options for Faxing

### Recipient

Select the menus on the control panel as described below.

#### Fax > Recipient

##### Keypad:

Manually enter a fax number.

##### Contacts:

Select a recipient from the contacts list. You can also add or edit a contact.

##### Recent:

Select a recipient from the sent fax history. You can also add the recipient to the contacts list.

### Fax Settings

Select the menus on the control panel as described below.

#### Fax > Fax Settings

##### Scan Settings:

###### Original Size (Glass)

Select the size and orientation of the original you placed on the scanner glass.

###### Color Mode

Select whether to scan in color or in monochrome.

###### Resolution

Select the resolution of the outgoing fax.

###### Density

Sets the density of the outgoing fax.

###### Remove Background

Detects the paper color (background color) of the original document, and removes or lightens the color. Depending on the darkness and vividness of the color, it may not be removed or lightened

## Faxing

### ADF Continuous Scan

When sending a fax from the ADF, you cannot add originals in the ADF after starting scanning. If you place different sized originals in the ADF, all of the originals are sent at the largest size among them. Enable this option so that the printer asks if you want to scan another page after an original in the ADF has finished scanning. Then you can sort and scan your originals by size and send them as a single fax.

### Fax Send Settings:

#### Direct Send

Sends monochrome faxes to a single recipient as soon as the connection is made, without saving the scanned image to memory. If you do not enable this option, the printer starts the transmission after saving the scanned image to memory and may cause a memory full error when sending many pages. By using this option, you can avoid the error, but it takes longer to send the fax. You cannot use this option when sending a fax to multiple recipients.

#### Send Fax Later

Sends a fax at a time you specified. Only a monochrome fax is available when using this option.

#### Add Sender Information

##### Add Sender Information:

Select the position where you want to include the header information (sender name and fax number) in the outgoing fax, or not to include the information.

- **Off:** Sends a fax with no header information.

- **Outside of Image:** Sends a fax with header information in the top white margin of the fax. This keeps the header from overlapping with the scanned image, however, the fax received by the recipient may be printed across two sheets depending on the size of the originals.

- **Inside of Image:** Sends a fax with header information approximately 7 mm lower than the top of the scanned image. The header may overlap with the image, however, the fax received by the recipient will not be split into two documents.

##### Fax Header:

Select the header for the recipient. To use this feature, you should register multiple headers in advance.

##### Additional Information:

Select the information you want to add. You can select one from **Your Phone Number** and **Destination List**.

#### Transmission Report

Prints a transmission report automatically after you send a fax. Select **Print on Error** to print a report only when an error occurs. If **Settings > General Settings > Fax Settings > Report Settings > Attach Fax image to report** is set, an image of the document is printed with the report.

#### Clear All Settings

Restores all settings in **Fax Settings** to their defaults.

## More

Select the menus on the control panel as described below.

**Fax** >  (More)

## Faxing

### Transmission History:

You can check the history of sent or received fax jobs.

### Fax Report:

Last Transmission

Prints a report for the previous fax that was sent or received through polling.

Fax Log

Prints a transmissions report. You can set to print this report automatically using the following menu.

**Settings > General Settings > Fax Settings > Report Settings > Fax Log Auto Print**

Fax Settings List

Prints the current fax settings.

Protocol Trace

Prints a detailed report for the previous fax that was sent or received.

### Polling Receive:

Connects to the fax number you entered and receives a fax stored on the fax machine. You can use this option for receiving a fax from a fax information service.

### Inbox:

Opens the inbox where the received faxes are stored.

### Reprint Faxes:

Prints the received faxes again.

### Fax Settings:

Opens **Fax Settings**. You can also access this screen by selecting **Settings** on the home screen, and then selecting **General Settings > Fax Settings**. For more details, see the page that describes the **Fax Settings** feature.

### Related Information

➔ [“Menu Options for Fax Settings” on page 143](#)

---

## Menu Options for Fax Settings

Select the menus on the control panel as described below.

**Settings > General Settings > Fax Settings**

### Check Fax Connection

Select the menus on the control panel as described below.

**Settings > General Settings > Fax Settings > Check Fax Connection**

## Faxing

Checks if the printer is connected to the phone line and ready for fax transmission, and prints the check result on A4 size plain paper.

### Fax Setting Wizard

Select the menus on the control panel as described below.

**Settings > General Settings > Fax Settings > Fax Setting Wizard**

Select to make basic fax settings by following the on-screen instructions. For details, see the page that describes basic fax settings.

### Receive Settings

Select the menus on the control panel as described below.

**Settings > General Settings > Fax Settings > Receive Settings**

### Fax Output Settings

You can set to save received documents in the inbox or on a computer. Select the menus on the control panel as described below.

Save to Inbox:

Saves received faxes in the printer's inbox.

Save to Computer:

Converts received documents into PDF format and saves them on a computer connected to the printer.

### Print Settings

Select the menus on the control panel as described below.

Auto Reduction:

Reduces large received documents to fit on the paper in the paper source. Reducing may not always be possible depending on the received data. If this is turned off, large documents are printed at their original size on multiple sheets, or a blank second page may be ejected.

Split Page Settings:

Make split page settings when the size of the received document is larger than the size of the paper loaded in the printer.

Auto Rotation:

Rotates faxes received as landscape-orientated, A5 size documents so that they are printed on the correct paper size. This setting is applied when the paper size setting is set to A5. Check the following menu.

**Settings > General Settings > Printer Settings > Paper Source Settings > Paper Setting**



## Faxing

### Add Reception Information:

Prints reception information in the header of the received fax, even if the sender does not set the header information. The reception information includes the received date and time, sender's ID, reception ID (such as "#001"), and page number (such as "P1"). When **Split Page Settings** is enabled, the split page number is also included.

### 2-Sided:

You can print multiple pages of received documents on both sides of the paper.

### Print Start Timing:

Select options to start printing the received documents.

**All Pages Received:** After receiving all of the pages, printing starts from the first page.

**First Page Received:** Starts printing when the first page is received, and then prints in order as the pages are received. If the printer cannot start printing, such as when it is printing other jobs, the printer starts printing received pages as a batch when it is available.

### Collation Stack:

Prints received documents from the last page (print in descending order) so that the printed documents are stacked in the correct page order. When the printer is running low on memory, this feature may not be available.

### Print Suspend Time:

Saves documents received during the specified time period in the printer's memory without printing them. At the time specified to restart printing, the documents are automatically printed. This feature can be used for noise prevention at night or to prevent confidential documents from being disclosed while you are away. Before using this feature, make sure there is enough free memory.

### Quiet Mode:

Reduces the noise the printer makes when printing faxes, however, print speed may be reduced.

## Report Settings

Select the menu on the control panel as described below.

### Settings > General Settings > Fax Settings > Report Settings

#### Fax Log Auto Print:

Prints the fax log automatically. Select **On(Every 30)** to print a log every time 30 fax jobs are completed. Select **On(Time)** to print the log at a specified time. However, if the number of fax jobs exceeds 30, the log is printed before the specified time.

#### Attach Fax image to report:

Prints a **Transmission Report** with an image of the first page of the sent document. Select **On(Large Image)** to print the upper part of the page without reducing. Select **On(Small Image)** to print the entire page reducing it to fit onto the report.

#### Report Format:

Select a format for fax reports. Select **Detail** to print with error codes.

## Faxing

### Basic Settings

Select the menus on the control panel as described below.

#### Settings > General Settings > Fax Settings > Basic Settings

##### Fax Speed:

Select the fax transmission speed. We recommend selecting **Slow(9,600bps)** when a communication error occurs frequently, when sending/receiving a fax to/from abroad, or when you are using an IP (VoIP) phone service.

##### ECM:

Automatically corrects errors in the fax transmission (Error Correction Mode), mostly caused by telephone line noise. If this is disabled, you cannot send or receive documents in color.

##### Dial Tone Detection:

Detects a dial tone before starting to dial. If the printer is connected to a PBX (Private Branch Exchange) or digital phone line, the printer may fail to start dialing. In this situation, change the **Line Type** setting to **PBX**. If this does not work, disable this feature. However, disabling this feature may drop the first digit of a fax number and send the fax to the wrong number.

##### Line Type:

Select the line type to which you have connected the printer. When using the printer in an environment that uses extensions and requires an external access code, such as 0 and 9, to get an outside line, select **PBX** and register the access code. Once you have registered the access code, enter # (hash) instead of the access code when sending a fax to an outside fax number. For an environment that uses a DSL modem or terminal adapter, setting to **PBX** is also recommended.

##### Header:

Enter your sender name and fax number. These appear as a header on outgoing faxes. You can enter up to 40 characters for your name, and up to 20 digits for your fax number.

##### Receive Mode:

Select the receive mode.

##### DRD:

If you have subscribed to a distinctive ring service from your telephone company, select the ring pattern to be used for incoming faxes. The distinctive ring service, offered by many telephone companies (the service name differs by company), allows you to have several phone numbers on one phone line. Each number is assigned different ring pattern. You can use one number for voice calls and another for fax calls. Depending on the region, this option may be **On** or **Off**.

##### Rings to Answer:

Select the number of rings that must occur before the printer automatically receives a fax.

##### Remote Receive:

When you answer an incoming fax call on a phone connected to the printer, you can start receiving the fax by entering the code using the phone.

## Faxing

### Rejection Fax:

Select options to reject junk faxes.

## Security Settings

Select the menus on the control panel as described below.

### **Settings > General Settings > Fax Settings > Security Settings**

#### Direct Dialing Restrictions:

Off

Enables the manual entry of recipient's fax numbers.

On

Disables the manual entry of recipient's fax numbers allowing the operator to select recipients only from the contacts list or sent history.

Enter Twice

Requires the operator to enter the fax number again when the number was manually entered.

#### Confirm Address List:

Displays a recipient confirmation screen before starting the transmission.

#### Backup Data Auto Clear:

To prepare for an unexpected power off due to an electricity failure or an incorrect operation, the printer temporarily stores backup copies of sent and received documents in its memory. Enable this option to automatically erase the backups when sending or receiving a document completes successfully and the backups become unnecessary.

#### Clear Backup Data:

Erases all backup copies temporarily stored in the printer's memory. Run this before you give the printer to someone else or dispose of it.

---

## Menu Options for User Settings

Select the menus on the control panel as described below.

### **Settings > User Settings > Fax**

The settings made in this menu become your default settings for sending faxes. For explanations on the setting items, see the **Fax Settings** in the **Fax** menu.

#### Related Information

➔ [“Fax Settings” on page 141](#)

---

## Menu Options for Inbox



(Inbox):

Tapping this opens the Inbox where the received faxes are stored. When there are received faxes that have not been read, the number of unread documents is displayed on the .

# Replacing Ink Cartridges and Other Consumables

---

## Checking the Status of the Remaining Ink and the Maintenance Box

You can check the approximate ink levels and the approximate service life of the maintenance box from the control panel or the computer.

### Checking the Status of the Remaining Ink and the Maintenance Box - Control Panel

Select  on the home screen.

### Checking the Status of the Remaining Ink and the Maintenance Box - Windows

1. Access the printer driver window.
2. Click **EPSON Status Monitor 3** on the **Maintenance** tab.

**Note:**

*If EPSON Status Monitor 3 is disabled, click **Extended Settings** on the **Maintenance** tab, and then select **Enable EPSON Status Monitor 3**.*

#### Related Information

➔ [“Accessing the Printer Driver” on page 64](#)

### Checking the Status of the Remaining Ink and the Maintenance Box - Mac OS

1. Select **System Preferences** from the  menu > **Printers & Scanners** (or **Print & Scan**, **Print & Fax**), and then select the printer.
2. Click **Options & Supplies** > **Utility** > **Open Printer Utility**.
3. Click **EPSON Status Monitor**.

## Replacing Ink Cartridges and Other Consumables

### Ink Cartridge Codes

Epson recommends the use of genuine Epson ink cartridges. Epson cannot guarantee the quality or reliability of non-genuine ink. The use of non-genuine ink may cause damage that is not covered by Epson's warranties, and under certain circumstances, may cause erratic printer behavior. Information about non-genuine ink levels may not be displayed.

The following are the codes for genuine Epson ink cartridges.

**Note:**

- Not all cartridges are available in all regions.
- Ink cartridge codes may vary by location. For the correct codes in your area, contact Epson support.

#### For Europe

Icon	BK: Black	C: Cyan	M: Magenta	Y: Yellow
Binoculars 	502 502XL*	502 502XL*	502 502XL*	502 502XL*

\* "XL" indicates a large cartridge.

Visit the following website for information on Epson's ink cartridge yields.

<http://www.epson.eu/pageyield>

#### For Australia and New Zealand

BK: Black	C: Cyan	M: Magenta	Y: Yellow
202 202XL*	202 202XL*	202 202XL*	202 202XL*

\* "XL" indicates a large cartridge.

#### For Asia

BK: Black	C: Cyan	M: Magenta	Y: Yellow
03C 03D*	03C	03C	03C

\* "D" indicates a large cartridge.

#### Related Information

➔ [“Technical Support Web Site” on page 223](#)

---

## Ink Cartridge Handling Precautions

Read the following instructions before replacing ink cartridges.

### Handling precautions

- Store ink cartridges at normal room temperature and keep them away from direct sunlight.
- Epson recommends using the ink cartridge before the date printed on the package.
- For best results, use up ink cartridge within six months of opening the package.
- For best results, store ink cartridge packages with their bottom down.
- After bringing an ink cartridge inside from a cold storage site, allow it to warm up at room temperature for at least three hours before using it.
- Do not open the ink cartridge package until you are ready to install it in the printer. The cartridge is vacuum packed to maintain its reliability. If you leave a cartridge unpacked for a long time before using it, normal printing may not be possible.
- Be careful not to break the hooks on the side of the ink cartridge when you remove it from the package.
- You must remove the yellow tape from the cartridge before installing it; otherwise, print quality may decline or you may not be able to print. Do not remove or tear the label on the cartridge; this can cause leakage.

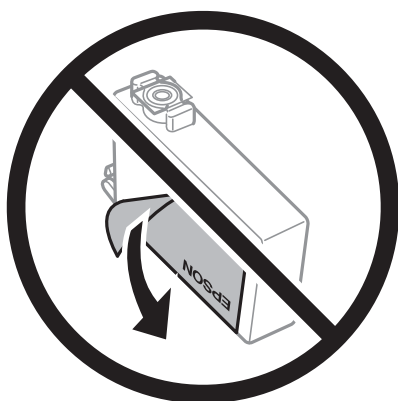

- Do not remove the transparent seal from the bottom of the cartridge; otherwise, the cartridge may become unusable.

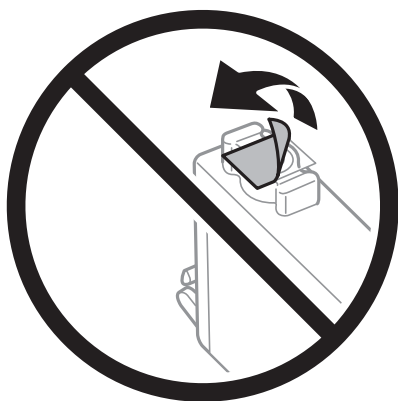

## Replacing Ink Cartridges and Other Consumables

- ❑ Do not touch the sections shown in the illustration. Doing so may prevent normal operation and printing.



- ❑ Install all ink cartridges; otherwise you cannot print.
- ❑ Do not replace ink cartridges with the power off. Do not move the print head by hand; otherwise, you may damage the printer.
- ❑ Do not turn off the printer during ink charging. If the ink charging is incomplete, you may not be able to print.
- ❑ Do not leave the printer with the ink cartridges removed or do not turn off the printer during cartridge replacement. Otherwise, ink remaining in the print head nozzles will dry out and you may not be able to print.
- ❑ If you need to remove an ink cartridge temporarily, make sure you protect the ink supply area from dirt and dust. Store the ink cartridge in the same environment as the printer, with the ink supply port facing down or sideways. Do not store ink cartridges with the ink supply port facing up. Because the ink supply port is equipped with a valve designed to contain the release of excess ink, there is no need to supply your own covers or plugs.
- ❑ Removed ink cartridges may have ink around the ink supply port, so be careful not to get any ink on the surrounding area when removing the cartridges.
- ❑ This printer uses ink cartridges equipped with a green chip that monitors information such as the amount of remaining ink for each cartridge. This means that even if the cartridge is removed from the printer before it is expended, you can still use the cartridge after reinserting it back into the printer. However, when reinserting a cartridge, some ink may be consumed to guarantee printer performance.
- ❑ For maximum ink efficiency, only remove an ink cartridge when you are ready to replace it. Ink cartridges with low ink status may not be used when reinserted.
- ❑ To ensure you receive premium print quality and to help protect your print head, a variable ink safety reserve remains in the cartridge when your printer indicates to replace the cartridge. The yields quoted for you do not include this reserve.
- ❑ Although the ink cartridges may contain recycled materials, this does not affect printer function or performance.
- ❑ Specifications and appearance of the ink cartridge are subject to change without prior notice for improvement.
- ❑ Do not disassemble or remodel the ink cartridge, otherwise you may not be able to print normally.
- ❑ You cannot use the cartridges that came with the printer for the replacement.
- ❑ Quoted yields may vary depending on the images that you are printing, the paper type that you are using, the frequency of your prints and environmental conditions such as temperature.

### Ink consumption

- ❑ To maintain optimum print head performance, some ink is consumed from all cartridges during maintenance operations such as print head cleaning. Ink may also be consumed when you turn on the printer.



## Replacing Ink Cartridges and Other Consumables

- ❑ When printing in monochrome or grayscale, color inks instead of black ink may be used depending on the paper type or print quality settings. This is because a mixture of color inks is used to create black.
- ❑ The ink in the ink cartridges supplied with your printer is partly used during initial setup. In order to produce high quality printouts, the print head in your printer will be fully charged with ink. This one-off process consumes a quantity of ink and therefore these cartridges may print fewer pages compared to subsequent ink cartridges.

---

## Replacing Ink Cartridges

When a message is displayed prompting you to replace the ink cartridges, select **How To** and then view the animations displayed on the control panel to learn how to replace the ink cartridges.

If you need to replace the ink cartridges before they are expended, select **Maintenance > Ink Cartridge Replacement** on the home screen, and then follow the on-screen instructions. Select **How To** for details.

**Caution:**

*Be careful not to trap your hand or fingers when opening or closing the scanner unit. Otherwise you may be injured.*

**Note:**

*You can continue printing even after the printer indicates that ink is low. However, prepare new ink cartridges as soon as possible.*

**Related Information**

- ➔ [“Ink Cartridge Codes” on page 150](#)
- ➔ [“Ink Cartridge Handling Precautions” on page 151](#)

---

## Maintenance Box Code

Epson recommends the use of a genuine Epson maintenance box.

Maintenance box code: T04D1

**Important:**

*Once a maintenance box has been installed in a printer it cannot be used with other printers.*

---

## Maintenance Box Handling Precautions

Read the following instructions before replacing the maintenance box.

- ❑ Do not touch the green chip on the side of the maintenance box. Doing so may prevent normal operation and printing.
- ❑ Do not drop the maintenance box or subject it to strong shocks.
- ❑ Do not replace the maintenance box during printing; otherwise, ink may leak.
- ❑ Do not remove the maintenance box and its cover except when replacing the maintenance box; otherwise ink may leak.

## Replacing Ink Cartridges and Other Consumables

- When the cover cannot be reattached, the maintenance box may not be installed correctly. Remove the maintenance box, and re-install it.
- Do not tilt the used maintenance box until after it is sealed in the plastic bag; otherwise ink may leak.
- Do not touch the openings in the maintenance box as you may get smeared with ink.
- Do not reuse a maintenance box which has been removed and left detached for a long period. Ink inside the box will have solidified and no more ink can be absorbed.
- Keep the maintenance box out of direct sunlight.
- Do not store the maintenance box in high or freezing temperatures.

---

## Replacing a Maintenance Box

In some print cycles a very small amount of surplus ink may be collected in the maintenance box. To prevent ink leakage from the maintenance box, the printer is designed to stop printing when the absorbing capacity of the maintenance box has reached its limit. Whether and how often this is required will vary according to the number of pages you print, the type of material that you print and the number of cleaning cycles that the printer performs.

When a message is displayed prompting you to replace the maintenance box, refer to the animations displayed on the control panel. The need for replacement of the box does not mean that your printer has ceased to operate in accordance with its specifications. The Epson warranty does not cover the cost of this replacement. It is a user-serviceable part.

**Note:**

*When it is full, you cannot print until the maintenance box is replaced to avoid ink leakage. However, non-printing features are available.*

### Related Information

- ➔ [“Maintenance Box Code” on page 153](#)
- ➔ [“Maintenance Box Handling Precautions” on page 153](#)

---

## Temporarily Printing with Black Ink

When color ink is expended and black ink still remains, you can use the following settings to continue printing for a short time using only black ink.

- Type of paper: plain papers, Envelope
- Color: B&W or Grayscale
- Borderless: Not selected
- EPSON Status Monitor 3: Enabled (When printing from the printer driver on Windows.)

Because this feature is only available for approximately five days, replace the expended ink cartridge as soon as possible.

**Note:**

- If EPSON Status Monitor 3 is disabled, access the printer driver, click **Extended Settings** on the **Maintenance** tab, and then select **Enable EPSON Status Monitor 3**.*
- The available period varies depending on the usage conditions.*

## Replacing Ink Cartridges and Other Consumables

### Temporarily Printing with Black Ink - Control Panel

1. When a message is displayed prompting you to replace the ink cartridges, select **Proceed**.  
A message is displayed telling you that you can temporarily print with black ink.
2. Check the message, and then select **Proceed**.
3. If you want to print in monochrome, select **No, remind me later**.  
The ongoing job is canceled.
4. Now you can copy originals or print received faxes on plain paper in monochrome. Select the feature you want to use on the home screen.

**Note:**

*Borderless copying is not available.*

### Temporarily Printing with Black Ink - Windows

1. When the following window is displayed, cancel printing.

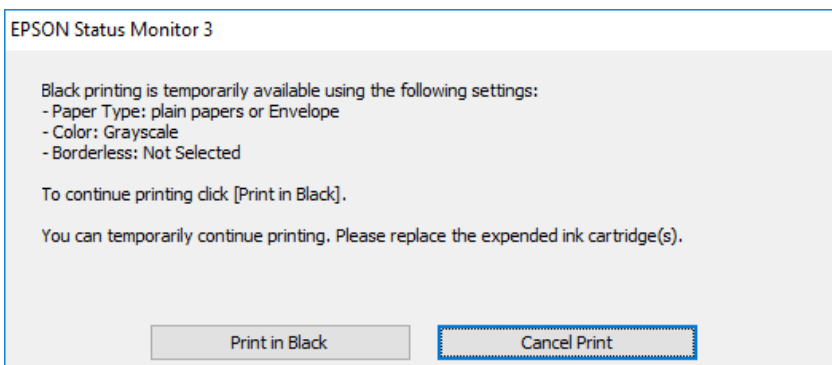
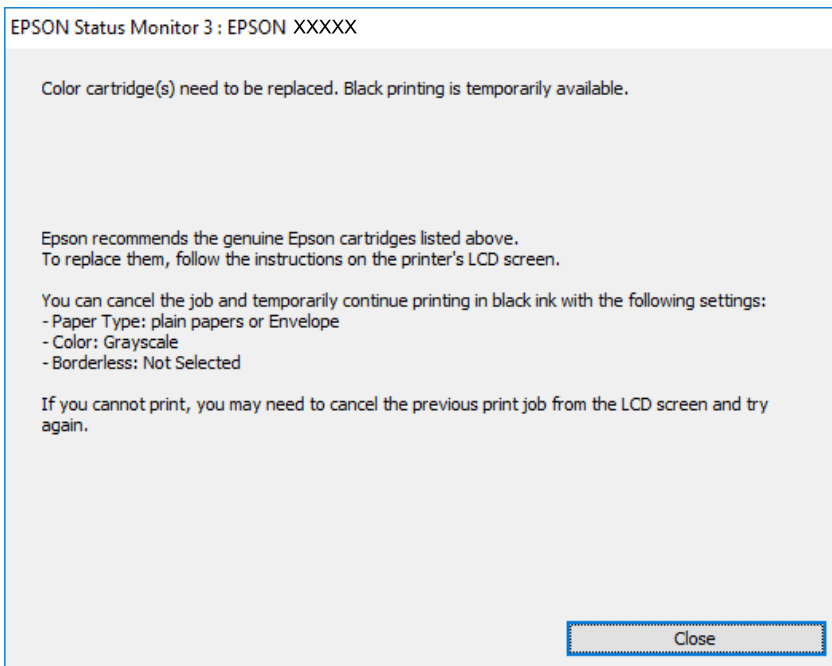

## Replacing Ink Cartridges and Other Consumables

**Note:**

*If you cannot cancel printing from the computer, cancel using the printer's control panel.*

2. Access the printer driver window.
3. Clear **Borderless** on the **Main** tab.
4. Select **plain papers** or **Envelope** as the **Paper Type** setting on the **Main** tab.
5. Select **Grayscale**.
6. Set the other items on the **Main** and **More Options** tabs as necessary, and then click **OK**.
7. Click **Print**.
8. Click **Print in Black** in the window displayed.

### Related Information

- ➔ [“Canceling” on page 80](#)
- ➔ [“Loading Paper in the Paper Cassette” on page 45](#)
- ➔ [“Printing Basics” on page 64](#)

## Temporarily Printing with Black Ink - Mac OS

**Note:**

*To use this feature through a network, connect with **Bonjour**.*

1. Click the printer icon in the **Dock**.
2. Cancel the job.

**Note:**

*If you cannot cancel printing from the computer, cancel using the printer's control panel.*

3. Select **System Preferences** from the  menu > **Printers & Scanners** (or **Print & Scan**, **Print & Fax**), and then select the printer. Click **Options & Supplies** > **Options** (or **Driver**).
4. Select **On** as the **Permit temporary black printing** setting.
5. Access the print dialog.
6. Select **Print Settings** from the pop-up menu.
7. Select any paper size except for a borderless size as the **Paper Size** setting.
8. Select **plain papers** or **Envelope** as the **Media Type** setting.
9. Select **Grayscale**.
10. Set the other items as necessary.
11. Click **Print**.

## Replacing Ink Cartridges and Other Consumables

### Related Information

- ➔ “Canceling Printing” on page 80
- ➔ “Loading Paper in the Paper Cassette” on page 45
- ➔ “Printing Basics” on page 82

---

## Conserving Black Ink when the Black Ink Is Low (for Windows Only)

When black ink is running low and there is enough color ink remaining, you can use a mixture of color inks to create black. You can continue printing while preparing a replacement black ink cartridge.

This feature is only available when you select the following settings in the printer driver.

- Paper Type: **plain papers**
- Quality: **Standard**
- EPSON Status Monitor 3: Enabled

#### Note:

- If **EPSON Status Monitor 3** is disabled, access the printer driver, click **Extended Settings** on the **Maintenance** tab, and then select **Enable EPSON Status Monitor 3**.
- Composite black looks slightly different from pure black. In addition, the print speed is reduced.
- To maintain the quality of the print head, black ink is also consumed.

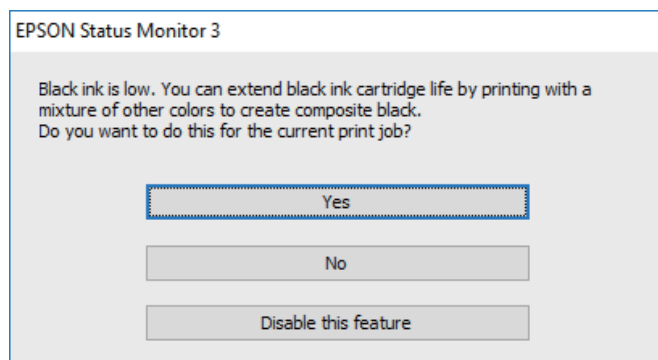

Options	Description
Yes	Select to use a mixture of color inks to create black. This window is displayed the next time you print a similar job.
No	Select to continue using the remaining black ink. This window is displayed the next time you print a similar job.
Disable this feature	Select to continue using the remaining black ink. This window is not displayed until you replace the black ink cartridge and it runs low again.

# Maintaining the Printer

## Checking and Cleaning the Print Head

If the nozzles are clogged, the printouts become faint, there is visible banding, or unexpected colors appear. When print quality has declined, use the nozzle check feature and check if the nozzles are clogged. If the nozzles are clogged, clean the print head.

### **Important:**

- Do not open the scanner unit or turn off the printer during head cleaning. If the head cleaning is incomplete, you may not be able to print.
- Because print head cleaning uses some ink, clean the print head only if quality declines.
- When ink is low, you may not be able to clean the print head. Replace the ink cartridge first.
- If print quality has not improved after repeating nozzle check and head cleaning about four times, wait for at least six hours without printing, and then run the nozzle check again and repeat the head cleaning if necessary. We recommend to turn off the printer. If print quality has still not improved, contact Epson support.
- To prevent the print head from drying out, do not unplug the printer while the power is on.

## Checking and Cleaning the Print Head - Control Panel

1. Load A4-size plain paper in the printer.
2. Select **Maintenance** on the home screen.
3. Select **Print Head Nozzle Check**.
4. Follow the on-screen instructions to print the nozzle check pattern.
5. Examine the printed pattern. If there are broken lines or missing segments as shown in the "NG" pattern, the print head nozzles may be clogged. Go to the next step. If you cannot see any broken lines or missing segments as in the following "OK" pattern, the nozzles are not clogged. Select  to close the nozzle check feature.

**OK**

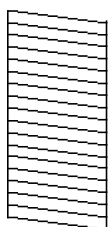

**NG**

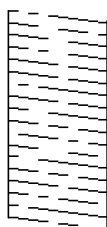

6. Select , and then follow the on-screen instructions to clean the print head.
7. When cleaning is finished, print the nozzle check pattern again. Repeat cleaning and printing the pattern until all lines are printed completely.

**Related Information**

➔ [“Loading Paper in the Paper Cassette” on page 45](#)

## Checking and Cleaning the Print Head - Windows

1. Load A4-size plain paper in the printer.
2. Access the printer driver window.
3. Click **Nozzle Check** on the **Maintenance** tab.
4. Follow the on-screen instructions.

**Related Information**

➔ [“Loading Paper in the Paper Cassette” on page 45](#)

➔ [“Accessing the Printer Driver” on page 64](#)

## Checking and Cleaning the Print Head - Mac OS

1. Load A4-size plain paper in the printer.
2. Select **System Preferences** from the  menu > **Printers & Scanners** (or **Print & Scan**, **Print & Fax**), and then select the printer.
3. Click **Options & Supplies** > **Utility** > **Open Printer Utility**.
4. Click **Nozzle Check**.
5. Follow the on-screen instructions.

**Related Information**

➔ [“Loading Paper in the Paper Cassette” on page 45](#)

---

## Aligning the Print Head

If you notice a misalignment of vertical lines or blurred images, align the print head.

### Aligning the Print Head - Control Panel

1. Load A4-size plain paper in the printer.
2. Select **Maintenance** on the home screen.
3. Select **Print Head Alignment**.

### Maintaining the Printer

4. Select one of the alignment menus, and then follow the on-screen instructions to print an alignment pattern.
  - Ruled Line Alignment: Select this if vertical lines look misaligned.
  - Vertical Alignment: Select this if your printouts look blurry or vertical ruled lines appear misaligned.
  - Horizontal Alignment: Select this if you see horizontal banding at regular intervals.
5. Follow the on-screen instructions to align the print head.
  - Ruled Line Alignment: Find and select the number for the pattern that has the least misaligned vertical line.

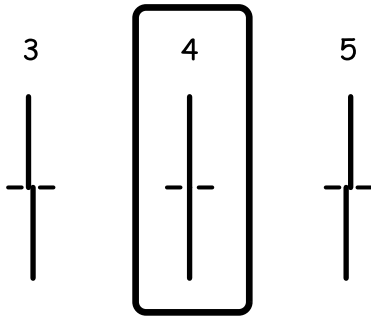

- Vertical Alignment: Find and select the number for the most solid pattern in each group.

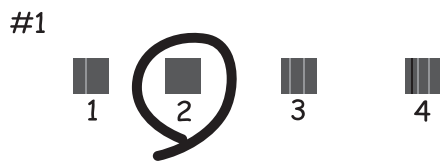

- Horizontal Alignment: Find and select the number for the least separated and overlapping pattern.



#### Related Information

➔ [“Loading Paper in the Paper Cassette” on page 45](#)



---

## Cleaning the Paper Path

When the printouts are smeared or paper does not feed correctly, clean the roller inside.

**Important:**

*Do not use tissue paper to clean the inside of the printer. The print head nozzles may be clogged with lint.*

## Cleaning the Paper Path for Ink Smears

When the printouts are smeared or scuffed, clean the roller inside.

**Important:**

*Do not use tissue paper to clean the inside of the printer. The print head nozzles may be clogged with lint.*

1. Load A4-size plain paper in the printer.
2. Select **Maintenance** on the home screen.
3. Select **Paper Guide Cleaning**.
4. Follow the on-screen instructions to clean the paper path.

**Note:**

*Repeat this procedure until the paper is not smeared with ink.*

**Related Information**

➔ [“Loading Paper in the Paper Cassette” on page 45](#)

## Cleaning the Paper Path for Paper Feeding Problems

When paper is not fed from paper cassette correctly, clean the roller inside.

1. Turn off the printer by pressing the  button.
2. Unplug the power cord, and then disconnect the power cord.

## Maintaining the Printer

3. Pull out paper cassette.

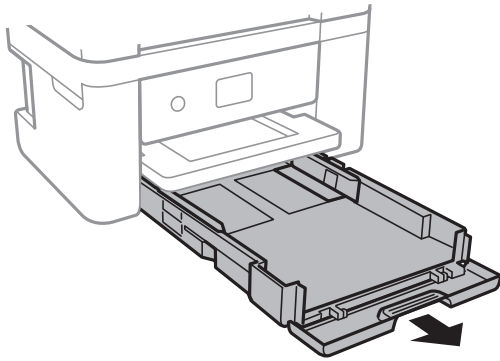

4. Stand the printer with the control panel's  button at the top.

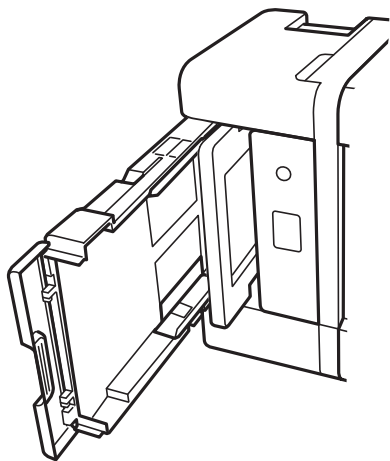

 **Caution:**

*Be careful not to trap your hand or fingers when standing the printer. Otherwise you may be injured.*

5. Dampen a cloth with water, wring it out thoroughly, and then wipe the roller while rotating it with the cloth.

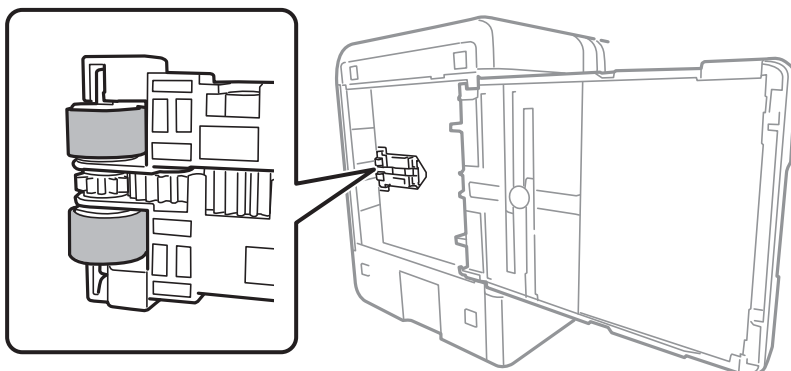

## Maintaining the Printer

- Return the printer to its normal position, and then insert the paper cassette.



**Important:**

*Do not leave the printer standing for a long time.*

- Connect the power cord.

---

## Cleaning the ADF

When the copied or scanned images from the ADF are smeared or the originals do not feed in the ADF correctly, clean the ADF.



**Important:**

*Never use alcohol or thinner to clean the printer. These chemicals can damage the printer.*

- Open the ADF cover.

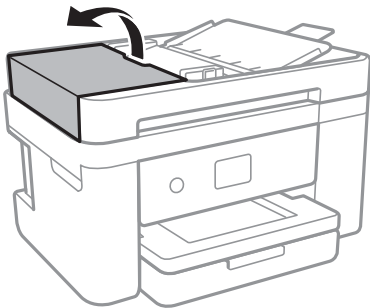

- Use a soft, moist cloth to clean the roller and the interior of the ADF.

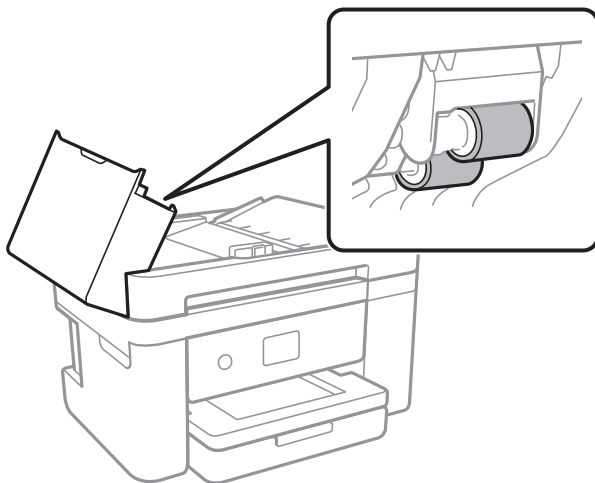

**Important:**

- Using a dry cloth may damage the surface of the roller.
- Use the ADF after the roller has dried.

## Maintaining the Printer

3. Open the document cover.

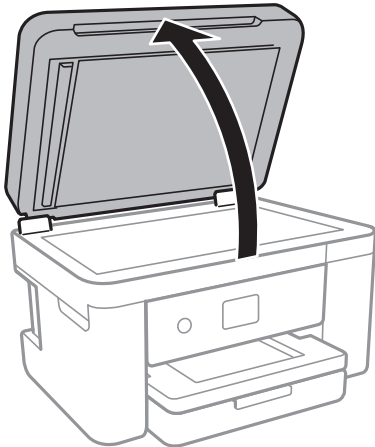

4. Clean the part that is shown in the illustration.

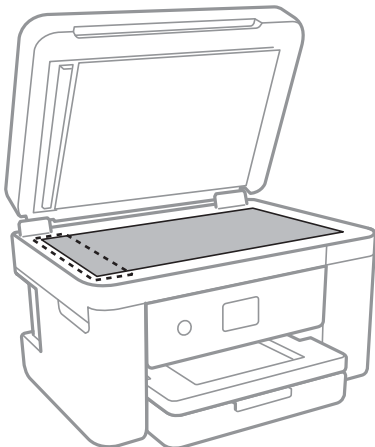

**!** *Important:*

- If the glass surface is stained with grease or some other hard-to-remove material, use a small amount of glass cleaner and a soft cloth to remove it. Wipe off all remaining liquid.*
- Do not press the glass surface too hard.*
- Be careful not to scratch or damage the surface of the glass. A damaged glass surface can decrease the scan quality.*

---

## Cleaning the Scanner Glass

When the copies or scanned images are smeared, clean the scanner glass.

**!** *Caution:*

*Be careful not to trap your hand or fingers when opening or closing the document cover. Otherwise you may be injured.*

## Maintaining the Printer

**!** **Important:**

*Never use alcohol or thinner to clean the printer. These chemicals can damage the printer.*

1. Open the document cover.

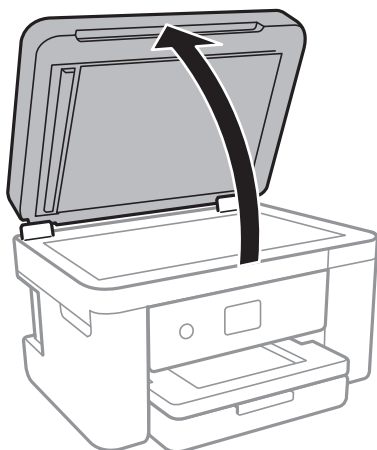

2. Use a soft, dry, clean cloth to clean the surface of the scanner glass.

**!** **Important:**

- If the glass surface is stained with grease or some other hard-to-remove material, use a small amount of glass cleaner and a soft cloth to remove it. Wipe off all remaining liquid.*
- Do not press the glass surface too hard.*
- Be careful not to scratch or damage the surface of the glass. A damaged glass surface can decrease the scan quality.*

---

## Cleaning the Translucent Film

When the printout is not improved after aligning the print head or cleaning the paper path, the translucent film inside the printer may be smeared.

Items required:

- Cotton swabs (several)
- Water with a few drops of detergent (2 to 3 drops of detergent in 1/4 cup of tap water)
- Light for checking smears

**!** **Important:**

*Do not use cleaning liquid other than water with a few drops of detergent.*

1. Turn off the printer by pressing the  button.

## Maintaining the Printer

2. Open the scanner unit.

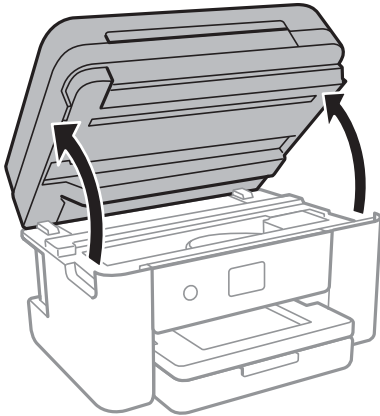

3. Check if the translucent film is smeared. Smears are easier to see if you use a light.  
If there are smears (such as finger marks or grease) on the translucent film (A), go to the next step.

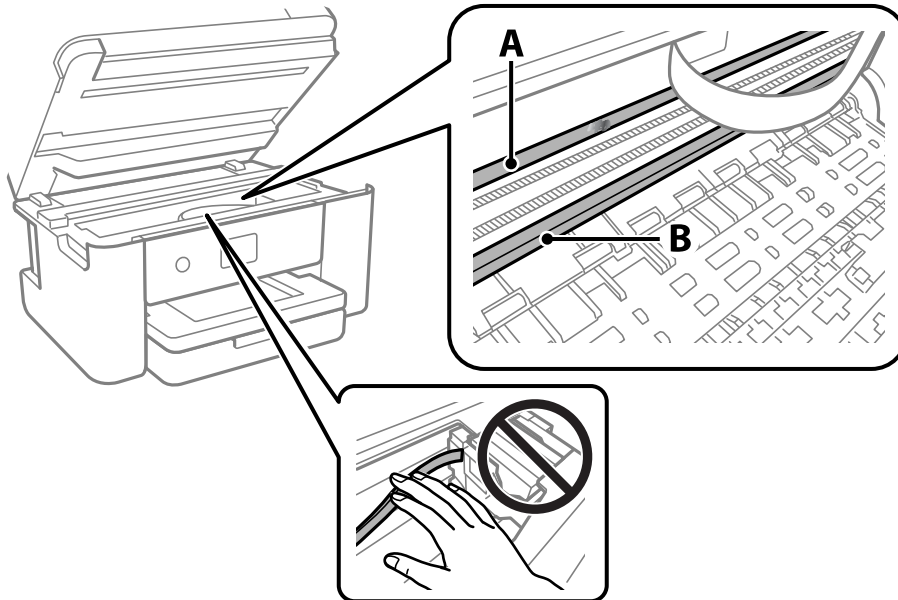

A: Translucent film

B: Rail



**Important:**

*Be careful not to touch the rail (B). Otherwise, you may not be able to print. Do not wipe off the grease on the rail, because this is necessary for operations.*

## Maintaining the Printer

4. Moisten a cotton swab with the water with a few drops of detergent so that it is not dripping water, and then wipe the smeared part.

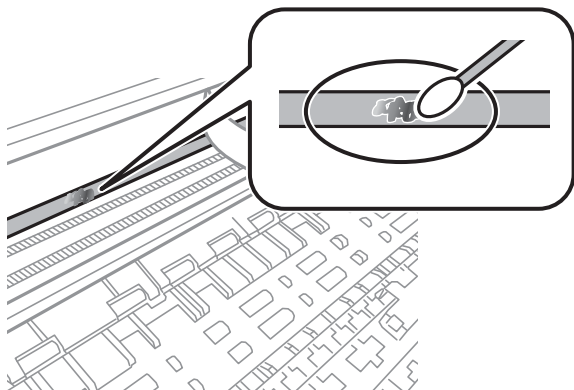

**!** **Important:**

*Wipe off the smear gently. If you press the cotton swab too hard to the film, the springs of the film may be dislocated and the printer may be damaged.*

5. Use a new dry cotton swab to wipe the film.

**!** **Important:**

*Do not leave any fibers on the film.*

**Note:**

*To prevent the smear from spreading, frequently replace the cotton swab with a new one.*

6. Repeat steps 4 and 5 until the film is not smeared.
7. Visually check that the film is not smeared.

# Network Service and Software Information

This section introduces the network services and software products available for your printer from the Epson website or the supplied software disc.

---

## Application for Configuring Printer Operations (Web Config)

Web Config is an application that runs in a web browser, such as Internet Explorer and Safari, on a computer or smart device. You can confirm the printer status or change the network service and printer settings. To use the Web Config, connect the printer and the computer or device to the same network.

The following browsers are supported.

OS	Browser
Windows XP SP3 or later	Internet Explorer 8 or later, Firefox*, Chrome*
Mac OS X v10.6.8 or later	Safari*, Firefox*, Chrome*
iOS*	Safari*
Android 2.3 or later	Default browser
Chrome OS*	Default browser

\* Use the latest version.

## Running Web Config on a Web Browser

1. Check the printer's IP address.

Select the network icon on the printer's home screen, and then select the active connection method to confirm the printer's IP address.

**Note:**

*You can also check the IP address by printing the network connection report.*

2. Launch a Web browser from a computer or smart device, and then enter the printer's IP address.

Format:

IPv4: `http://the printer's IP address/`

IPv6: `http://[the printer's IP address]/`

Examples:

IPv4: `http://192.168.100.201/`

IPv6: `http://[2001:db8::1000:1]/`



## Network Service and Software Information

**Note:**

Using the smart device, you can also run Web Config from the maintenance screen of Epson iPrint.

**Related Information**

- ➔ [“Printing a Network Connection Report” on page 31](#)
- ➔ [“Using Epson iPrint” on page 90](#)

## Running Web Config on Windows

When connecting a computer to the printer using WSD, follow the steps below to run Web Config.

1. Access the devices and printers screen in Windows.
  - Windows 10/Windows Server 2016  
Right-click the start button or press and hold it, and then select **Control Panel > View devices and printers** in **Hardware and Sound**.
  - Windows 8.1/Windows 8/Windows Server 2012 R2/Windows Server 2012  
Select **Desktop > Settings > Control Panel > View devices and printers** in **Hardware and Sound** (or **Hardware**).
  - Windows 7/Windows Server 2008 R2  
Click the start button, and select **Control Panel > View devices and printers** in **Hardware and Sound**.
  - Windows Vista/Windows Server 2008  
Click the start button, and select **Control Panel > Printers** in **Hardware and Sound**.
2. Right-click on your printer and select **Properties**.
3. Select the **Web Service** tab and click the URL.

## Running Web Config on Mac OS

1. Select **System Preferences** from the  menu > **Printers & Scanners** (or **Print & Scan, Print & Fax**), and then select the printer.
2. Click **Options & Supplies > Show Printer Webpage**.

---

## Application for Scanning Documents and Images (Epson Scan 2)

Epson Scan 2 is an application for controlling scanning. You can adjust the size, resolution, brightness, contrast, and quality of the scanned image. You can also start Epson Scan 2 from a TWAIN-compliant scanning application. See the application's help for details.

## Network Service and Software Information

### Starting on Windows

**Note:**

For Windows Server operating systems, make sure the **Desktop Experience** feature is installed.

- ❑ Windows 10/Windows Server 2016

Click the start button, and then select **EPSON > Epson Scan 2**.

- ❑ Windows 8.1/Windows 8/Windows Server 2012 R2/Windows Server 2012

Enter the application name in the search charm, and then select the displayed icon.

- ❑ Windows 7/Windows Vista/Windows XP/Windows Server 2008 R2/Windows Server 2008/Windows Server 2003 R2/Windows Server 2003

Click the start button, and then select **All Programs** or **Programs > EPSON > Epson Scan 2 > Epson Scan 2**.

### Starting on Mac OS

**Note:**

Epson Scan 2 does not support the Mac OS fast user switching feature. Turn off fast user switching.

Select **Go > Applications > Epson Software > Epson Scan 2**.

### Related Information

- ➔ [“Scanning Using Epson Scan 2” on page 107](#)
- ➔ [“Installing the Latest Applications” on page 175](#)

## Adding the Network Scanner

Before using Epson Scan 2, you need to add the network scanner.

1. Start the software, and then click **Add** on the **Scanner Settings** screen.

**Note:**

- ❑ If **Add** is grayed out, click **Enable Editing**.

- ❑ If the main screen of Epson Scan 2 is displayed, it has already been connected to the scanner. If you want to connect to another network, select **Scanner > Settings** to open the **Scanner Settings** screen.

2. Add the network scanner. Enter the following items, and then click **Add**.

- ❑ **Model:** Select the scanner you want to connect to.

- ❑ **Name:** Enter the scanner name within 32 characters.

- ❑ **Search for Network:** When the computer and the scanner are on the same network, the IP address is displayed. If it is not displayed, click the  button. If the IP address is still not displayed, click **Enter address**, and then enter the IP address directly.

3. Select the scanner on the **Scanner Settings** screen, and then click **OK**.

---

## Application for Configuring Scanning Operations from the Control Panel (Epson Event Manager)

Epson Event Manager is an application that allows you to manage scanning from the control panel and save images to a computer. You can add your own settings as presets, such as the document type, the save folder location, and the image format. See the application's help for details.

**Note:**

*Windows Server operating systems are not supported.*

**Starting on Windows** Windows 10

Click the start button, and then select **Epson Software > Event Manager**.

 Windows 8.1/Windows 8

Enter the application name in the search charm, and then select the displayed icon.

 Windows 7/Windows Vista/Windows XP

Click the start button, and then select **All Programs** or **Programs > Epson Software > Event Manager**.

**Starting on Mac OS**

**Go > Applications > Epson Software > Event Manager**.

**Related Information**

➔ [“Installing the Latest Applications” on page 175](#)

---

## Application for Configuring Fax Operations and Sending Faxes (FAX Utility)

FAX Utility is an application that allows you to configure various settings for sending faxes from a computer. You can create or edit the contacts list to be used when sending a fax, configure to save received faxes in PDF format on the computer, and so on. See the application's help for details.

**Note:**

*Windows Server operating systems are not supported.*

*Make sure you have installed the printer driver before installing FAX Utility.*

**Starting on Windows** Windows 10

Click the start button, and select **Epson Software > FAX Utility**.

 Windows 8.1/Windows 8

Enter the application name in the search charm, and then select the displayed icon.

 Windows 7/Windows Vista/Windows XP

Click the start button, and select **All Programs** (or **Programs**) > **Epson Software > FAX Utility**.

## Starting on Mac OS

Select **System Preferences** from the  menu > **Printers & Scanners** (or **Print & Scan, Print & Fax**), and then select the printer (FAX). Click **Options & Supplies** > **Utility** > **Open Printer Utility**.

### Related Information

- ➔ [“Receiving Faxes on a Computer” on page 137](#)
- ➔ [“Installing the Latest Applications” on page 175](#)

---

## Application for Sending Faxes (PC-FAX Driver)

PC-FAX driver is an application that allows you to send a document created on a separate application as a fax directly from the computer. PC-FAX driver is installed when you install FAX Utility. See the application's help for details.

### Note:

- Windows Server operating systems are not supported.*
- The operation differs depending on the application you used to create the document. See the application's help for details.*

### Accessing from Windows

In the application, select **Print** or **Print Setup** from the **File** menu. Select your printer (FAX), and then click **Preferences** or **Properties**.

### Accessing from Mac OS

In the application, select **Print** from the **File** menu. Select your printer (FAX) as the **Printer** setting, and then select **Fax Settings** or **Recipient Settings** from the pop-up menu.

### Related Information

- ➔ [“Sending a Fax from a Computer” on page 133](#)
- ➔ [“Application for Configuring Fax Operations and Sending Faxes \(FAX Utility\)” on page 171](#)

---

## Application for Laying Out Photos (Epson Easy Photo Print)

Epson Easy Photo Print is an application that allows you to easily print photos with various layouts. You can preview the photo image and adjust the images or position. You can also print photos with a frame. See the application's help for details.

By printing on genuine Epson photo paper, the ink quality is maximized and the printouts are vivid and clear.

To perform borderless printing using a commercially available application, make the following settings.

- Create image data to fit the paper size. If a margin setting is available in the application you are using, set the margin to 0 mm.
- Enable the borderless printing setting in the printer driver.

## Network Service and Software Information

**Note:**

- Windows Server operating systems are not supported.*
- To use this application, the printer driver needs to be installed.*

**Starting on Windows**

- Windows 10

Click the start button, and then select **Epson Software > Epson Easy Photo Print**.

- Windows 8.1/Windows 8

Enter the application name in the search charm, and then select the displayed icon.

- Windows 7/Windows Vista/Windows XP

Click the start button, and then select **All Programs** or **Programs > Epson Software > Epson Easy Photo Print**.

**Starting on Mac OS**

**Go > Applications > Epson Software > Epson Easy Photo Print**.

**Related Information**

➔ [“Installing the Latest Applications” on page 175](#)

---

## Application for Printing Web Pages (E-Web Print)

E-Web Print is an application that allows you to easily print web pages with various layouts. See the application's help for details. You can access the help from the **E-Web Print** menu on the **E-Web Print** tool bar.

**Note:**

- Windows Server operating systems are not supported.*
- Check for supported browsers and the latest version from the download site.*

**Starting**

When you install E-Web Print, it is displayed in your browser. Click **Print** or **Clip**.

**Related Information**

➔ [“Installing the Latest Applications” on page 175](#)

---

## Application for Scanning and Transferring Images (Easy Photo Scan)

Easy Photo Scan is an application that allows you to scan photos and easily send the scanned image to a computer or cloud service. You can also easily adjust the scanned image. See the application's help for details.

**Note:**

*To use this application, the scanner driver Epson Scan 2 needs to be installed.*

## Network Service and Software Information

### Starting on Windows

Windows 10

Click the start button, and then select **Epson Software > Easy Photo Scan**.

Windows 8.1/Windows 8

Enter the application name in the search charm, and then select the displayed icon.

Windows 7/Windows Vista/Windows XP

Click the start button, and then select **All Programs** or **Programs > Epson Software > Easy Photo Scan**.

### Starting on Mac OS

Select **Go > Applications > Epson Software > Easy Photo Scan**.

---

## Software Update Tools (EPSON Software Updater)

EPSON Software Updater is an application that checks for new or updated software on the internet and installs it. You can also update the printer's firmware and manual.

**Note:**

*Windows Server operating systems are not supported.*

### Installing Method

Download EPSON Software Updater from the Epson website.

If you are using a Windows computer and cannot to download it from the website, you can install it from the supplied software disc.

<http://www.epson.com>

### Starting on Windows

Windows 10

Click the start button, and then select **Epson Software > EPSON Software Updater**.

Windows 8.1/Windows 8

Enter the application name in the search charm, and then select the displayed icon.

Windows 7/Windows Vista/Windows XP

Click the start button, and then select **All Programs** or **Programs > Epson Software > EPSON Software Updater**.

**Note:**

*You can also start EPSON Software Updater by clicking the printer icon on the task bar on the desktop, and then selecting **Software Update**.*

### Starting on Mac OS

Select **Go > Applications > Epson Software > EPSON Software Updater**.

---

## Application for Configuring Multiple Devices (EpsonNet Config)

EpsonNet Config is an application that allows you to set the network interface addresses and protocols. See the operations guide for EpsonNet Config or the application's help for more details.

### Starting on Windows

- Windows 10/Windows Server 2016

Click the start button, and then select **EpsonNet > EpsonNet Config**.

- Windows 8.1/Windows 8/Windows Server 2012 R2/Windows Server 2012

Enter the application name in the search charm, and then select the displayed icon.

- Windows 7/Windows Vista/Windows XP/Windows Server 2008 R2/Windows Server 2008/Windows Server 2003 R2/Windows Server 2003

Click the start button, and select **All Programs** or **Programs > EpsonNet > EpsonNet Config SE > EpsonNet Config**.

### Starting on Mac OS

**Go > Applications > Epson Software > EpsonNet > EpsonNet Config SE > EpsonNet Config**.

---

## Installing the Latest Applications

### Note:

*When reinstalling an application, you need to uninstall it first.*

1. Make sure the printer and the computer are available for communication, and the printer is connected to the Internet.

## Network Service and Software Information

2. Start EPSON Software Updater.

The screenshot is an example on Windows.

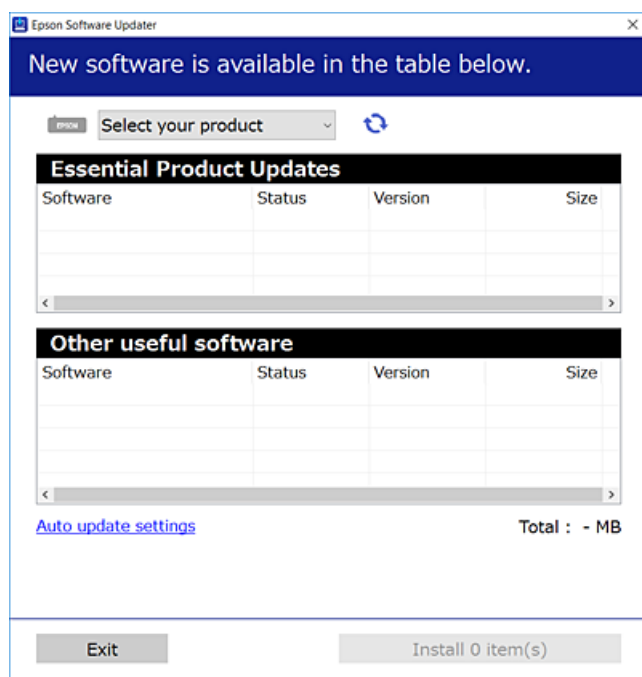

3. For Windows, select your printer, and then click  to check for the latest available applications.
4. Select the items you want to install or update, and then click the install button.



**Important:**

*Do not turn off or unplug the printer until the update is complete; otherwise, the printer may malfunction.*

**Note:**

- You can download the latest applications from the Epson website.  
<http://www.epson.com>
- If you use Windows Server operating systems, you cannot use EPSON Software Updater. Download the latest applications from the Epson website.

### Related Information

- ➔ [“Software Update Tools \(EPSON Software Updater\)” on page 174](#)
- ➔ [“Uninstalling Applications” on page 177](#)

---

## Updating the Printer's Firmware using the Control Panel

If the printer is connected to the Internet, you can update the printer's firmware using the control panel. You can also set the printer to regularly check for firmware updates and notify you if any are available.

1. Select **Settings** on the home screen.



## Network Service and Software Information

2. Select **Firmware Update > Update**.

**Note:**

Enable **Notification** to set the printer to regularly check for available firmware updates.

3. Check the message displayed on the screen and tap **Start Checking** to start searching for available updates.
4. If a message is displayed on the LCD screen informing you that a firmware update is available, follow the on-screen instructions to start the update.



**Important:**

- ❑ Do not turn off or unplug the printer until the update is complete; otherwise, the printer may malfunction.
- ❑ If the firmware update is not completed or is unsuccessful, the printer does not start up normally and "Recovery Mode" is displayed on the LCD screen the next time the printer is turned on. In this situation, you need to update the firmware again using a computer. Connect the printer to the computer with a USB cable. While "Recovery Mode" is displayed on the printer, you cannot update the firmware over a network connection. On the computer, access your local Epson website, and then download the latest printer firmware. See the instructions on the website for the next steps.

---

## Uninstalling Applications

Log in to your computer as an administrator. Enter the administrator password if the computer prompts you.

### Uninstalling Applications - Windows

1. Press the  button to turn off the printer.
2. Quit all running applications.
3. Open **Control Panel**:
  - ❑ Windows 10/Windows Server 2016  
Right-click the start button or press and hold it, and then select **Control Panel**.
  - ❑ Windows 8.1/Windows 8/Windows Server 2012 R2/Windows Server 2012  
Select **Desktop > Settings > Control Panel**.
  - ❑ Windows 7/Windows Vista/Windows XP/Windows Server 2008 R2/Windows Server 2008/Windows Server 2003 R2/Windows Server 2003  
Click the start button and select **Control Panel**.
4. Open **Uninstall a program** (or **Add or Remove Programs**):
  - ❑ Windows 10/Windows 8.1/Windows 8/Windows 7/Windows Vista/Windows Server 2016/Windows Server 2012 R2/Windows Server 2012/Windows Server 2008 R2/Windows Server 2008  
Select **Uninstall a program** in **Programs**.
  - ❑ Windows XP/Windows Server 2003 R2/Windows Server 2003  
Click **Add or Remove Programs**.

## Network Service and Software Information

5. Select the application you want to uninstall.

You cannot uninstall the printer driver if there is any print jobs. Delete or wait to be printed the jobs before uninstalling.

6. Uninstall the applications:

Windows 10/Windows 8.1/Windows 8/Windows 7/Windows Vista/Windows Server 2016/Windows Server 2012 R2/Windows Server 2012/Windows Server 2008 R2/Windows Server 2008

Click **Uninstall/Change** or **Uninstall**.

Windows XP/Windows Server 2003 R2/Windows Server 2003

Click **Change/Remove** or **Remove**.

**Note:**

If the **User Account Control** window is displayed, click **Continue**.

7. Follow the on-screen instructions.

## Uninstalling Applications - Mac OS

1. Download the Uninstaller using EPSON Software Updater.

Once you have downloaded the Uninstaller, you do not need to download it again each time you uninstall the application.

2. Press the  button to turn off the printer.

3. To uninstall the printer driver or PC-FAX driver, select **System Preferences** from the  menu > **Printers & Scanners** (or **Print & Scan, Print & Fax**), and then remove the printer from the enabled printers list.

4. Quit all running applications.

5. Select **Go > Applications > Epson Software > Uninstaller**.

6. Select the application you want to uninstall, and then click **Uninstall**.



**Important:**

The Uninstaller removes all drivers for Epson inkjet printers on the computer. If you use multiple Epson inkjet printers and you only want to delete some drivers, delete all of them first, and then install the necessary printer driver again.

**Note:**

If you cannot find the application you want to uninstall in the application list, you cannot uninstall using the Uninstaller. In this situation, select **Go > Applications > Epson Software**, select the application you want to uninstall, and then drag it to the trash icon.

### Related Information

➔ [“Software Update Tools \(EPSON Software Updater\)” on page 174](#)

---

## Printing Using a Network Service

By using Epson Connect service available on the Internet, you can print from your smartphone, tablet PC, or laptop, anytime and practically anywhere. To use this service, you need to register the user and the printer in Epson Connect.

The features available on the Internet are as follows.

Email Print

When you send an email with attachments such as documents or images to an email address assigned to the printer, you can print that email and the attachments from remote locations such as your home or office printer.

Epson iPrint

This Application is for iOS and Android, and allows you to print or scan from a smart phone or tablet. You can print documents, images, and websites by sending them directly to a printer on the same wireless LAN.

Scan to Cloud

This application allows you to send the scanned data you want to print to another printer. You can also upload the scanned data to available Cloud services.

Remote Print Driver

This is a shared driver supported by Remote Print Driver. When printing using a printer in a remote location, you can print by changing the printer on the usual applications window.

See the Epson Connect web portal for details.

<https://www.epsonconnect.com/>

<http://www.epsonconnect.eu> (Europe only)

# Solving Problems

## Checking the Printer Status

### Checking Messages on the LCD Screen

If an error message is displayed on the LCD screen, follow the on-screen instructions or the solutions below to solve the problem.

Error Messages	Solutions
Printer Error Turn on the printer again. See your documentation for more details.	Remove any paper or protective material in the printer. If the error message is still displayed, contact Epson support.
Paper out in XX.	Load paper, and then insert the paper cassette all the way.
You need to replace Ink Cartridge.	To ensure you receive premium print quality and to help protect your print head, a variable ink safety reserve remains in the cartridge when your printer indicates it is time to replace the cartridge. Replace the cartridge when you are prompted to do so.
The printer's borderless printing ink pad is nearing the end of its service life. It is not a user-replaceable part. Please contact Epson support.	Contact Epson or an authorised Epson service provider to replace the borderless printing ink pad*. It is not a user-serviceable part. The message will be displayed until the ink pad is replaced.  Tap <b>OK</b> to resume printing.
The printer's borderless printing ink pad has reached the end of its service life. It is not a user-replaceable part. Please contact Epson support.	Contact Epson or an authorised Epson service provider to replace the borderless printing ink pad*. It is not a user-serviceable part.  However, non-printing features such as scanning are available.
Paper Setup Auto Display is set to Off. Some features may not be available. For details, see your documentation.	If <b>Paper Setup Auto Display</b> is disabled, you cannot use AirPrint.
No dial tone is detected.	This problem might be resolved by selecting <b>Settings &gt; General Settings &gt; Fax Settings &gt; Basic Settings &gt; Line Type</b> and then selecting <b>PBX</b> . If your phone system requires an external access code to get an outside line, set the access code after selecting <b>PBX</b> . Use # (hash) instead of the actual access code when entering an outside fax number. This makes connection more secure.  If the error message is still displayed, set the <b>Dial Tone Detection</b> settings to disabled. However, disabling this feature may drop the first digit of a fax number and send the fax to the wrong number.
The combination of the IP address and the subnet mask is invalid. See your documentation for more details.	Enter the correct IP address or default gateway. Contact the person who setup the network for assistance.
To use cloud services, update the root certificate from the Epson Web Config utility.	Run Web Config, and then update the root certificate.

## Solving Problems

Error Messages	Solutions
Check that the printer driver is installed on the computer and that the port settings for the printer are correct.	Click <b>Print Queue</b> on the printer driver's <b>Maintenance</b> tab. Make sure the printer port is selected correctly in <b>Property &gt; Port</b> from the <b>Printer</b> menu as follows.
Check that the printer driver is installed on the computer and that the USB port settings for the printer are correct.	Select " <b>USBXXX</b> " for a USB connection, or " <b>EpsonNet Print Port</b> " for a network connection.
Recovery Mode	<p>The printer has started in recovery mode because the firmware update failed. Follow the steps below to try to update the firmware again.</p> <ol style="list-style-type: none"> <li>1. Connect the computer and the printer with a USB cable. (During recovery mode, you cannot update the firmware over a network connection.)</li> <li>2. Visit your local Epson website for further instructions.</li> </ol>

\* In some print cycles a very small amount of surplus ink may be collected in the ink pad. To prevent ink leakage from the pad, the product is designed to stop printing when the pad has reached its limit. Whether and how often this is required will vary according to the number of pages you print using the borderless print option. The need for replacement of the pad does not mean that your printer has ceased to operate in accordance with its specifications. The printer will advise you when the pad requires replacing and this can only be performed by an authorised Epson Service provider. The Epson warranty does not cover the cost of this replacement.

### Related Information

- ➔ [“Contacting Epson Support” on page 223](#)
- ➔ [“Installing the Latest Applications” on page 175](#)
- ➔ [“Updating the Printer's Firmware using the Control Panel” on page 176](#)

## Checking the Printer Status - Windows

1. Access the printer driver window.
2. Click **EPSON Status Monitor 3** on the **Maintenance** tab, and then click **Details**.

You can check the printer status, ink levels, and error status.

**Note:**

*If EPSON Status Monitor 3 is disabled, click **Extended Settings** on the **Maintenance** tab, and then select **Enable EPSON Status Monitor 3**.*

### Related Information

- ➔ [“Accessing the Printer Driver” on page 64](#)

## Checking the Printer Status - Mac OS

1. Select **System Preferences** from the  menu > **Printers & Scanners** (or **Print & Scan**, **Print & Fax**), and then select the printer.
2. Click **Options & Supplies** > **Utility** > **Open Printer Utility**.

## Solving Problems

### 3. Click EPSON Status Monitor.

You can check the printer status, ink levels, and error status.

---

## Checking the Software Status

You may be able to clear the problem by updating the software to the latest version. To check the software status, use the software update tool.

### Related Information

- ➔ [“Software Update Tools \(EPSON Software Updater\)” on page 174](#)
- ➔ [“Installing the Latest Applications” on page 175](#)

---

## Removing Jammed Paper

Follow the on-screen instructions on the printer's control panel to locate and remove the jammed paper including any torn pieces. The LCD screen displays an animation that shows you how to remove jammed paper.



### **Caution:**

*Never touch the buttons on the control panel while your hand is inside the printer. If the printer starts operating, it could cause an injury. Be careful not to touch the protruding parts to avoid injury.*



### **Important:**

*Remove the jammed paper carefully. Removing the paper vigorously may cause damage to the printer.*

---

## Paper Does Not Feed Correctly

Check the following points, and then take the appropriate actions to solve the problem.

- Place the printer on a flat surface and operate in the recommended environmental conditions.
- Use paper supported by this printer.
- Follow the paper handling precautions.
- Do not load more than the maximum number of sheets specified for the paper.
- Make sure the paper size and paper type settings match the actual paper size and paper type loaded in the printer.
- Clean the roller inside the printer.

### Related Information

- ➔ [“Environmental Specifications” on page 217](#)
- ➔ [“Paper Handling Precautions” on page 44](#)
- ➔ [“Available Paper and Capacities” on page 43](#)

## Solving Problems

➔ [“List of Paper Type” on page 48](#)

### Paper Jams

Load paper in the correct direction, and slide the edge guides against the edges of the paper.

#### Related Information

- ➔ [“Removing Jammed Paper” on page 182](#)
- ➔ [“Loading Paper in the Paper Cassette” on page 45](#)

### Paper Feeds at a Slant

Load paper in the correct direction, and slide the edge guides against the edges of the paper.

#### Related Information

- ➔ [“Loading Paper in the Paper Cassette” on page 45](#)

### Several Sheets of Paper are Fed at a Time

When several sheets of paper are fed at a time during manual 2-sided printing, remove any paper which is loaded in the printer before you reload the paper.

### Original Does Not Feed in the ADF

- Use originals supported by the ADF.
- Load originals in the correct direction, and slide the ADF edge guides against the edges of the originals.
- Clean the inside of the ADF.
- Do not load originals above the line indicated by the triangle symbol on the ADF.

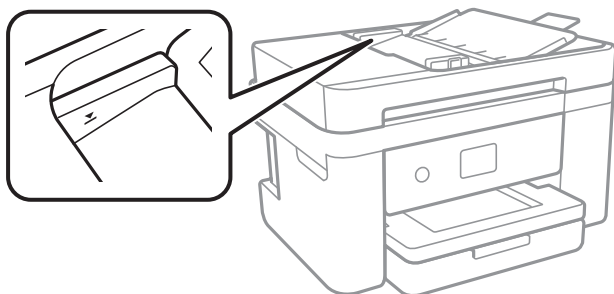

- Check that the ADF icon is on at the bottom of the screen. If it is off, place the originals again.

#### Related Information

- ➔ [“Available Originals for the ADF” on page 49](#)
- ➔ [“Placing Originals on the ADF” on page 50](#)

➔ [“Cleaning the ADF” on page 163](#)



---

## Power and Control Panel Problems

### Power Does Not Turn On

- Make sure the power cord is securely plugged in.
- Hold down the  button for a little longer.

### Power Does Not Turn Off

Hold down the  button for a little longer. If you still cannot turn off the printer, unplug the power cord. To prevent the print head from drying out, turn the printer back on and turn it off by pressing the  button.

### Power Turns Off Automatically

- Select **Settings > General Settings > Basic Settings > Power Off Settings**, and then disable the **Power Off If Inactive** and **Power Off If Disconnected** settings.
- Select **Settings > General Settings > Basic Settings**, and then disable the **Power Off Timer** setting.

**Note:**

*Your product may have the **Power Off Settings** or **Power Off Timer** feature depending on the location of purchase.*

### LCD Screen Gets Dark

The printer is in sleep mode. Tap anywhere on the LCD screen to return it to its former state.

---

## Cannot Print from a Computer

### Checking the Connection (USB)

- Connect the USB cable securely to the printer and the computer.
- If you are using a USB hub, try to connect the printer directly to the computer.
- If the USB cable cannot be recognized, change the port, or change the USB cable.



## Solving Problems

- ❑ If the printer cannot print using a USB connection, try the following.

Disconnect the USB cable from the computer. Right-click on the printer icon displayed on the computer, and then select **Remove Device**. Next, connect the USB cable to the computer and try a test print.

Re-set the USB connection by following the steps in this manual for changing the connection method to a computer. See the related information link below for details.

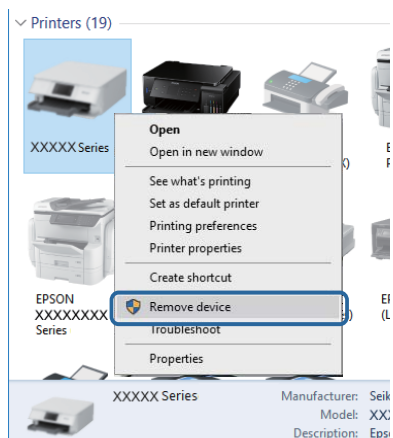

### Related Information

- ➔ [“Changing the Connection Method to a Computer” on page 39](#)

## Checking the Connection (Network)

- ❑ When you have changed your access point or provider, try making network settings for the printer again. Connect the computer or smart device to the same SSID as the printer.
- ❑ Turn off the devices you want to connect to the network. Wait for about 10 seconds, and then turn on the devices in the following order; access point, computer or smart device, and then printer. Move the printer and computer or smart device closer to the access point to help with radio wave communication, and then try to make network settings again.
- ❑ Print the network connection report. See the related information link below for details. If the report shows that the network connection failed, check the network connection report and then follow the printed solutions.
- ❑ If the IP address assigned to the printer is 169.254.XXX.XXX, and the subnet mask is 255.255.0.0, the IP address may not be assigned correctly. Restart the access point or reset the network settings for the printer. If this does not solve the problem, see the documentation for the access point.
- ❑ Try accessing any website from your computer to make sure that your computer's network settings are correct. If you cannot access any website, there is a problem on the computer. Check the network connection of the computer.

### Related Information

- ➔ [“Connecting to a Computer” on page 23](#)
- ➔ [“Printing a Network Connection Report” on page 31](#)

## Solving Problems

### Checking the Software and Data

- Make sure that a genuine Epson printer driver is installed. If a genuine Epson printer driver is not installed, the available functions are limited. We recommend using a genuine Epson printer driver. See the related information link below for details.
- If you are printing a large data size image, the computer may run out of memory. Print the image at a lower resolution or a smaller size.

#### Related Information

- ➔ [“Checking for Genuine Epson Printer Drivers” on page 186](#)
- ➔ [“Installing the Latest Applications” on page 175](#)

### Checking for Genuine Epson Printer Drivers

You can check if a genuine Epson printer driver is installed on your computer by using one of the following methods.

#### Windows

Select **Control Panel > View devices and printers (Printers, Printers and Faxes)**, and then do the following to open the print server properties window.

- Windows 10/Windows 8.1/Windows 8/Windows 7/Windows Server 2016/Windows Server 2012 R2/Windows Server 2012/Windows Server 2008 R2  
Click the printer icon, and then click **Print server properties** at the top of the window.
- Windows Vista/Windows Server 2008  
Right-click on the **Printers** folder, and then click **Run as administrator > Server Properties**.
- Windows XP/Windows Server 2003 R2/Windows Server 2003  
From the **File** menu, select **Server Properties**.

## Solving Problems

Click the **Driver** tab. If your printer name is displayed in the list, a genuine Epson printer driver is installed on your computer.

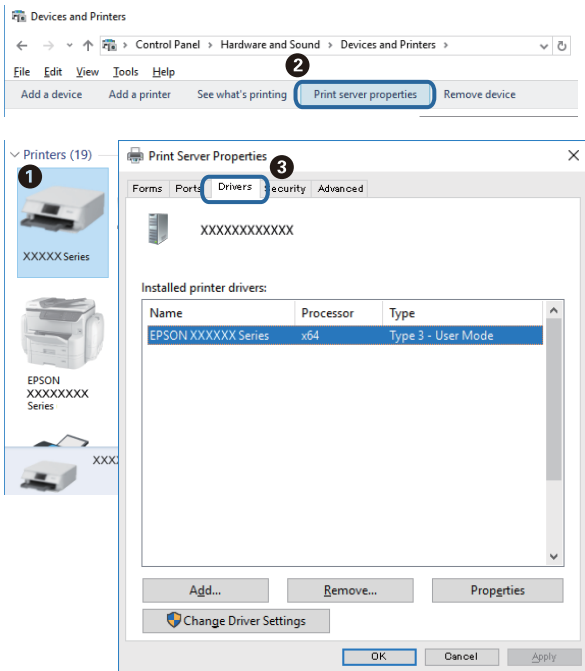

## Mac OS

Select **System Preferences** from the  menu > **Printers & Scanners** (or **Print & Scan, Print & Fax**), and then select the printer. Click **Options & Supplies**, and if the **Options** tab and **Utility** tab are displayed on the window, a genuine Epson printer driver is installed on your computer.



## Related Information

➔ [“Installing the Latest Applications” on page 175](#)

## Solving Problems

### Checking the Printer Status from the Computer (Windows)

Click **Print Queue** on the printer driver's **Maintenance** tab, and then check the following.

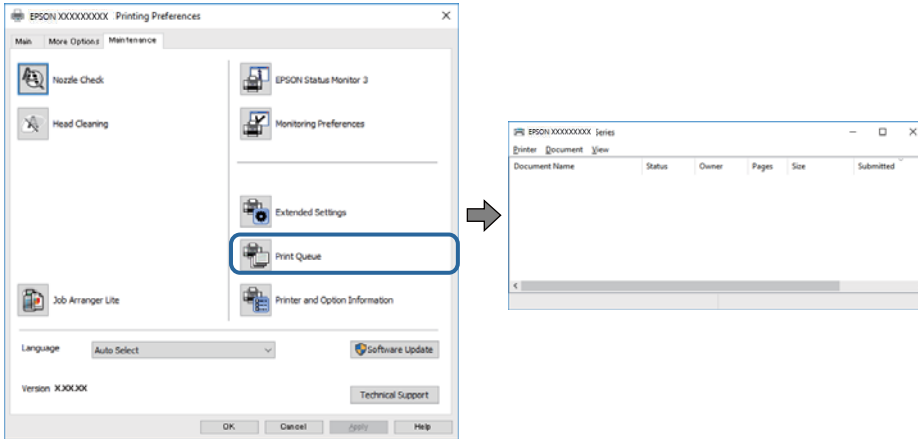

- Check if there are any paused print jobs.  
If unnecessary data remains, select **Cancel all documents** from the **Printer** menu.
- Make sure the printer is not offline or pending.  
If the printer is offline or pending, clear the offline or pending setting from the **Printer** menu.

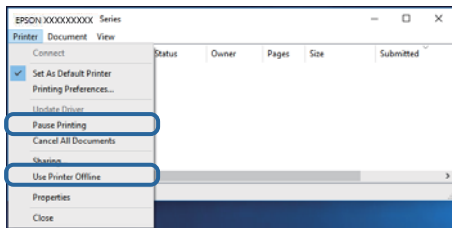

- Make sure the printer is selected as the default printer from the **Printer** menu (there should be a check mark on the menu item).  
If the printer is not selected as the default printer, set it as the default printer. If there are multiple icons in **Control Panel > View devices and printers (Printers, Printers and Faxes)**, see the following to select the icon.  
Example)  
USB connection: EPSON XXXX Series  
Network connection: EPSON XXXX Series (network)  
If you install the printer driver multiple times, copies of printer driver may be created. If copies such as "EPSON XXXX Series (copy 1)" are created, right-click the copied driver icon, and then click **Remove Device**.
- Make sure the printer port is selected correctly in **Property > Port** from the **Printer** menu as follows.  
Select "USBXXX" for a USB connection, or "EpsonNet Print Port" for a network connection.

### Checking the Printer Status from the Computer (Mac OS)

Make sure the printer status is not **Pause**.

Select **System Preferences** from the  menu > **Printers & Scanners** (or **Print & Scan, Print & Fax**), and then double-click the printer. If the printer is paused, click **Resume** (or **Resume Printer**).

---

## When You Cannot Make Network Settings

- ❑ Turn off the devices you want to connect to the network. Wait for about 10 seconds, and then turn on the devices in the following order; access point, computer or smart device, and then printer. Move the printer and computer or smart device closer to the access point to help with radio wave communication, and then try to make network settings again.
- ❑ Select **Settings > General Settings > Network Settings > Connection Check**, and then print the network connection report. If an error has occurred, check the network connection report and then follow the printed solutions.

### Related Information

- ➔ [“Printing a Network Connection Report” on page 31](#)
- ➔ [“Messages and Solutions on the Network Connection Report” on page 32](#)

## Cannot Connect from Devices Even Though Network Settings are No Problems

If you cannot connect from the computer or smart device to the printer even though the network connection report does not show any problems, see the following.

- ❑ When you are using multiple access points at the same time, you may not be able to use the printer from the computer or smart device depending on the settings of the access points. Connect the computer or smart device to the same access point as the printer.

Disable the tethering function on the smart device if it is enabled.

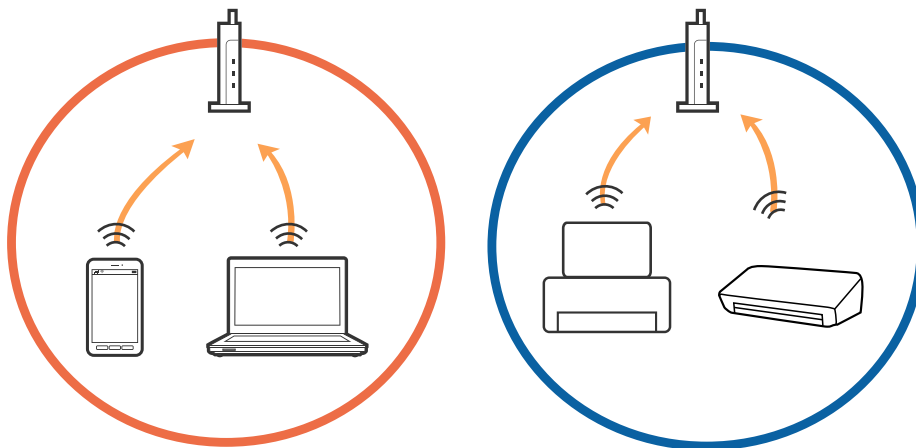

### Solving Problems

- ❑ You may not be able to connect to the access point when the access point has multiple SSIDs and devices are connected to different SSIDs on the same access point. Connect the computer or smart device to the same SSID as the printer.

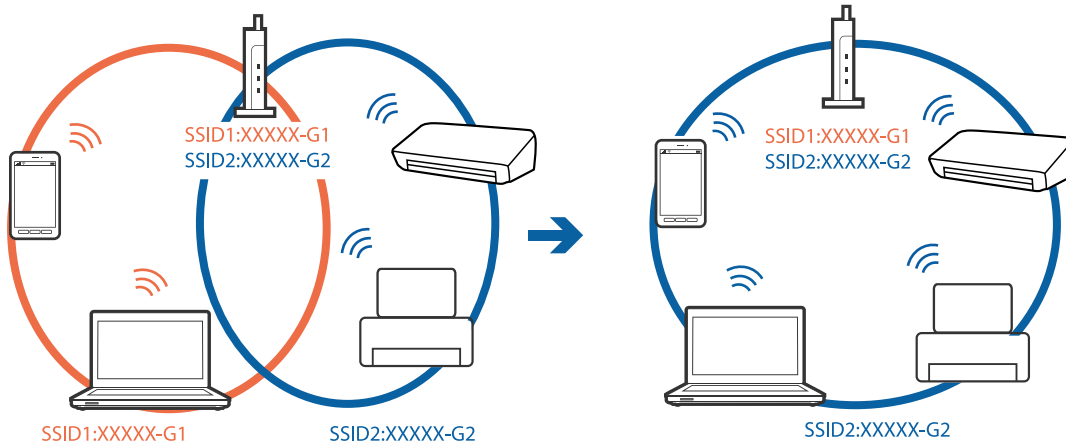

- ❑ An access point that is compliant with both IEEE802.11a and IEEE802.11g has SSIDs of 2.4 GHz and 5 GHz. If you connect the computer or smart device to a 5 GHz SSID, you cannot connect to the printer because the printer only supports communication over 2.4 GHz. Connect the computer or smart device to the same SSID as the printer.

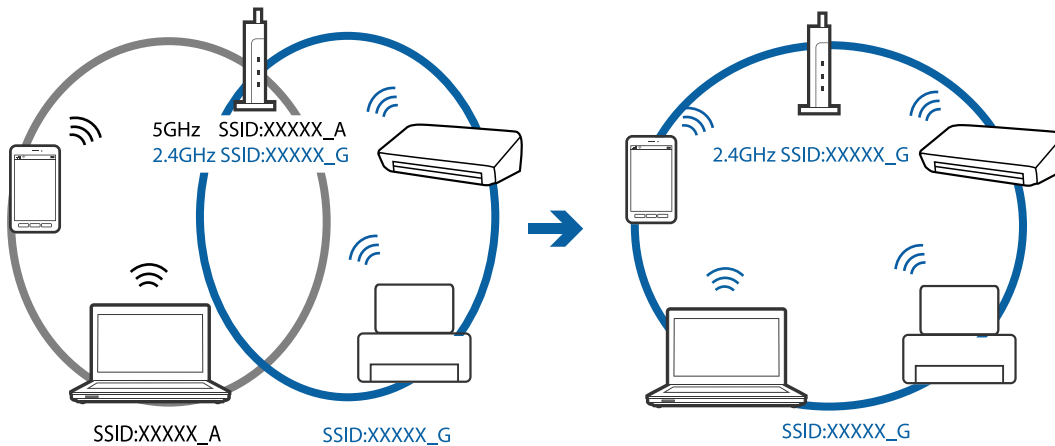

- ❑ Most access points have a privacy separator feature that blocks communication between connected devices. If you cannot communicate between the printer and the computer or smart device even if they are connected to the same network, disable the privacy separator on the access point. See the manual provided with the access point for details.

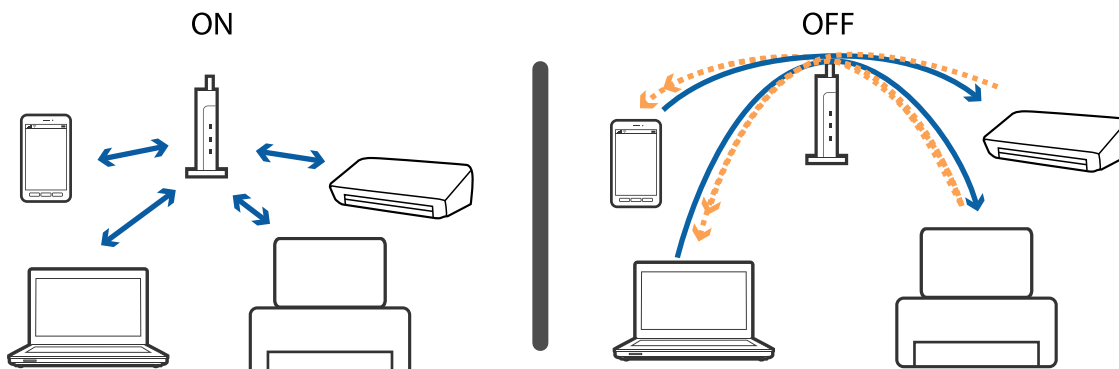

**Related Information**

- ➔ [“Checking the SSID Connected to the Printer” on page 191](#)
- ➔ [“Checking the SSID for the Computer” on page 191](#)

## Checking the SSID Connected to the Printer

Select **Settings > General Settings > Network Settings > Network Status**.

You can check the SSID for Wi-Fi and Wi-Fi Direct from each menu.

## Checking the SSID for the Computer

**Windows**

Click  in the task tray on the desktop. Check the name of the connected SSID from the list displayed.



## Solving Problems

### Mac OS

Click the Wi-Fi icon at the top of the computer screen. A list of SSIDs is displayed and the connected SSID is indicated with a check mark.



---

## Cannot Print from an iPhone or iPad

- Connect the iPhone or iPad to the same network (SSID) as the printer.
- Enable **Paper Setup Auto Display** in the following menus.  
**Settings > General Settings > Printer Settings > Paper Source Settings > Paper Setup Auto Display**
- Enable the AirPrint setting on Web Config.

### Related Information

- ➔ [“Connecting to a Smart Device” on page 24](#)
- ➔ [“Application for Configuring Printer Operations \(Web Config\)” on page 168](#)

---

## Printout Problems

### Printout is Scuffed or Color is Missing

If you have not used the printer for a long time, the print head nozzles may be clogged and ink drops may not be discharged. Perform a nozzle check, and then clean the print head if any of the print head nozzles are clogged.

### Related Information

- ➔ [“Checking and Cleaning the Print Head” on page 158](#)



## Banding or Unexpected Colors Appear

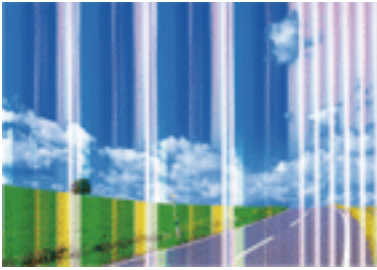

The print head nozzles may be clogged. Perform a nozzle check to check if the print head nozzles are clogged. Clean the print head if any of the print head nozzles are clogged.

### Related Information

➔ [“Checking and Cleaning the Print Head” on page 158](#)

## Colored Banding Appears at Intervals of Approximately 3.3 cm



- Select the appropriate paper type setting for the type of paper loaded in the printer.
- Align the print head using the **Horizontal Alignment** feature.
- When printing on plain paper, print using a higher quality setting.

### Related Information

➔ [“List of Paper Type” on page 48](#)

➔ [“Aligning the Print Head” on page 159](#)

## Blurry Prints, Vertical Banding, or Misalignment



enthalten alle  
Aufdruck. W  
5008 "Regel

Align the print head using the **Vertical Alignment** feature.

### Related Information

➔ [“Aligning the Print Head” on page 159](#)

## Print Quality Does Not Improve Even After Aligning the Print Head

During bidirectional (or high speed) printing, the print head prints while moving in both directions, and vertical lines may be misaligned. If print quality does not improve, disable the bidirectional (or high speed) setting. Disabling this setting may slow down printing speed.

### Windows

Clear **High Speed** on the printer driver's **More Options** tab.

### Mac OS

Select **System Preferences** from the  menu > **Printers & Scanners** (or **Print & Scan**, **Print & Fax**), and then select the printer. Click **Options & Supplies** > **Options** (or **Driver**). Select **Off** as the **High Speed Printing** setting.

## Print Quality is Poor

Check the following if the print quality is poor due to blurry prints, banding, missing colors, faded colors, and misalignment in the prints.

### Checking the printer

- Perform a nozzle check, and then clean the print head if any of the print head nozzles are clogged.
- Align the print head.

### Checking the paper

- Use paper supported by this printer.
- Do not print on paper that is damp, damaged, or too old.
- If the paper is curled or the envelope is puffed up, flatten it.
- Do not stack the paper immediately after printing.
- Dry the printouts completely before filing or displaying them. When drying the printouts, avoid direct sun light, do not use a dryer, and do not touch the printed side of paper.

## Solving Problems

- When printing images or photos, Epson recommends using genuine Epson paper rather than plain paper. Print on the printable side of the genuine Epson paper.

### Checking the print settings

- Select the appropriate paper type setting for the type of paper loaded in the printer.
- Print using a higher quality setting.

### Checking the ink cartridge

- Epson recommends using the ink cartridge before the date printed on the package.
- For best results, use up ink cartridge within six months of opening the package.
- Try to use genuine Epson ink cartridges. This product is designed to adjust colors based on the use of genuine Epson ink cartridges. The use of non-genuine ink cartridges may cause print quality to decline.

### Related Information

- ➔ [“Checking and Cleaning the Print Head” on page 158](#)
- ➔ [“Aligning the Print Head” on page 159](#)
- ➔ [“Available Paper and Capacities” on page 43](#)
- ➔ [“List of Paper Type” on page 48](#)
- ➔ [“Paper Handling Precautions” on page 44](#)

## Paper Is Smearred or Scuffed

- When horizontal banding appears or the top or bottom of the paper is smearred, load paper in the correct direction and slide the edge guides to the edges of the paper.

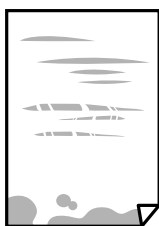

- When vertical banding appears or the paper is smearred, clean the paper path.



## Solving Problems

- ❑ When the problem cannot be cleared after cleaning the paper path, the part inside the printer that is shown in the illustration is smeared. Turn off the printer, and then wipe off the ink using a cotton swab.

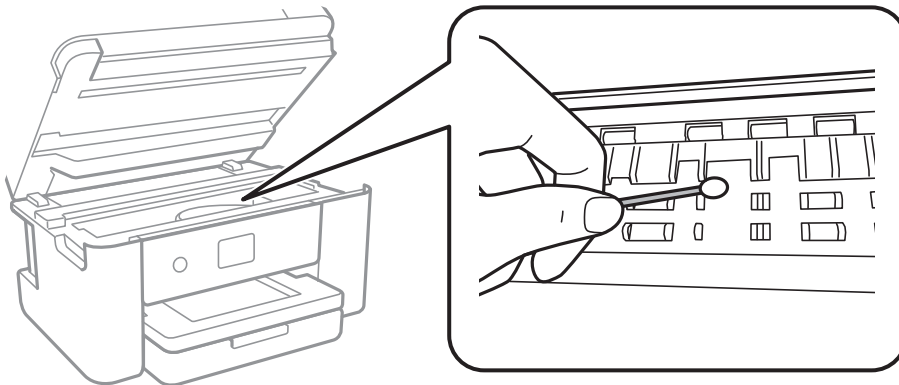

Do not touch the white flat cable, translucent film, and ink tubes inside the printer. Doing so may cause a malfunction.

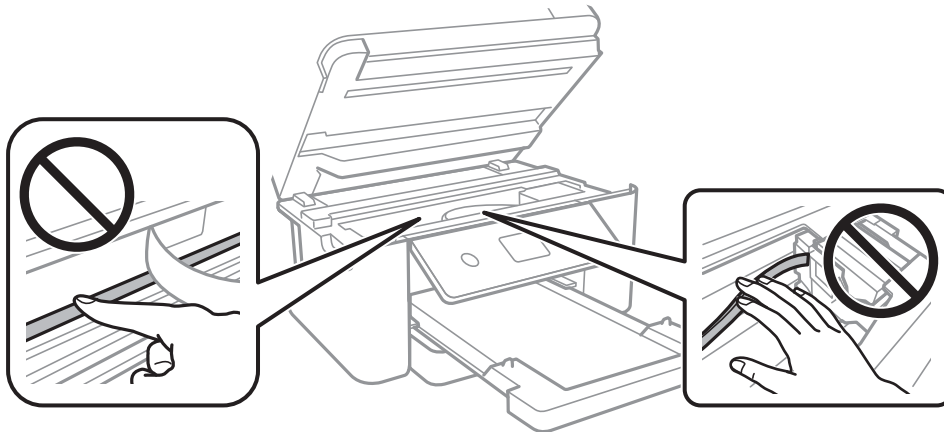

- ❑ Place the paper on a flat surface to check if it is curled. If it is, flatten it.
- ❑ When performing manual 2-sided printing, make sure that the ink is completely dry before reloading the paper.

### Related Information

- ➔ [“Loading Paper in the Paper Cassette” on page 45](#)
- ➔ [“Cleaning the Paper Path for Ink Smears” on page 161](#)

## Paper is Smeared During Automatic 2-Sided Printing

When using the automatic 2-sided printing feature and printing high density data such as images and graphs, set the print density to lower and the drying time to longer.

### Related Information

- ➔ [“Printer Settings” on page 57](#)

## Printed Photos are Sticky

You may be printing on the wrong side of the photo paper. Make sure you are printing on the printable side. When printing on the wrong side of the photo paper, you need to clean the paper path.

### Related Information

➔ [“Cleaning the Paper Path for Ink Smears” on page 161](#)

## Images or Photos are Printed in Unexpected Colors

When printing from the Windows printer driver, the Epson auto photo adjustment setting is applied by default depending on the paper type. Try change the setting.

On the **More Options** tab, select **Custom** in **Color Correction**, and then click **Advanced**. Change the **Scene Correction** setting from **Auto Correct** to any other option. If changing the setting does not work, use any color correction method other than **PhotoEnhance** in **Color Management**.

### Related Information

➔ [“Adjusting the Print Color” on page 78](#)

## Cannot Print Without Margins

Make borderless setting in the print settings. If you select a paper type that does not support borderless printing, you cannot select **Borderless**. Select a paper type that supports borderless printing.

### Related Information

➔ [“Advanced Menu Options for Copying” on page 96](#)

➔ [“Printing Basics” on page 64](#)

➔ [“Printing Basics” on page 82](#)

## Edges of the Image are Cropped During Borderless Printing

During borderless printing, the image is slightly enlarged and the protruding area is cropped. Select a smaller enlargement setting.

Control panel

Change the **Expansion** setting.

Windows

Click **Settings** next to the **Borderless** checkbox on the printer driver's **Main** tab, and then change the settings.

Mac OS

Change the **Expansion** setting from the print dialog's **Print Settings** menu.

### Related Information

➔ [“Advanced Menu Options for Copying” on page 96](#)

## Solving Problems

### The Position, Size, or Margins of the Printout Are Incorrect

- Load paper in the correct direction, and slide the edge guides against the edges of the paper.
- When placing the originals on the scanner glass, align the corner of the original with the corner indicated by a symbol on the frame of the scanner glass. If the edges of the copy are cropped off, move the original slightly away from the corner.
- When placing the originals on the scanner glass, clean the scanner glass and the document cover. If there is dust or stains on the glass, the copy area may extend to include the dust or stains, resulting in the wrong copying position or small images.
- Select the appropriate **Original Size** in the copy settings.
- Select the appropriate paper size setting.
- Adjust the margin setting in the application so that it falls within the printable area.

#### Related Information

- ➔ [“Loading Paper in the Paper Cassette” on page 45](#)
- ➔ [“Placing Originals on the Scanner Glass” on page 51](#)
- ➔ [“Cleaning the Scanner Glass” on page 164](#)
- ➔ [“Printable Area” on page 212](#)

### Printed Characters Are Incorrect or Garbled

- Connect the USB cable securely to the printer and the computer.
- Cancel any paused print jobs.
- Do not put the computer manually into the **Hibernate** mode or the **Sleep** mode while printing. Pages of garbled text may be printed next time you start the computer.
- If you use the printer driver you had previously used, printed characters may be garbled. Make sure that the printer driver you are using is for this printer. Check the printer name on the top of the printer driver window.

### The Printed Image Is Inverted

Clear any mirror image settings in the printer driver or the application.

- Windows
  - Clear **Mirror Image** on the printer driver's **More Options** tab.
- Mac OS
  - Clear **Mirror Image** from the print dialog's **Print Settings** menu.

### Mosaic-Like Patterns in the Prints

When printing images or photos, print using high-resolution data. Images on websites are often low resolution although they look good enough on the display, and so print quality may decline.

## Uneven Colors, Smears, Dots, or Straight Lines Appear in the Copied Image

- Clean the paper path.
- Clean the scanner glass.
- Clean the ADF.
- Do not press too hard on the original or the document cover when you are placing the originals on the scanner glass.
- When the paper is smeared, lower the copy density setting.

### Related Information

- ➔ [“Cleaning the Paper Path for Ink Smears” on page 161](#)
- ➔ [“Cleaning the Scanner Glass” on page 164](#)
- ➔ [“Cleaning the ADF” on page 163](#)
- ➔ [“Basic Menu Options for Copying” on page 96](#)

## Moiré (Cross-Hatch) Patterns Appear in the Copied Image

Change the reduce and enlarge setting or place the original at a slightly different angle.

### Related Information

- ➔ [“Basic Menu Options for Copying” on page 96](#)

## An Image of the Reverse Side of the Original Appears in the Copied Image

- For a thin original, place the original on the scanner glass and then place a piece of black paper over it.
- Lower the copy density setting on the control panel.

### Related Information

- ➔ [“Basic Menu Options for Copying” on page 96](#)

## The Printout Problem Could Not be Cleared

If you have tried all of the solutions and have not solved the problem, try uninstalling and then reinstalling the printer driver.



### Related Information

- ➔ [“Uninstalling Applications” on page 177](#)
- ➔ [“Installing the Latest Applications” on page 175](#)

---

## Other Printing Problems

### Printing Is Too Slow

- Close any unnecessary applications.
- Lower the quality setting. High quality printing slows down the printing speed.
- Enable the bidirectional (or high speed) setting. When this setting is enabled, the print head prints while moving in both directions, and the printing speed increases.
  - Windows  
Select **High Speed** on the printer driver's **More Options** tab.
  - Mac OS  
Select **System Preferences** from the  menu > **Printers & Scanners** (or **Print & Scan, Print & Fax**), and then select the printer. Click **Options & Supplies** > **Options** (or **Driver**). Select **On** as the **High Speed Printing** setting.
- Disable quiet mode. This feature slows down the printing speed.
  - Control Panel  
Select  on the home screen, and then disable **Quiet Mode**.
  - Windows  
Select **Off** as the **Quiet Mode** setting on the printer driver's **Main** tab.
  - Mac OS  
Select **System Preferences** from the  menu > **Printers & Scanners** (or **Print & Scan, Print & Fax**), and then select the printer. Click **Options & Supplies** > **Options** (or **Driver**). Select **Off** as the **Quiet Mode** setting.

### Printing Slows Down Dramatically During Continuous Printing

Printing slows down to prevent the printer mechanism from overheating and being damaged. However, you can continue printing. To return to normal printing speed, leave the printer idle for at least 30 minutes. Printing speed does not return to normal if the power is off.

### Cannot Cancel Printing from a Computer Running Mac OS X v10.6.8

If you want to stop printing from your computer, make the following settings.

Run Web Config, and then select **Port9100** as the **Top Priority Protocol** setting in **AirPrint Setup**. Select **System Preferences** from the  menu > **Printers & Scanners** (or **Print & Scan, Print & Fax**), remove the printer, and then add the printer again.

---

## Cannot Start Scanning

- If you are scanning with the ADF, check that the document cover and ADF cover are closed.



## Solving Problems

- You cannot use ADF when scanning from **Photo Mode** in Epson Scan 2.
- Connect the USB cable securely to the printer and the computer. If you are using a USB hub, try to connect the printer directly to the computer.
- If you scan at a high resolution over a network, a communication error may occur. Lower the resolution.
- Make sure that the correct printer (scanner) is selected on Epson Scan 2.

### Check whether or not the printer is recognized when using Windows

In Windows, make sure the printer (scanner) is displayed in **Scanner and Camera**. The printer (scanner) should be displayed as "EPSON XXXXX (printer name)". If the printer (scanner) is not displayed, uninstall and then re-install Epson Scan 2. See the following to access **Scanner and Camera**.

- Windows 10  
Right-click the start button or press and hold it, select **Control Panel**, enter "Scanner and Camera" in the search charm, click **View scanners and cameras**, and then check if the printer is displayed.
- Windows 8.1/Windows 8/Windows Server 2012 R2/Windows Server 2012  
Select **Desktop > Settings > Control Panel**, enter "Scanner and Camera" in the search charm, click **Show Scanner and Camera**, and then check if the printer is displayed.
- Windows 7/Windows Server 2008 R2  
Click the start button and select **Control Panel**, enter "Scanner and Camera" in the search charm, click **View scanners and cameras**, and then check if the printer is displayed.
- Windows Vista/Windows Server 2008  
Click the start button, select **Control Panel > Hardware and Sound > Scanners and Cameras**, and then check if the printer is displayed.
- Windows XP/Windows Server 2003 R2/Windows Server 2003  
Click the start button, select **Control Panel > Printers and Other Hardware > Scanner and Cameras**, and then check if the printer is displayed.

### Related Information

- ➔ ["Uninstalling Applications" on page 177](#)
- ➔ ["Installing the Latest Applications" on page 175](#)

---

## Scanned Image Problems

### Uneven Colors, Dirt, Spots, and so on Appear when Scanning from the Scanner Glass

- Clean the scanner glass.
- Remove any trash or dirt that adheres to the original.
- Do not press with too much force on the original or the document cover. If you press with too much force, blurring, smudges, and spots may occur.

## Solving Problems

### Related Information

- ➔ [“Cleaning the Scanner Glass” on page 164](#)

## Straight Lines Appear when Scanning from ADF

- Clean the ADF.

Straight lines may appear in the image when trash or dirt gets into the ADF.

- Remove any trash or dirt that adheres to the original.

### Related Information

- ➔ [“Cleaning the ADF” on page 163](#)

## The Image Quality Is Rough

- Set the **Mode** in Epson Scan 2 according to the original you want to scan. Scan using the settings for documents in **Document Mode**, and the settings for photos in **Photo Mode**.
- In Epson Scan 2, adjust the image using items on the **Advanced Settings** tab, and then scan.
- If the resolution is low, try increasing the resolution and then scanning.

### Related Information

- ➔ [“Scanning Using Epson Scan 2” on page 107](#)

## Offset Appears in the Background of Images

Images on the back of the original may appear in the scanned image.

- In Epson Scan 2, select the **Advanced Settings** tab, and then adjust the **Brightness**.  
This feature may not be available depending on the settings on the **Main Settings** tab > **Image Type** or other settings on the **Advanced Settings** tab.
- In **Document Mode** in Epson Scan 2, select the **Advanced Settings** tab, and then **Image Option** > **Text Enhancement**.
- When scanning from the scanner glass, place black paper or a desk pad over the original.

### Related Information

- ➔ [“Scanning Using Epson Scan 2” on page 107](#)
- ➔ [“Placing Originals” on page 49](#)

## Text is Blurred

- In **Document Mode** in Epson Scan 2, select the **Advanced Settings** tab, and then **Image Option** > **Text Enhancement**.

## Solving Problems

- ❑ Select **Document Mode** as the **Mode** in Epson Scan 2. Scan using the settings for documents in **Document Mode**.
- ❑ In **Document Mode** in Epson Scan 2, when **Image Type** on the **Main Settings** tab is set to **Black & White**, adjust **Threshold** on the **Advanced Settings** tab. When you increase the **Threshold**, the black color area becomes larger.
- ❑ If the resolution is low, try increasing the resolution and then scanning.

### Related Information

- ➔ [“Scanning Using Epson Scan 2” on page 107](#)

## Moiré Patterns (Web-Like Shadows) Appear

If the original is a printed document, moiré patterns (web-like shadows) may appear in the scanned image.

- ❑ On the **Advanced Settings** tab in Epson Scan 2, set **Descreening**.



- ❑ Change the resolution, and then scan again.

### Related Information

- ➔ [“Scanning Using Epson Scan 2” on page 107](#)

## Cannot Scan the Correct Area on the Scanner Glass

- ❑ Make sure the original is placed correctly against the alignment marks.
- ❑ If the edge of the scanned image is missing, move the original slightly away from the edge of the scanner glass.
- ❑ When placing multiple originals on the scanner glass, make sure there is a gap of at least 20 mm (0.79 in.) between the originals.
- ❑ When scanning from the control panel and selecting the auto scan area cropping function, remove any trash or dirt from the scanner glass and document cover. If there is any trash or dirt around the original, the scanning range expands to include it.

### Related Information

- ➔ [“Placing Originals” on page 49](#)
- ➔ [“Cleaning the Scanner Glass” on page 164](#)

## Solving Problems

### Text is Not Recognized Correctly when Saving as a Searchable PDF

- On the **Image Format Options** window in Epson Scan 2, check that **Text Language** is set correctly on the **Text** tab.
- Check that the original is placed straight.
- Use an original with clear text. Text recognition may decline for the following types of originals.
  - Originals that have been copied a number of times
  - Originals received by fax (at low resolutions)
  - Originals on which the letter spacing or line spacing is too small
  - Originals with ruled lines or underlining over the text
  - Originals with hand-written text
  - Originals with creases or wrinkles
- In **Document Mode** in Epson Scan 2, when **Image Type** on the **Main Settings** tab is set to **Black & White**, adjust **Threshold** on the **Advanced Settings** tab. When you increase the **Threshold**, black becomes stronger.
- In **Document Mode** in Epson Scan 2, select the **Advanced Settings** tab, and then **Image Option > Text Enhancement**.

#### Related Information

- ➔ [“Scanning Using Epson Scan 2” on page 107](#)

### Cannot Solve Problems in the Scanned Image

If you have tried all of the solutions and have not solved the problem, initialize the Epson Scan 2 settings using Epson Scan 2 Utility.

#### Note:

*Epson Scan 2 Utility is an application that comes with Epson Scan 2.*

1. Start Epson Scan 2 Utility.
  - Windows 10/Windows Server 2016  
Click the start button, and then select **EPSON > Epson Scan 2 Utility**.
  - Windows 8.1/Windows 8/Windows Server 2012 R2/Windows Server 2012  
Enter the application name in the search charm, and then select the displayed icon.
  - Windows 7/Windows Vista/Windows XP/Windows Server 2008 R2/Windows Server 2008/Windows Server 2003 R2/Windows Server 2003  
Click the start button, and then select **All Programs** or **Programs > EPSON > Epson Scan 2 > Epson Scan 2 Utility**.
  - Mac OS  
Select **Go > Applications > Epson Software > Epson Scan 2 Utility**.
2. Select the **Other** tab.

## Solving Problems

3. Click **Reset**.

**Note:**

*If initialization does not solve the problem, uninstall and re-install Epson Scan 2.*

### Related Information

- ➔ [“Uninstalling Applications” on page 177](#)
- ➔ [“Installing the Latest Applications” on page 175](#)

---

## Other Scanning Problems

### Scanning Is Too Slow

Lower the resolution.

### Related Information

- ➔ [“Scanning Using Epson Scan 2” on page 107](#)

### Scanning Stops when Scanning to PDF/Multi-TIFF

- When scanning using Epson Scan 2, you can continuously scan up to 999 pages in PDF format and up to 200 pages in Multi-TIFF format.
- When scanning large volumes, we recommend scanning in grayscale.
- Increase the free space on the computer's hard disk. Scanning may stop if there is not enough free space.
- Try scanning at a lower resolution. Scanning stops if the total data size reaches the limit.

### Related Information

- ➔ [“Scanning Using Epson Scan 2” on page 107](#)

---

## Problems when Sending and Receiving Faxes

### Cannot Send or Receive Faxes

- Use **Check Fax Connection** on the control panel to run the automatic fax connection check. Try the solutions printed on the report.
- Check the **Line Type** setting. Setting to **PBX** may solve the problem. If your phone system requires an external access code to get an outside line, register the access code to the printer, and enter # (hash) at the beginning of a fax number when sending.
- If a communication error occurs, change the **Fax Speed** setting to **Slow(9,600bps)** on the control panel.
- Check that the telephone wall jack works by connecting a phone to it and testing it. If you cannot make or receive calls, contact your telecommunication company.

## Solving Problems



- ❑ To connect to a DSL phone line, you need to use a DSL modem equipped with a built-in DSL filter, or install a separate DSL filter to the line. Contact your DSL provider.
- ❑ If you are connecting to a DSL phone line, connect the printer directly to a telephone wall jack to see if the printer can send a fax. If it works, the problem may be caused by the DSL filter. Contact your DSL provider.
- ❑ Enable the **ECM** setting on the control panel. Color faxes cannot be sent or received when **ECM** is off.
- ❑ To send or receive faxes using the computer, make sure that the printer is connected using a USB cable or a network, and that the PC-FAX Driver have been installed on the computer. The PC-FAX Driver is installed together with FAX Utility.
- ❑ In Windows, make sure the printer (fax) is displayed in **Devices and Printers**, **Printer**, or **Printers and Other Hardware**. The printer (fax) is displayed as "EPSON XXXXX (FAX)". If the printer (fax) is not displayed, uninstall and then re-install the FAX Utility. See the following to access **Devices and Printers**, **Printer**, or **Printers and Other Hardware**.
  - ❑ Windows 10
 

Right-click on the start button, or press and hold it and then select **Control Panel > View devices and printers** in **Hardware and Sound**.
  - ❑ Windows 8.1/Windows 8
 

Select **Desktop > Settings > Control Panel > View devices and printers** in **Hardware and Sound** or **Hardware**.
  - ❑ Windows 7
 

Click the start button, and select **Control Panel > View devices and printers** in **Hardware and Sound** or **Hardware**.
  - ❑ Windows Vista
 

Click the start button, and select **Control Panel > Printers** in **Hardware and Sound**.
  - ❑ Windows XP
 

Click the start button, and select **Settings > Control Panel > Printers and Other Hardware > Printers and Faxes**.
- ❑ In Mac OS, check the following.
  - ❑ Select **System Preferences** from the  menu > **Printers & Scanners** (or **Print & Scan**, **Print & Fax**), and then make sure the printer (fax) is displayed. The printer (fax) is displayed as "FAX XXXX (USB)" or "FAX XXXX (IP)". If the printer (fax) is not displayed, click [+] and then register the printer (fax).
  - ❑ Select **System Preferences** from the  menu > **Printers & Scanners** (or **Print & Scan**, **Print & Fax**), and then double-click the printer (fax). If the printer is paused, click **Resume** (or **Resume Printer**).

### Related Information

- ➔ [“Check Fax Connection” on page 143](#)
- ➔ [“Basic Settings” on page 146](#)
- ➔ [“Making Settings for a PBX Phone System” on page 122](#)
- ➔ [“Connecting the Printer to a Phone Line” on page 117](#)
- ➔ [“Uninstalling Applications” on page 177](#)
- ➔ [“Installing the Latest Applications” on page 175](#)

## Solving Problems

### Cannot Send Faxes



- ❑ Set up the header information for outgoing faxes on the control panel. Some fax machines automatically reject incoming faxes that do not include header information.
- ❑ If you have blocked your caller ID, unblock it. Some phones or fax machines automatically reject anonymous calls.
- ❑ Ask the recipient if the fax number is correct and the recipient's fax machine is ready to receive a fax.

#### Related Information

- ➔ [“Basic Settings” on page 146](#)
- ➔ [“Cannot Send or Receive Faxes” on page 205](#)

### Cannot Send Faxes to a Specific Recipient

Check the following if you cannot send faxes to a specific recipient due to an error.

- ❑ If the recipient machine does not pick up your call within 50 seconds after the printer has finished dialing, the call ends with an error. Dial using a connected telephone to check how long it takes before you hear a fax tone. If it takes more than 50 seconds, add pauses after the fax number to send the fax. The  is used to enter pauses. A hyphen is entered as the pause mark. One pause is about three seconds. Add multiple pauses as needed.
- ❑ If you have selected the recipient from the contacts list, verify that the registered information is correct. If the information is correct, select the recipient from the contacts list, tap  > **Edit**, and then change **Fax Communication Mode** to **Slow(9,600bps)**.

#### Related Information

- ➔ [“Sending Faxes Dialing from the External Phone Device” on page 125](#)
- ➔ [“Managing Contacts” on page 53](#)
- ➔ [“Cannot Send or Receive Faxes” on page 205](#)

### Cannot Send Faxes at a Specified Time

Set the date and the time correctly on the control panel.

#### Related Information

- ➔ [“Sending Faxes at a Specified Time \(Send Fax Later\)” on page 126](#)
- ➔ [“Basic Settings” on page 56](#)

### Cannot Receive Faxes

- ❑ If you have subscribed to a call forwarding service, the printer may not be able to receive faxes. Contact the service provider.
- ❑ If you have not connected a telephone to the printer, set the **Receive Mode** setting to **Auto** on the control panel.

## Solving Problems

- ❑ Under the following conditions, the printer runs out of memory and cannot receive faxes. See the troubleshooting for information on handling a memory full error.
  - ❑ The number of received documents has reached the maximum of 100 documents.
  - ❑ The printer's memory is full (100%).
- ❑ Check if the sender's fax number has been registered to the **Rejection Number List**. Faxes sent from numbers that have been added to this list are blocked when **Rejection Number List** in **Rejection Fax** is enabled.
- ❑ Ask the sender if header information is set up on their fax machine. Faxes that do not include header information are blocked when **Fax Header Blank** in **Rejection Fax** is enabled.
- ❑ Check if the sender's fax number is registered in the contacts list. Faxes sent from numbers that have not been registered to this list are blocked when **Unregistered Contacts** in **Rejection Fax** is enabled.

### Related Information

- ➔ [“Basic Settings” on page 146](#)
- ➔ [“Cannot Send or Receive Faxes” on page 205](#)
- ➔ [“Memory Full Error Occurs” on page 208](#)

## Memory Full Error Occurs

- ❑ If the printer has been set to save received faxes in the inbox, delete faxes you have already read from the inbox.
- ❑ If the printer has been set to save received faxes on a computer, turn on the computer that is set to save the faxes. Once the faxes are saved in the computer, they are deleted from the printer's memory.
- ❑ Even though the memory is full, you can send a monochrome fax by using the **Direct Send** feature. Or you can also send a fax by dialing from the external phone device.
- ❑ If the printer cannot print a received fax due to a printer error, such as a paper jam, the memory full error may occur. Clear the printer problem, and then contact the sender and ask them to send the fax again.

### Related Information

- ➔ [“Saving Received Faxes in the Inbox” on page 131](#)
- ➔ [“Sending Many Pages of a Monochrome Document \(Direct Send\)” on page 126](#)
- ➔ [“Sending Faxes Dialing from the External Phone Device” on page 125](#)
- ➔ [“Removing Jammed Paper” on page 182](#)

## Sent Fax Quality Is Poor

- ❑ Clean the scanner glass.
- ❑ Clean the ADF.
- ❑ Change the **Density** setting on the control panel.
- ❑ If you are not sure about the capabilities of the recipient fax machine, enable the **Direct Send** feature or select **Fine** as the **Resolution** setting.
- ❑ Enable the **ECM** setting on the control panel.



## Solving Problems

### Related Information

- ➔ [“Fax Settings” on page 141](#)
- ➔ [“Basic Settings” on page 146](#)
- ➔ [“Cleaning the Scanner Glass” on page 164](#)
- ➔ [“Cleaning the ADF” on page 163](#)

## Faxes Are Sent at the Wrong Size

- When sending a fax using the scanner glass, place the original correctly aligning its corner with the origin mark. Select your original size on the control panel.
- Clean the scanner glass and the document cover. If there is dust or stains on the glass, the scanning area may extend to include the dust or stains, resulting in the wrong scanning position or small images.

### Related Information

- ➔ [“Fax Settings” on page 141](#)
- ➔ [“Placing Originals” on page 49](#)
- ➔ [“Cleaning the Scanner Glass” on page 164](#)

## Received Fax Quality Is Poor

- Enable the ECM setting on the control panel.
- Contact the sender and ask them to send using a higher quality mode.
- Reprint the received fax. Select **Fax** >  > **Reprint Faxes** to reprint the fax.

### Related Information

- ➔ [“Basic Settings” on page 146](#)

## Received Faxes Are Not Printed

- If an error has occurred on the printer, such as a paper jam, the printer cannot print received faxes. Check the printer.
- If the printer has been set to save received faxes in the inbox, the received faxes are not automatically printed. Check the **Receive Settings**.

### Related Information

- ➔ [“Checking the Printer Status” on page 180](#)
- ➔ [“Removing Jammed Paper” on page 182](#)
- ➔ [“Saving Received Faxes in the Inbox” on page 131](#)

## Pages are Blank or only a Small Amount of Text is Printed on the Second Page in Received Faxes

You can print on one page by using the **Delete Print Data After Split** feature in **Split Page Settings**.

Select **Delete Top** or **Delete Bottom** in **Delete Print Data After Split**, and then adjust **Threshold**. Increasing the threshold increases the amount deleted; a higher threshold gives you a higher possibility of printing on one page.

### Related Information

➔ [“Print Settings” on page 144](#)

---

## Other Faxing Problems

### Cannot Make Calls on the Connected Telephone

Connect the telephone to the EXT. port on the printer, and pick up the receiver. If you cannot hear a dial tone through the receiver, connect the phone cable correctly.

### Related Information

➔ [“Connecting Your Phone Device to the Printer” on page 118](#)

### Answering Machine Cannot Answer Voice Calls

On the control panel, set the printer's **Rings to Answer** setting to a number higher than the number of rings for your answering machine.

### Related Information

➔ [“Basic Settings” on page 146](#)

➔ [“Settings for the Answering Machine” on page 129](#)

### Sender's Fax Number Not Displayed on Received Faxes or the Number Is Wrong

The sender may not have set the fax header information or may have set it incorrectly. Contact the sender.

---

## Other Problems

### Slight Electric Shock when Touching the Printer

If many peripherals are connected to the computer, you may feel a slight electric shock when touching the printer. Install a ground wire to the computer that is connected to the printer.

## Operation Sounds Are Loud

If operations sounds are too loud, enable **Quiet Mode**. Enabling this feature may reduce printing speed.

Control panel

Select  on the home screen, and then enable **Quiet Mode**.

Windows printer driver

Enable **Quiet Mode** on the **Main** tab.

Mac OS printer driver

Select **System Preferences** from the  menu > **Printers & Scanners** (or **Print & Scan, Print & Fax**), and then select the printer. Click **Options & Supplies** > **Options** (or **Driver**). Select **On** as the **Quiet Mode** setting.

## The Date and Time Are Incorrect

Set the date and the time correctly on the control panel. After a power failure caused by a lightning strike or if the power is left off for a long time, the clock may show the wrong time.

### Related Information

➔ [“Basic Settings” on page 56](#)

## Application Is Blocked by a Firewall (for Windows Only)

Add the application to the Windows Firewall allowed program in security settings on the **Control Panel**.

# Appendix

## Technical Specifications

### Printer Specifications

Print Head Nozzle Placement		Black ink nozzles: 400 Color ink nozzles: 128 for each color
Weight of Paper*	Plain Paper	64 to 90 g/m <sup>2</sup> (17 to 24lb)
	Envelopes	Envelope #10, DL, C6: 75 to 90 g/m <sup>2</sup> (20 to 24 lb)

\* Even when the paper thickness is within this range, the paper may not feed in the printer or the print quality may decline depending on the paper properties or quality.

### Printable Area

#### Printable Area for Single Sheets

Print quality may decline in the shaded areas due to the printer's mechanism.

#### Printing with borders

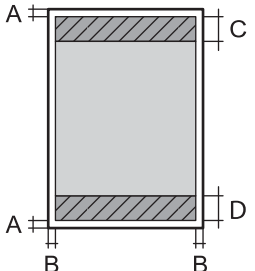
	A	3.0 mm (0.12 in.)
	B	3.0 mm (0.12 in.)
	C	41.0 mm (1.61 in.)
	D	37.0 mm (1.46 in.)

#### Borderless printing

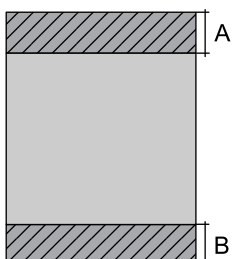
	A	44.0 mm (1.73 in.)
	B	40.0 mm (1.57 in.)

## Appendix

### Printable Area for Envelopes

Print quality may decline in the shaded areas due to the printer's mechanism.

	A	3.0 mm (0.12 in.)
	B	5.0 mm (0.20 in.)
	C	18.0 mm (0.70 in.)
	D	41.0 mm (1.61 in.)

### Scanner Specifications

Scanner Type	Flatbed
Photoelectric Device	CIS
Effective Pixels	10200×14040 pixels (1200 dpi)
Maximum Document Size	216×297 mm (8.5×11.7 in.) A4, Letter
Scanning Resolution	1200 dpi (main scan) 2400 dpi (sub scan)
Output Resolution	50 to 9600 dpi in 1 dpi increments
Color Depth	<p>Color</p> <ul style="list-style-type: none"> <li><input type="checkbox"/> 48 bits per pixel internal (16 bits per pixel per color internal)</li> <li><input type="checkbox"/> 24 bits per pixel external (8 bits per pixel per color external)</li> </ul> <p>Grayscale</p> <ul style="list-style-type: none"> <li><input type="checkbox"/> 16 bits per pixel internal</li> <li><input type="checkbox"/> 8 bits per pixel external</li> </ul> <p>Black and white</p> <ul style="list-style-type: none"> <li><input type="checkbox"/> 16 bits per pixel internal</li> <li><input type="checkbox"/> 1 bits per pixel external</li> </ul>
Light Source	LED

### Interface Specifications

For Computer	Hi-Speed USB
--------------	--------------

### Fax Specifications

Fax Type	Walk-up black and white and color fax capability (ITU-T Super Group 3)
----------	--

## Appendix

Supported Lines	Standard analogue telephone lines, PBX (Private Branch Exchange) telephone systems
Speed	Up to 33.6 kbps
Resolution	Monochrome <input type="checkbox"/> Standard: 8 pel/mm×3.85 line/mm (203 pel/in.×98 line/in.) <input type="checkbox"/> Fine: 8 pel/mm×7.7 line/mm (203 pel/in.×196 line/in.) <input type="checkbox"/> Photo: 8 pel/mm×7.7 line/mm (203 pel/in.×196 line/in.)  Color 200×200 dpi
Page Memory	Up to 100 pages (when received ITU-T No.1 chart in monochrome draft mode)
Redial*	2 times (with 1 minute intervals)
Interface	RJ-11 Phone Line, RJ-11 Telephone set connection

\* The specifications may differ by country or region.

## Network Function List

### Network Functions and IPv4/IPv6

Functions			Supported	Remarks
Network Printing	EpsonNet Print (Windows)	IPv4	✓	-
	Standard TCP/IP (Windows)	IPv4, IPv6	✓	-
	WSD Printing (Windows)	IPv4, IPv6	✓	Windows Vista or later
	Bonjour Printing (Mac OS)	IPv4, IPv6	✓	-
	IPP Printing (Windows, Mac OS)	IPv4, IPv6	✓	-
	UPnP Printing	IPv4	-	Information appliance
	PictBridge Printing (Wi-Fi)	IPv4	-	Digital camera
	Epson Connect (Email Print, Remote Print)	IPv4	✓	-
	AirPrint (iOS, Mac OS)	IPv4, IPv6	✓	iOS 5 or later, Mac OS X v10.7 or later
	Google Cloud Print	IPv4, IPv6	✓	-

## Appendix

Functions		Supported	Remarks	
Network Scanning	Epson Scan 2	IPv4, IPv6	✓	-
	Event Manager	IPv4	✓	-
	Epson Connect (Scan to Cloud)	IPv4	✓	-
	AirPrint (Scan)	IPv4, IPv6	✓	OS X Mavericks or later
	ADF (2-sided scanning)		-	-
Fax	Send a fax	IPv4	✓	-
	Receive a fax	IPv4	✓	-
	AirPrint (Faxout)	IPv4, IPv6	✓	OS X Mountain Lion or later

## Wi-Fi Specifications

Standards	IEEE802.11b/g/n <sup>*1*</sup> 2
Frequency Range	2.4 GHz
Maximum Radio-Frequency Power Transmitted	19.8 dBm (EIRP)
Coordination Modes	Infrastructure, Wi-Fi Direct (Simple AP) <sup>*3</sup>
Wireless Securities	WEP (64/128bit), WPA2-PSK (AES) <sup>*4</sup>

\*1 Complies with either IEEE 802.11b/g/n or IEEE 802.11b/g depending on location of purchase.

\*2 IEEE802.11n is only available for the HT20.

\*3 Not supported for IEEE 802.11b.

\*4 Complies with WPA2 standards with support for WPA/WPA2 Personal.

## Ethernet Specifications

Standards	IEEE802.3i (10BASE-T) <sup>*1</sup> IEEE802.3u (100BASE-TX) IEEE802.3az (Energy Efficient Ethernet) <sup>*2</sup>
Communication Mode	Auto, 10Mbps Full duplex, 10Mbps Half duplex, 100Mbps Full duplex, 100Mbps Half duplex
Connector	RJ-45

\*1 Use a category 5e or higher STP (Shielded twisted pair) cable to prevent risk of radio interference.

\*2 The connected device should comply with IEEE802.3az standards.

## Appendix

## Security Protocol

SSL/TLS	HTTPS Server/Client, IPPS
---------	---------------------------

## Supported Third Party Services

AirPrint	Print	iOS 5 or later/Mac OS X v10.7.x or later
	Scan	OS X Mavericks or later
	Fax	OS X Mountain Lion or later
Google Cloud Print		

## Dimensions

Dimensions	<p>Storage</p> <ul style="list-style-type: none"> <li><input type="checkbox"/> Width: 375 mm (14.8 in.)</li> <li><input type="checkbox"/> Depth: 347 mm (13.7 in.)</li> <li><input type="checkbox"/> Height: 230 mm (9.1 in.)</li> </ul> <p>Printing</p> <ul style="list-style-type: none"> <li><input type="checkbox"/> Width: 417 mm (16.4 in.)</li> <li><input type="checkbox"/> Depth: 503 mm (19.8 in.)</li> <li><input type="checkbox"/> Height: 255 mm (10.0 in.)</li> </ul>
Weight*	Approx. 6.4 kg (14.1 lb)

\* Without the ink cartridges and the power cord.

## Electrical Specifications

Model	100 to 240 V Model	220 to 240 V Model
Rated Frequency Range	50 to 60 Hz	50 to 60 Hz
Rated Current	0.4 to 0.2 A	0.2 A
Power Consumption (with USB Connection)	<p>Standalone copying: Approx. 12.0 W (ISO/IEC24712)</p> <p>Ready mode: Approx. 5.4 W</p> <p>Sleep mode: Approx. 1.0 W</p> <p>Power off: Approx. 0.2 W</p>	<p>Standalone copying: Approx. 12.0 W (ISO/IEC24712)</p> <p>Ready mode: Approx. 5.4 W</p> <p>Sleep mode: Approx. 1.0 W</p> <p>Power off: Approx. 0.3 W</p>



## Appendix

**Note:**

- Check the label on the printer for its voltage.
- For European users, see the following Website for details on power consumption.  
<http://www.epson.eu/energy-consumption>

## Environmental Specifications

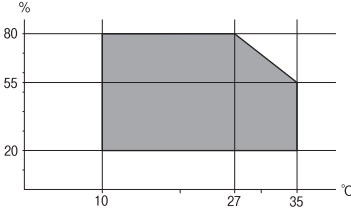
Operation	<p>Use the printer within the range shown in the following graph.</p>  <p>Temperature: 10 to 35°C (50 to 95°F) Humidity: 20 to 80% RH (without condensation)</p>
Storage	<p>Temperature: -20 to 40°C (-4 to 104°F)* Humidity: 5 to 85% RH (without condensation)</p>

\* You can store for one month at 40°C (104°F).

## Environmental Specifications for Ink Cartridges

Storage Temperature	-30 to 40 °C (-22 to 104 °F)*
Freezing Temperature	<p>-16 °C (3.2 °F) Ink thaws and is usable after approximately 3 hours at 25 °C (77 °F).</p>

\* You can store for one month at 40 °C (104 °F).

## System Requirements

- Windows 10 (32-bit, 64-bit)/Windows 8.1 (32-bit, 64-bit)/Windows 8 (32-bit, 64-bit)/Windows 7 (32-bit, 64-bit)/Windows Vista (32-bit, 64-bit)/Windows XP SP3 or later (32-bit)/Windows XP Professional x64 Edition SP2 or later/Windows Server 2016/Windows Server 2012 R2/Windows Server 2012/Windows Server 2008 R2/Windows Server 2008/Windows Server 2003 R2/Windows Server 2003 SP2 or later
- macOS High Sierra/macOS Sierra/OS X El Capitan/OS X Yosemite/OS X Mavericks/OS X Mountain Lion/Mac OS X v10.7.x/Mac OS X v10.6.8

**Note:**

- Mac OS may not support some applications and features.
- The UNIX File System (UFS) for Mac OS is not supported.

# Regulatory Information

## Standards and Approvals

### Standards and Approvals for U.S. Model

Safety	UL60950-1 CAN/CSA-C22.2 No.60950-1
EMC	FCC Part 15 Subpart B Class B CAN/CSA-CEI/IEC CISPR 22 Class B

This equipment contains the following wireless module.

Manufacturer: Askey Computer Corporation

Type: WLU6320-D69 (RoHS)

This product conforms to Part 15 of the FCC Rules and RSS-210 of the IC Rules. Epson cannot accept responsibility for any failure to satisfy the protection requirements resulting from a non-recommended modification of the product. Operation is subject to the following two conditions: (1) this device may not cause harmful interference, and (2) this device must accept any interference received, including interference that may cause undesired operation of the device.

To prevent radio interference to the licensed service, this device is intended to be operated indoors and away from windows to provide maximum shielding. Equipment (or its transmit antenna) that is installed outdoors is subject to licensing.

This equipment complies with FCC/IC radiation exposure limits set forth for an uncontrolled environment and meets the FCC radio frequency (RF) Exposure Guidelines in Supplement C to OET65 and RSS-102 of the IC radio frequency (RF) Exposure rules. This equipment should be installed and operated so that the radiator is kept at least 7.9 inches (20 cm) or more away from a person's body (excluding extremities: hands, wrists, feet and ankles).

### Standards and Approvals for European Model

For European users

Hereby, Seiko Epson Corporation declares that the following radio equipment model is in compliance with Directive 2014/53/EU. The full text of the EU declaration of conformity is available at the following website.

<http://www.epson.eu/conformity>

C623A

For use only in Ireland, UK, Austria, Germany, Liechtenstein, Switzerland, France, Belgium, Luxemburg, Netherlands, Italy, Portugal, Spain, Denmark, Finland, Norway, Sweden, Iceland, Croatia, Cyprus, Greece, Slovenia, Malta, Bulgaria, Czech, Estonia, Hungary, Latvia, Lithuania, Poland, Romania, and Slovakia.

Epson cannot accept responsibility for any failure to satisfy the protection requirements resulting from a non-recommended modification of the products.



## Appendix

### Standards and Approvals for Australian Model

EMC	AS/NZS CISPR32 Class B
-----	------------------------

Epson hereby declares that the following equipment Models are in compliance with the essential requirements and other relevant provisions of AS/NZS4268:

C623A

Epson cannot accept responsibility for any failure to satisfy the protection requirements resulting from a non-recommended modification of the products.

### German Blue Angel

See the following website to check whether or not this printer meets the standards for the German Blue Angel.

<http://www.epson.de/blauerengel>

### Restrictions on Copying

Observe the following restrictions to ensure the responsible and legal use of the printer.

Copying of the following items is prohibited by law:

- Bank bills, coins, government-issued marketable securities, government bond securities, and municipal securities
- Unused postage stamps, pre-stamped postcards, and other official postal items bearing valid postage
- Government-issued revenue stamps, and securities issued according to legal procedure

Exercise caution when copying the following items:

- Private marketable securities (stock certificates, negotiable notes, checks, etc.), monthly passes, concession tickets, etc.
- Passports, driver's licenses, warrants of fitness, road passes, food stamps, tickets, etc.

**Note:**

*Copying these items may also be prohibited by law.*

Responsible use of copyrighted materials:

Printers can be misused by improperly copying copyrighted materials. Unless acting on the advice of a knowledgeable attorney, be responsible and respectful by obtaining the permission of the copyright holder before copying published material.

---

## Transporting the Printer

When you need to transport the printer to move or for repairs, follow the steps below to pack the printer.



**Caution:**

*Be careful not to trap your hand or fingers when opening or closing the scanner unit. Otherwise you may be injured.*

## Appendix

**!** *Important:*

- ❑ *When storing or transporting the printer, avoid tilting it, placing it vertically, or turning it upside down; otherwise ink may leak.*
- ❑ *Leave the ink cartridges installed. Removing the cartridges can dry out the print head and may prevent the printer from printing.*

1. Turn off the printer by pressing the  button.
2. Make sure the power light turns off, and then unplug the power cord.

**!** *Important:*

*Unplug the power cord when the power light is off. Otherwise, the print head does not return to the home position causing the ink to dry, and printing may become impossible.*

3. Disconnect all cables such as the power cord and USB cable.
4. Remove all of the paper from the printer.
5. Make sure there are no originals on the printer.
6. Open the scanner unit with the document cover closed. Secure the ink cartridge holder to the case with tape.

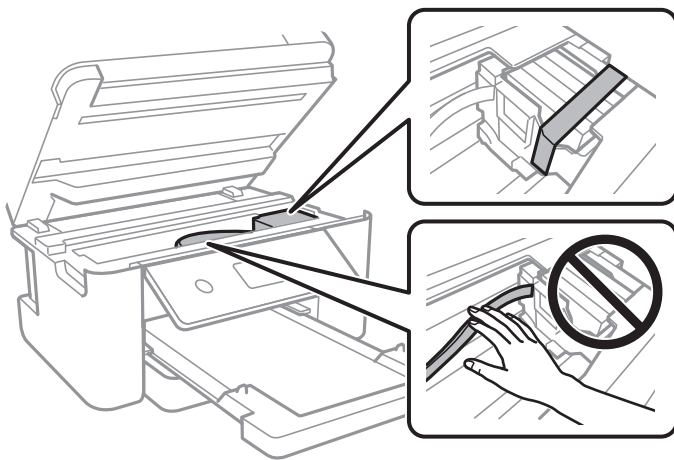

## Appendix

7. Close the scanner unit.

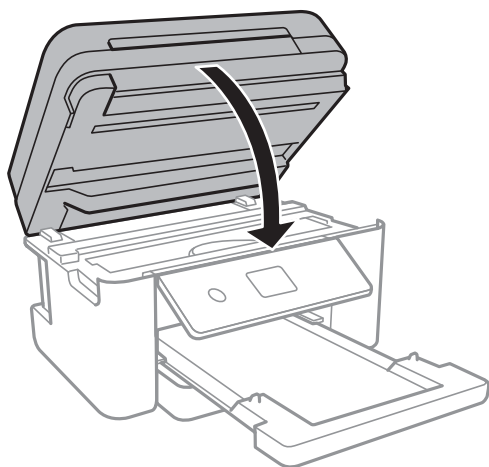

8. Prepare to pack the printer as shown below.

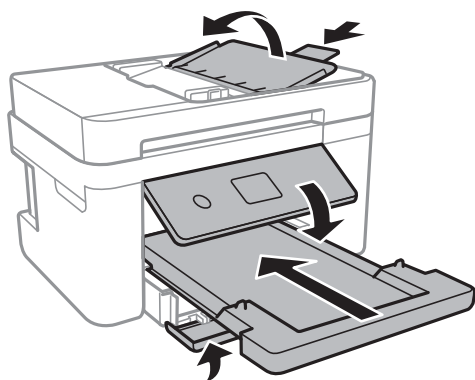

9. Pack the printer in its box, using the protective materials.

When you use the printer again, make sure you remove the tape securing the ink cartridge holder. If print quality has declined the next time you print, clean and align the print head.

**Related Information**

- ➔ [“Part Names and Functions” on page 14](#)
- ➔ [“Checking and Cleaning the Print Head” on page 158](#)
- ➔ [“Aligning the Print Head” on page 159](#)

---

## Copyright

No part of this publication may be reproduced, stored in a retrieval system, or transmitted in any form or by any means, electronic, mechanical, photocopying, recording, or otherwise, without the prior written permission of Seiko Epson Corporation. No patent liability is assumed with respect to the use of the information contained herein. Neither is any liability assumed for damages resulting from the use of the information herein. The information contained herein is designed only for use with this Epson product. Epson is not responsible for any use of this information as applied to other products.

## Appendix

Neither Seiko Epson Corporation nor its affiliates shall be liable to the purchaser of this product or third parties for damages, losses, costs, or expenses incurred by the purchaser or third parties as a result of accident, misuse, or abuse of this product or unauthorized modifications, repairs, or alterations to this product, or (excluding the U.S.) failure to strictly comply with Seiko Epson Corporation's operating and maintenance instructions.

Seiko Epson Corporation and its affiliates shall not be liable for any damages or problems arising from the use of any options or any consumable products other than those designated as Original Epson Products or Epson Approved Products by Seiko Epson Corporation.

Seiko Epson Corporation shall not be held liable for any damage resulting from electromagnetic interference that occurs from the use of any interface cables other than those designated as Epson Approved Products by Seiko Epson Corporation.

© 2017 Seiko Epson Corporation

The contents of this manual and the specifications of this product are subject to change without notice.

---

## Trademarks

- ❑ EPSON® is a registered trademark, and EPSON EXCEED YOUR VISION or EXCEED YOUR VISION is a trademark of Seiko Epson Corporation.
- ❑ PRINT Image Matching™ and the PRINT Image Matching logo are trademarks of Seiko Epson Corporation. Copyright © 2001 Seiko Epson Corporation. All rights reserved.
- ❑ Epson Scan 2 software is based in part on the work of the Independent JPEG Group.
- ❑ libtiff

Copyright © 1988-1997 Sam Leffler

Copyright © 1991-1997 Silicon Graphics, Inc.

Permission to use, copy, modify, distribute, and sell this software and its documentation for any purpose is hereby granted without fee, provided that (i) the above copyright notices and this permission notice appear in all copies of the software and related documentation, and (ii) the names of Sam Leffler and Silicon Graphics may not be used in any advertising or publicity relating to the software without the specific, prior written permission of Sam Leffler and Silicon Graphics.

THE SOFTWARE IS PROVIDED "AS-IS" AND WITHOUT WARRANTY OF ANY KIND, EXPRESS, IMPLIED OR OTHERWISE, INCLUDING WITHOUT LIMITATION, ANY WARRANTY OF MERCHANTABILITY OR FITNESS FOR A PARTICULAR PURPOSE.

IN NO EVENT SHALL SAM LEFFLER OR SILICON GRAPHICS BE LIABLE FOR ANY SPECIAL, INCIDENTAL, INDIRECT OR CONSEQUENTIAL DAMAGES OF ANY KIND, OR ANY DAMAGES WHATSOEVER RESULTING FROM LOSS OF USE, DATA OR PROFITS, WHETHER OR NOT ADVISED OF THE POSSIBILITY OF DAMAGE, AND ON ANY THEORY OF LIABILITY, ARISING OUT OF OR IN CONNECTION WITH THE USE OR PERFORMANCE OF THIS SOFTWARE.

- ❑ QR Code is a registered trademark of DENSO WAVE INCORPORATED in Japan and other countries.
- ❑ Intel® is a registered trademark of Intel Corporation.
- ❑ Microsoft®, Windows®, Windows Server®, and Windows Vista® are registered trademarks of Microsoft Corporation.
- ❑ Apple, Macintosh, macOS, OS X, Bonjour, ColorSync, Safari, AirPrint, the AirPrint Logo, iPad, iPhone, iPod touch, and iTunes are trademarks of Apple Inc., registered in the U.S. and other countries.
- ❑ Google Cloud Print, Chrome, Chrome OS, Google Play and Android are trademarks of Google Inc.
- ❑ Adobe and Adobe Reader are either registered trademarks or trademarks of Adobe Systems Incorporated in the United States and/or other countries.

- General Notice: Other product names used herein are for identification purposes only and may be trademarks of their respective owners. Epson disclaims any and all rights in those marks.

---

## Where to Get Help

### Technical Support Web Site

If you need further help, visit the Epson support website shown below. Select your country or region and go to the support section of your local Epson website. The latest drivers, FAQs, manuals, or other downloadables are also available from the site.

<http://support.epson.net/>

<http://www.epson.eu/Support> (Europe)

If your Epson product is not operating properly and you cannot solve the problem, contact Epson support services for assistance.

### Contacting Epson Support

#### Before Contacting Epson

If your Epson product is not operating properly and you cannot solve the problem using the troubleshooting information in your product manuals, contact Epson support services for assistance. If Epson support for your area is not listed below, contact the dealer where you purchased your product.

Epson support will be able to help you much more quickly if you give them the following information:

- Product serial number  
(The serial number label is usually on the back of the product.)
- Product model
- Product software version  
(Click **About**, **Version Info**, or a similar button in the product software.)
- Brand and model of your computer
- Your computer operating system name and version
- Names and versions of the software applications you normally use with your product

**Note:**

*Depending on the product, the dial list data for fax and/or network settings may be stored in the product's memory. Due to breakdown or repair of a product, data and/or settings may be lost. Epson shall not be responsible for the loss of any data, for backing up or recovering data and/or settings even during a warranty period. We recommend that you make your own backup data or take notes.*

#### Help for Users in Europe

Check your Pan-European Warranty Document for information on how to contact Epson support.

## Appendix

### Help for Users in Taiwan

Contacts for information, support, and services are:

#### World Wide Web

<http://www.epson.com.tw>

Information on product specifications, drivers for download, and products enquiry are available.

#### Epson HelpDesk

Phone: +886-2-80242008

Our HelpDesk team can help you with the following over the phone:

- Sales enquiries and product information
- Product usage questions or problems
- Enquiries on repair service and warranty

#### Repair service center:

<http://www.tekcare.com.tw/branchMap.page>

TekCare corporation is an authorized service center for Epson Taiwan Technology & Trading Ltd.

### Help for Users in Australia

Epson Australia wishes to provide you with a high level of customer service. In addition to your product manuals, we provide the following sources for obtaining information:

#### Internet URL

<http://www.epson.com.au>

Access the Epson Australia World Wide Web pages. Worth taking your modem here for the occasional surf! The site provides a download area for drivers, Epson contact points, new product information and technical support (e-mail).

#### Epson Helpdesk

Phone: 1300-361-054

Epson Helpdesk is provided as a final backup to make sure our clients have access to advice. Operators on the Helpdesk can aid you in installing, configuring and operating your Epson product. Our Pre-sales Helpdesk staff can provide literature on new Epson products and advise where the nearest dealer or service agent is located. Many types of queries are answered here.

We encourage you to have all the relevant information on hand when you ring. The more information you prepare, the faster we can help solve the problem. This information includes your Epson product manuals, type of computer, operating system, application programs, and any information you feel is required.

#### Transportation of Product

Epson recommends retaining product packaging for future transportation.



## Appendix

### Help for Users in New Zealand

Epson New Zealand wishes to provide you with a high level of customer service. In addition to your product documentation, we provide the following sources for obtaining information:

#### Internet URL

<http://www.epson.co.nz>

Access the Epson New Zealand World Wide Web pages. Worth taking your modem here for the occasional surf! The site provides a download area for drivers, Epson contact points, new product information and technical support (e-mail).

#### Epson Helpdesk

Phone: 0800 237 766

Epson Helpdesk is provided as a final backup to make sure our clients have access to advice. Operators on the Helpdesk can aid you in installing, configuring and operating your Epson product. Our Pre-sales Helpdesk staff can provide literature on new Epson products and advise where the nearest dealer or service agent is located. Many types of queries are answered here.

We encourage you to have all the relevant information on hand when you ring. The more information you prepare, the faster we can help solve the problem. This information includes your Epson product documentation, type of computer, operating system, application programs, and any information you feel is required.

#### Transportation of Product

Epson recommends retaining product packaging for future transportation.

### Help for Users in Singapore

Sources of information, support, and services available from Epson Singapore are:

#### World Wide Web

<http://www.epson.com.sg>

Information on product specifications, drivers for download, Frequently Asked Questions (FAQ), Sales Enquiries, and Technical Support via e-mail are available.

#### Epson HelpDesk

Toll Free: 800-120-5564

Our HelpDesk team can help you with the following over the phone:

- Sales enquiries and product information
- Product usage questions or problem troubleshooting
- Enquiries on repair service and warranty

### Help for Users in Hong Kong

To obtain technical support as well as other after-sales services, users are welcome to contact Epson Hong Kong Limited.

## Appendix

### Internet Home Page

<http://www.epson.com.hk>

Epson Hong Kong has established a local home page in both Chinese and English on the Internet to provide users with the following information:

- Product information
- Answers to Frequently Asked Questions (FAQs)
- Latest versions of Epson product drivers

### Technical Support Hotline

You can also contact our technical staff at the following telephone and fax numbers:

Phone: 852-2827-8911

Fax: 852-2827-4383